

## 阅读申明

- 1.本站收集的数据手册和产品资料都来自互联网，版权归原作者所有。如读者和版权方有任何异议请及时告之，我们将妥善解决。
- 2.本站提供的中文数据手册是英文数据手册的中文翻译，其目的是协助用户阅读，该译文无法自动跟随原稿更新，同时也可能存在翻译上的不当。建议读者以英文原稿为参考以便获得更精准的信息。
- 3.本站提供的产品资料，来自厂商的技术支持或者使用者的心得体会等，其内容可能存在描述上的差异，建议读者做出适当判断。
- 4.如需与我们联系，请发邮件到marketing@iczoom.com，主题请标有“数据手册”字样。

## Read Statement

1. The datasheets and other product information on the site are all from network reference or other public materials, and the copyright belongs to the original author and original published source. If readers and copyright owners have any objections, please contact us and we will deal with it in a timely manner.
2. The Chinese datasheets provided on the website is a Chinese translation of the English datasheets. Its purpose is for reader's learning exchange only and do not involve commercial purposes. The translation cannot be automatically updated with the original manuscript, and there may also be improper translations. Readers are advised to use the English manuscript as a reference for more accurate information.
3. All product information provided on the website refer to solutions from manufacturers' technical support or users the contents may have differences in description, and readers are advised to take the original article as the standard.
4. If you have any questions, please contact us at marketing@iczoom.com and mark the subject with "Datasheets" .

# Chip Resistor Arrays

## CRB Series (Concave Type)

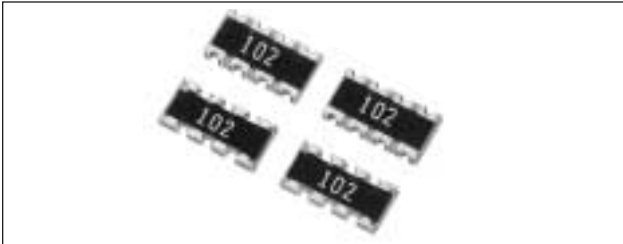

Chip Resistor Arrays have several resistor elements integrated as a single component.

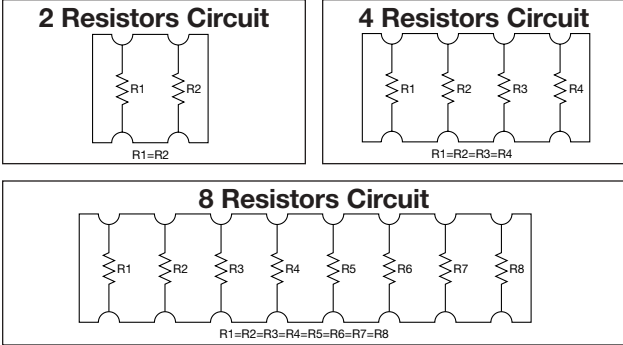

### FEATURES

- Reduction in mounting process & costs
- Save PCB space
- Reduction of inventory control costs

### APPLICATIONS

- Computer
- Hard Disk Drive
- Printer
- CD-ROM

### HOW TO ORDER

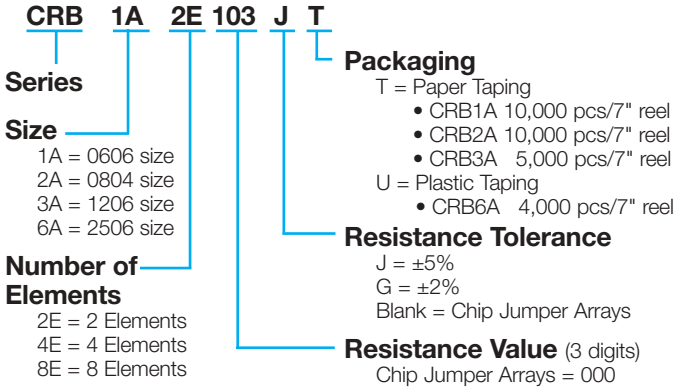

### RATING

Chip Resistor Arrays	
Item	Rating
Rated Power (70°C)*	1/16W Element
Max. Working Voltage	50V
Max. Overload Voltage	100V
Resistance Value	10Ω to 2.2MΩ (CRB6A 1MΩ max.)
Tolerance	J±5% (CRB6A G ± 2% only)
Working Temperature	-55 to +125°C

Chip Jumper Arrays	
Item	Rating
Rated Current	1A
Conductive Resistance Value	50MΩ max.
Resistance Value	Zero ohms (0 ± .5 ohms)
Working Temperature	-55 to +125°C

\*Rated voltage = 50V or  $\sqrt{\text{Rated power} \times \text{Resistance value}}$ , whichever is less

### DIMENSIONS

millimeters (inches)

Code	W	L	C	d	t	a	b	P	
<b>CRB1A2E</b>									
<b>Dim.</b>	1.60±0.15 (0.063±0.006)	1.60±0.20 (0.063±0.008)	0.30±0.20 (0.012±0.008)	0.40±0.15 (0.016±0.006)	0.60±0.10 (0.024±0.006)	0.50±0.15 (0.020±0.006)	0.30±0.10 (0.012±0.004)	0.80±0.10 (0.031±0.004)	
No Marking on chips									
Code	L	W	T	P	b	c	d	e	
<b>CRB2A4E</b>									
<b>Dim.</b>	2.00±0.10 (0.079±0.004)	1.00±0.10 (0.039±0.004)	0.40±0.10 (0.016±0.004)	0.50 typ (0.020 typ)	∅0.15 typ (∅0.006 typ)	0.20±0.15 (0.008±0.006)	0.25±0.015 (0.010±0.006)	0.25 typ (0.010 typ)	
Code	W	L	C	D	T	P			
<b>CRB3A4E</b>									
<b>Dim.</b>	1.60±0.15 (0.063±0.006)	3.20±0.15 (0.126±0.006)	0.30±0.20 (0.012±0.008)	0.40±0.15 (0.016±0.006)	0.60±0.10 (0.024±0.004)	0.80 typ (0.031 typ)			
Code	L	W	T	P	c	d	e (top)	e (bottom)	
<b>CRB6A8E</b>									
<b>Dim.</b>	6.40±0.20 (0.252±0.008)	1.60±0.20 (0.063±0.008)	0.60±0.10 (0.024±0.004)	0.80 typ (0.031 typ)	0.30±0.20 (0.012±0.008)	0.40±0.15 (0.016±0.006)	0.50±0.10 (0.020±0.004)	0.40±0.15 (0.016±0.006)	

Detailed specifications are available on request.

# Chip Resistor Arrays



## CR, CJ, CRA, CRB, CRC Series - Test Conditions

### ELECTRICAL CHARACTERISTICS

Item	Standard		Test Conditions												
	Resistor	Jumper	Resistor	Jumper											
<b>DC Resistance</b>	Within Initial Tolerance		Power Condition A (20°C, 65% RH)												
<b>Temperature Characteristics</b>	<table border="1"> <thead> <tr> <th>Resistance (<math>\Omega</math>)</th> <th>TCR (ppm/°C)</th> </tr> </thead> <tbody> <tr> <td><sup>*</sup>D, F 10 ≤ R ≤ 1M</td> <td>-100 to +100</td> </tr> <tr> <td>J, CR05 = F R &lt; 10</td> <td>-100 to +600</td> </tr> <tr> <td>10 ≤ R ≤ 1M</td> <td>-250 to +250</td> </tr> <tr> <td>1M &lt; R</td> <td>-500 to +300</td> </tr> </tbody> </table>		Resistance ( $\Omega$ )	TCR (ppm/°C)	<sup>*</sup> D, F 10 ≤ R ≤ 1M	-100 to +100	J, CR05 = F R < 10	-100 to +600	10 ≤ R ≤ 1M	-250 to +250	1M < R	-500 to +300	/	Test Temperature: 25, 125(°C) $\Delta R/R = R_2 - R_1 / R_1 \times 1 / T_2 - T_1 \times 10^6$ $\Delta R/R = \text{Temp. Coefficient}$ (ppm/°C) T <sub>1</sub> = 25(°C) T <sub>2</sub> = 125(°C) R <sub>1</sub> = T <sub>1</sub> Resistance at ( $\Omega$ ) R <sub>2</sub> = T <sub>2</sub> Resistance at ( $\Omega$ )	/
	Resistance ( $\Omega$ )	TCR (ppm/°C)													
<sup>*</sup> D, F 10 ≤ R ≤ 1M	-100 to +100														
J, CR05 = F R < 10	-100 to +600														
10 ≤ R ≤ 1M	-250 to +250														
1M < R	-500 to +300														
<b>Short-time Overload</b>	$\Delta R/R$	±(2.0%+0.10 $\Omega$ ) max. of the initial value	50m $\Omega$ max.	(1) Apply 2.0 x rated voltage for 5 sec. (2.5 x rated voltage for Arrays) (2) Wait 30 minutes (3) Measure resistance CR03 = 30V max. CR05 = 50V max. CR10 = 100V max. CR21 = 200V max. CR32 = 400V max. CRA3A, CRB3A, CRC3A = 100V max.	(1) 2A for 5 sec. (CJ03 = 1A) (2) Wait 30 minutes (3) Measure resistance										
<b>Intermittent Overload</b>	$\Delta R/R$	±(5%+0.1 $\Omega$ ) max. of the initial value	50m $\Omega$ max.	(1) Perform 10,000 voltage cycles as follows: ON (2.0 x rated voltage, 2.5 x for Arrays) 1 sec. OFF 25 sec. (2) Stabilization time 30 min. without loading (3) Measure resistance CR03 = 30V max. CR05 = 50V max. CR10 = 150V max. CR21 = 200V max. CR32 = 400V max. CRA, CRB, CRC = 100V max.	(1) Perform 10,000 current cycles as follows: ON (2A) 1 sec. OFF 25 sec. (2) Wait 30 minutes (3) Measure resistance CJ03 = 1A max.										
	<b>Visual</b>	No evidence of mechanical damage intermittent overload													
<b>Dielectric Withstanding Voltage</b>	No evidence of mechanical damage		Apply 500 VAC for 1 min. (CR10 300 VAC) (CR05, CRA3A, CRB3A, CRC3A 300 VAC/1 sec. CR03 50 VAC/min.)												
<b>Insulation Resistance</b>	<ul style="list-style-type: none"> <li>• CR03, CJ03 = 10<sup>8</sup><math>\Omega</math> min.</li> <li>• CR05, CJ05 = 10<sup>8</sup><math>\Omega</math> min.</li> <li>• CR10, CJ10 = 10<sup>9</sup><math>\Omega</math> min.</li> <li>• CR21, CJ21 = 10<sup>10</sup><math>\Omega</math> min.</li> <li>• CR32, CJ32 = 10<sup>12</sup><math>\Omega</math> min.</li> <li>• CRA3A, CRB3A, CRC3A = 10<sup>9</sup><math>\Omega</math> min.</li> </ul>		Apply 500V DC (CR05, CRA3A, CRB3A, CRC3A 100V DC CR03 50 VDC)												



# Chip Resistor Arrays



## CR, CJ, CRA, CRB, CRC Series - Test Conditions

### MECHANICAL CHARACTERISTICS

Item		Standard		Test Conditions	
		Resistor	Jumper	Resistor	Jumper
Terminal Strength	$\Delta R/R$	$\pm(1\%+0.05\Omega)$ max. of the initial value	50m $\Omega$ max.	Apply the load as shown: Measure resistance during load application	
	Visual	No evidence of mechanical damage after loading			
Soldering Heat Resistance	$\Delta R/R$	$\pm(1\%+0.05\Omega)$ max. of the initial value	50m $\Omega$ max.	Immerse into molten solder at $260\pm 5^\circ\text{C}$ for $10\pm 1$ sec. Stabilize component at room temperature for 1 hr. Measure resistance.	
	Visual	No evidence of leaching			
Solderability		Coverage $\geq 95\%$ each termination end		Immerse in Rogin Flux for $2\pm 0.5$ sec. and in SN62 solder at $235\pm 5^\circ\text{C}$ for $2\pm 0.5$ sec.	
Anti-Vibration Test	$\Delta R/R$	$\pm(1\%+0.1\Omega)$ max. of the initial value	50m $\Omega$ max.	2 hrs. each in X, Y and Z axis. (TTL 6 hrs.) 10 to 55 Hz sweep in 1 min. at 1.5mm amplitude.	
	Visual	No evidence of mechanical damage			
Solvent Resistance	$\Delta R/R$	$\pm(0.5\%+0.05\Omega)$ max. of the initial value	50m $\Omega$ max.	Immerse in static state butyl acetate at $20^\circ\text{C}$ to $25^\circ\text{C}$ for $30\pm 5$ sec. Stabilize component at room temperature for 30 min. then measure value.	
	Visual	No evidence of mechanical damage			

### ENVIRONMENTAL CHARACTERISTICS

Item		Standard		Test Conditions	
		Resistor	Jumper	Resistor	Jumper
Temperature Cycle	$\Delta R/R$	$\pm(1\%+0.05\Omega)$ max. of the initial value	50m $\Omega$ max.	(1) Run 5 cycles as follows: $-55\pm 3^\circ\text{C}$ for 30 min. $125\pm 3^\circ\text{C}$ for 30 min. Room temp. for 10-15 min. (2) Stabilize component at room temperature for 1 hr. then measure value.	
	Visual	No evidence of mechanical damage			
Low Temperature Storage	$\Delta R/R$	$\pm(2\%+0.1\Omega)$ max. of the initial value	50m $\Omega$ max.	(1) Dwell in $-55^\circ\text{C}$ chamber without loading for $1000^{+48}$ hrs. (2) Stabilize component at room temperature for 1 hr. then measure value.	
	Visual	No evidence of mechanical damage			
High Temperature Storage	$\Delta R/R$	$\pm(3\%+0.1\Omega)$ max. of the initial value	50m $\Omega$ max.	(1) Dwell in $125^\circ\text{C}$ chamber without loading for $1000^{+48}$ hrs. (2) Stabilize component at room temperature for 1 hr. then measure value.	
	Visual	No evidence of mechanical damage			
Moisture Resistance	$\Delta R/R$	$\pm(3\%+0.1\Omega)$ max. of the initial value	50m $\Omega$ max.	(1) Dwell in temp.: $65^\circ\text{C}$ RH90 to 95% RH chamber without loading for $1000^{+48}$ hrs. (2) Stabilize component at room temperature for 1 hr. then measure value.	
	Visual	No evidence of mechanical damage			
Life Test	$\Delta R/R$	$\pm(3\%+0.1\Omega)$ max. of the initial value	50m $\Omega$ max.	(1) Temp.: $70\pm 3^\circ\text{C}$ Voltage: (rated voltage) on 90 min. off 30 min. Duration: $1000^{+48}$ hrs. (2) Stabilize component at room temperature for 1 hr. then measure value.	
	Visual	No evidence of mechanical damage			
Loading Life in Moisture	$\Delta R/R$	$\pm(3\%+0.1\Omega)$ max. of the initial value	50m $\Omega$ max.	(1) Temp.: $40\pm 2^\circ\text{C}$ RH: 90-95% Voltage Cycle: on 90 min. (rated voltage) off 30 min. Duration: $1000^{+48}$ hrs. (2) Stabilize component at room temperature for 1 hr. then measure value.	
	Visual	No evidence of mechanical damage			

# Packaging of Chip Component



## Automatic Insertion Packaging

### TAPE AND REEL

#### REEL DIMENSIONS

millimeters (inches)

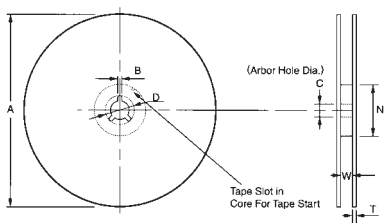

Tape Size	A Max.	B Min.	C	D Min.	N Min.	W	T Max.
8mm	178 (7)	1.50 (0.059)	13.0±0.50 (0.512±0.020)	20.2 (0.795)	50 (1.969)	10.0±1.50 (0.394±0.059)	2.50 (0.098)
	260 (10)						

Metric dimensions will govern.  
English measurements rounded and for reference only.

millimeters (inches)

#### PUNCHED TAPE CONFIGURATION 8MM TAPE ONLY

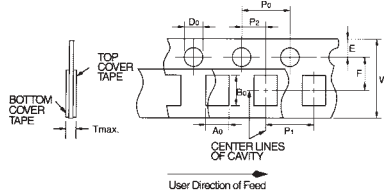

Tape Size	D <sub>0</sub>	E	P <sub>0</sub>	P <sub>2</sub>	W	F
8mm	1.50 <sup>+0.10</sup> / <sub>-0.004</sub> (0.059 <sup>+0.004</sup> / <sub>-0.000</sub> )	1.75±0.10 (0.069±0.004)	4.0±0.10 (0.157±0.004)	2.00±0.05 (0.079±0.002)	8.00±0.20 (0.135±0.008)	3.50±0.05 (0.138±0.002)

#### VARIABLE DIMENSIONS

Style	P <sub>1</sub>	A <sub>0</sub>	B <sub>0</sub>	T max.
CR/CJ03 CR/CJ05	2.00±0.10 (0.079±0.004)	0.65±0.10 (0.026±0.004)	1.15±0.10 (0.045±0.004)	0.60 (0.024)
CR/CJ/FR10	4.00±0.10 (0.157±0.004) or 2.00±0.10 (0.079±0.004)	1.10±0.20 (0.043±0.008)	1.90±0.20 (0.075±0.008)	1.10 (0.043)
CR/CJ/FR21	4.00±0.10 (0.157±0.004)	1.65±0.20 (0.065±0.008)	2.40±0.20 (0.094±0.008)	
CR/CJ/FR32		2.00±0.20 (0.079±0.008)	3.60±0.20 (0.142±0.008)	
CRB1A		1.90±0.20 (0.075±0.008)	1.90±0.20 (0.075±0.008)	
CRA3A CRB3A CRC3A		2.00±0.20 (0.079±0.008)	3.60±0.20 (0.142±0.008)	
CRB2A		2.00±0.10 (0.079±0.004)	1.25±0.20 (0.049±0.008)	

#### PUNCHED CARRIER

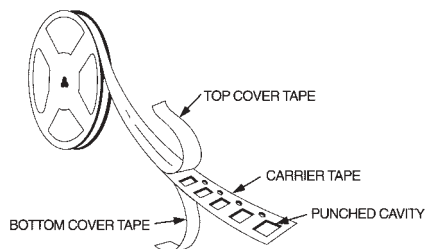

## RECOMMENDED LAND PATTERNS IS REFERRED THE FOLLOWING FOR EXAMPLE

millimeters (inches)

**CRA3A4E Series**

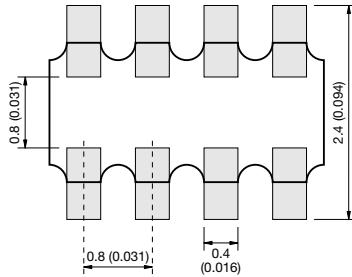

**RNA4A8E Series**

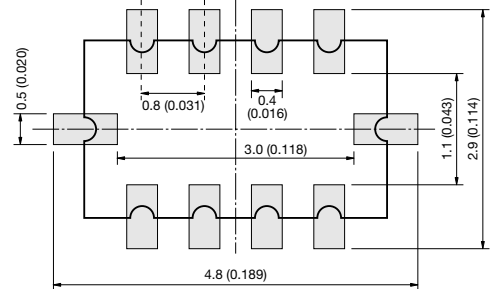

**CRB1A2E Series**

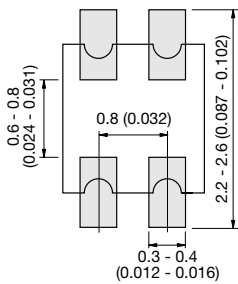

**CRB3A4E Series**

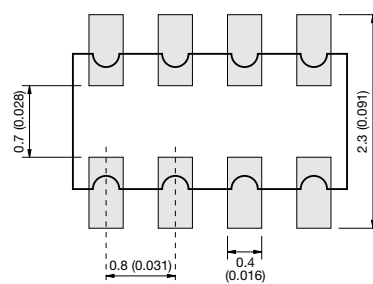

**CRB2A4E Series**

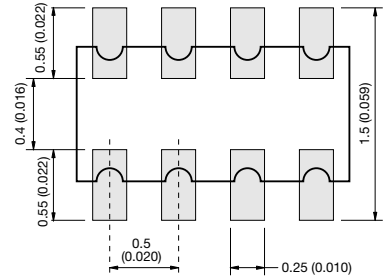

**CRC3A4E Series**

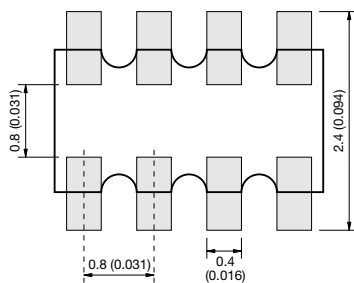

**CRC2A4E Series**

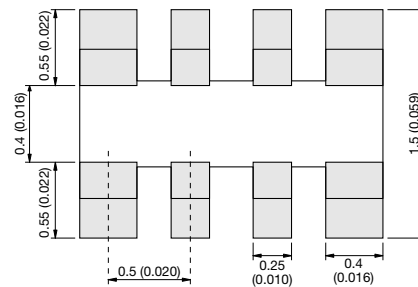

**CRC4A8E Series**

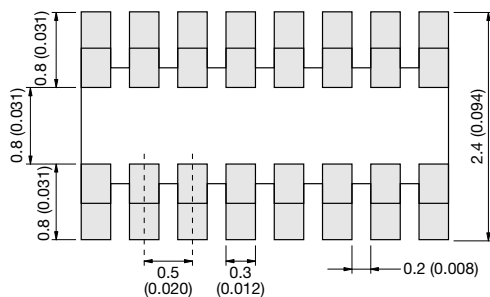

**CRB6A8E Series**

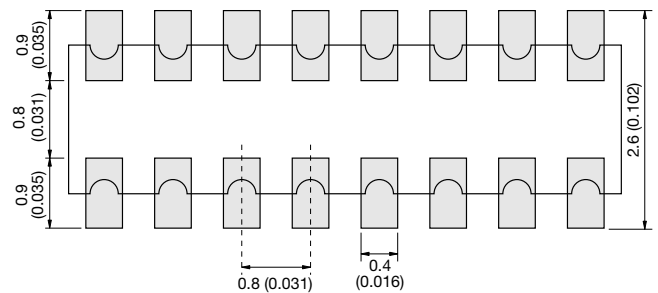

## SAMPLE KIT PART NUMBERS

Part Number	Description
<b>CRJ-E6-Kit</b>	Combination 0603, 0805, 1206, 5% parts 21 values per case size 100 pcs. per value (approx.)
<b>CR05-E12-Kit</b>	0402, 5% parts 63 values 100 pcs. per value
<b>CR10J-E12-Kit</b>	0603, 5% parts 63 values 100 pcs. per value (approx.)
<b>CR21J-E12-Kit</b>	0805, 5% parts 63 values 100 pcs. per value (approx.)
<b>CR32J-E12-Kit</b>	1206, 5% parts 63 values 100 pcs. per value (approx.)
<b>CR05F-E24-Kit</b>	0402, 1% parts 63 values 100 pcs. per value
<b>CR10F-E24-Kit</b>	0603, 1% parts 63 values 100 pcs. per value
<b>CR-ARRAY-E6-Kit</b>	Arrays, Various styles, CRA, CRB, CRC, RNA, 5% 13 values per style (approx.) 20 pcs. per value