

阅读申明

- 1.本站收集的数据手册和产品资料都来自互联网，版权归原作者所有。如读者和版权方有任何异议请及时告之，我们将妥善解决。
- 2.本站提供的中文数据手册是英文数据手册的中文翻译，其目的是协助用户阅读，该译文无法自动跟随原稿更新，同时也可能存在翻译上的不当。建议读者以英文原稿为参考以便获得更精准的信息。
- 3.本站提供的产品资料，来自厂商的技术支持或者使用者的心得体会等，其内容可能存在描述上的差异，建议读者做出适当判断。
- 4.如需与我们联系，请发邮件到marketing@iczoom.com，主题请标有“数据手册”字样。

Read Statement

1. The datasheets and other product information on the site are all from network reference or other public materials, and the copyright belongs to the original author and original published source. If readers and copyright owners have any objections, please contact us and we will deal with it in a timely manner.
2. The Chinese datasheets provided on the website is a Chinese translation of the English datasheets. Its purpose is for reader's learning exchange only and do not involve commercial purposes. The translation cannot be automatically updated with the original manuscript, and there may also be improper translations. Readers are advised to use the English manuscript as a reference for more accurate information.
3. All product information provided on the website refer to solutions from manufacturers' technical support or users the contents may have differences in description, and readers are advised to take the original article as the standard.
4. If you have any questions, please contact us at marketing@iczoom.com and mark the subject with "Datasheets" .

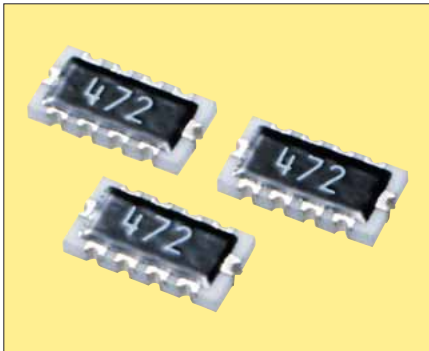

RoHS Conforming

Features

- Reduction in mounting costs & Process
- Save PCB space
- Eight resistors in one SMD package
- Reduction of inventory control costs

Applications

- Lap Top Computer
- Notebook Computer
- Printer
- Hard Disk Drive
- CD ROM
- Facsimile

How to Order

RNA4A 8E 103 J T
① ② ③ ④ ⑤

- ① Series
- ② Number of elements(8E : 8 elements)
- ③ Resistance code (3 digits)
- ④ Resistance tolerance(J : ±5%)
- ⑤ Packaging

T Plastic Taping, 4,000pcs/reel

* Taping Qty: 4000pcs/7 inch reel (4mm pitch)
Carrier Tape: plastic

Shape and Dimensions

(Unit : mm)

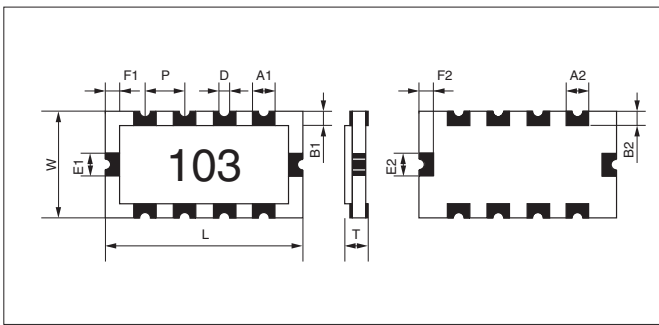

Code	L	W	T	A1	B1
Dimensions	4.0±0.15	2.1±0.15	0.6±0.1	0.5±0.1	0.25±0.15
Code	E1	F1	D	P	A2
Dimensions	0.5±0.1	0.3±0.15	0.3typ	0.8typ	0.4±0.1
Code	B2	E2	F2		
Dimensions	0.4±0.15	0.5±0.1	0.35±0.15		

Circuit Diagram

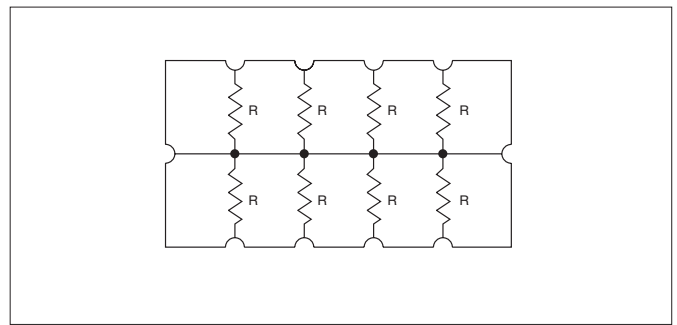

* nominal resistance value is all the same.

Specifications

Item	Rating
Rated power(70°C)	1/16W(0.0625W)/Element
Max working voltage*	25V
Max over-load voltage	50V
Resistance value	100Ω to 220KΩ
Tolerance	J:±5%
Number of elements	8E:8 Elements
Working temperature	-55 to +125°C

* Rated Voltage: √Rated power xResistance value, whichever is less.
* Standard Resistance Value: E-6 Series
* If resistance value under 100Ω is needed, please contact sales.

Tape & Reel

• Reel

(Unit : mm)

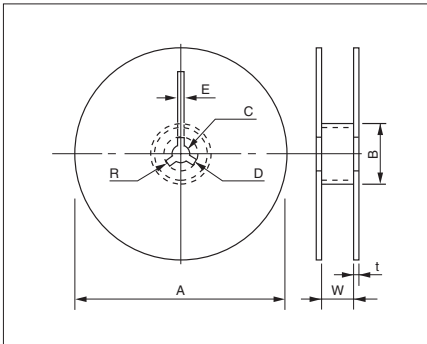

Code	A	B	C	D	E	W	t	R
Width: 8mm	$\phi 178 \pm 2.0$	$\phi 50 \text{min.}$	$\phi 13.0 \pm 0.5$	$\phi 21.0 \pm 0.8$	2.0 ± 0.5	10.0 ± 1.5	2.5MAX.	1.0
Width: 12mm						13.0 ± 1.5		

• Carrier Tape(8mm)

(Unit : mm)

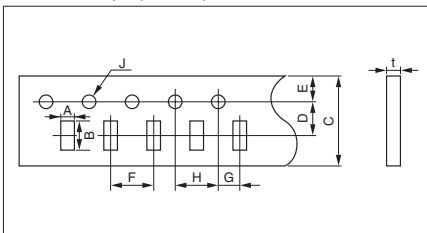

Dimension Code	A	B	C	D	E	F	G	H	J	t
TYPE 0404	1.2 ± 0.1	1.2 ± 0.1	8.0 ± 0.2	3.5 ± 0.05	1.75 ± 0.1	2.0 ± 0.1	2.0 ± 0.05	4.0 ± 0.1	$\phi 1.5 \begin{smallmatrix} +0.1 \\ -0.1 \end{smallmatrix}$	0.6max.
TYPE 0804	1.25 ± 0.2	2.25 ± 0.2								1.1max.
TYPE 0805	1.65 ± 0.2	2.4 ± 0.2				1.1max.				
TYPE 1206	2.0 ± 0.2	3.6 ± 0.2				1.1max.				
TYPE 1506	1.9 ± 0.2	4.1 ± 0.2				1.1max.				

• Carrier Tape(12mm)

(Unit : mm)

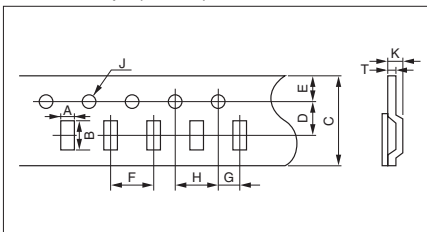

Dimension Code	A	B	C	D	E	F	G	H	J	T	K
TYPE 1020	2.9 ± 0.2	5.3 ± 0.2	12.0 ± 0.3	5.5 ± 0.05	1.75 ± 0.1	4.0 ± 0.1	2.0 ± 0.1	4.0 ± 0.1	$\phi 1.5 \begin{smallmatrix} +0.1 \\ -0.1 \end{smallmatrix}$	0.6max.	1.4max.
TYPE 1608	2.5 ± 0.2	4.4 ± 0.2									
TYPE 2512	3.5 ± 0.2	6.7 ± 0.2									
TYPE 2506	2.0 ± 0.2	6.9 ± 0.2									

• Taping Quantity per reel

(Unit : pcs)

TYPE	Series	Paper($\phi 178$ reel)
0404	CRC11A2E, ATC1A	10000(2mm pitch)
0804	CRB2A4E, CRC2A4E	10000(2mm pitch)
0805	LR21	5000(4mm pitch)
1206	LR32	5000(4mm pitch)
1506	CRC4A8E	5000(4mm pitch)
1020	LR50	4000(4mm pitch)
1608	RNA4A	4000(4mm pitch)
2512	LR63	4000(4mm pitch)
2506	CRB6A8E	4000(4mm pitch)

Recommended Land Patterns

Chip Type

(Unit : mm)

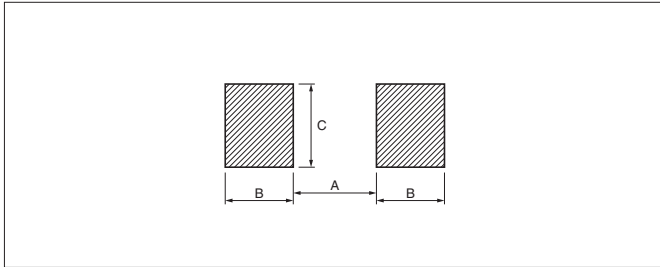

EIA Size	A	B	C
0805	1.0	0.8	1.2
1206	2.2	0.9	1.5
1020	1.4	1.0	5.0
2512	5.0	1.0	3.0

Array Type

(Unit : mm)

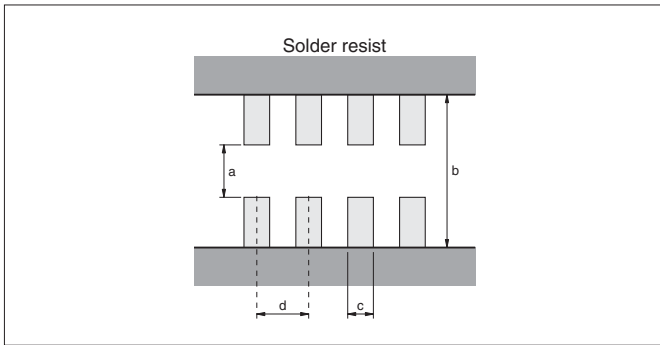

Series	a	b	c	d
CRB2A4E	0.4	1.5	0.25	0.5
CRC11A2E	0.5	1.5	0.4	0.65
CRC4A8E	0.8	2.4	0.3	0.5
CRB6A8E	0.7	2.3	0.4	0.8
ATC1A	0.5	1.5	0.4	0.65

(Unit : mm)

CRC2A4E Series

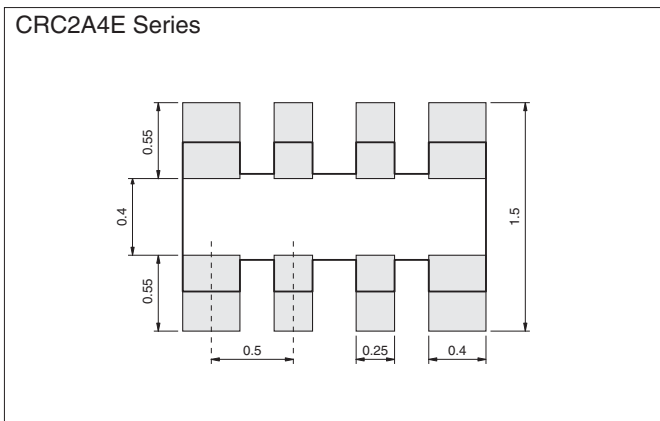

(Unit : mm)

RNA4A8E Series

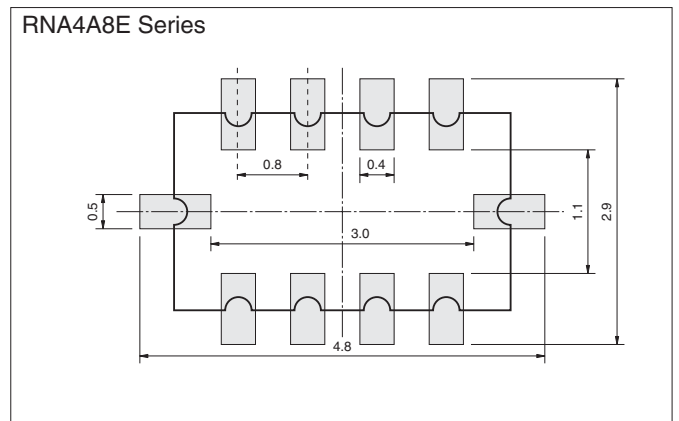

Circuit design

- 1) Once application and assembly environments have been checked, the resistors may be used in conformance with the catalog and the specifications.
- 2) Please consult the manufacturer in advance when the resistors is used in devices such as: devices which deal with human life, i.e. medical devices; devices which are highly public orientated; and devices which demand a high standard of liability.
- 3) Please use the resistors in conformance with the operating temperature provided in both the catalog and the specifications.
- 4) Please keep voltage under the rated voltage which is applied to the resistor.
- 5) Do not use the resistor in an environment where it might easily exceed the respective provisions concerning shock and vibration specified in the catalog and specifications.
- 6) Please do not use the resistor in the following environments.
 - ① State that water, oil, and solvent hang in resistor
 - ② State where poisonous gas (sulfur and chlorine, etc.) exists
 - ③ State that direct sunshine, radiation, and ultraviolet, etc. are irradiated
- 7) There is a thing that resistance changes according to the stuff of the resin when the coating with the resin is given.
Please use resin coating after confirming the characteristic.
- 8) There is a thing that resistance changes according to flux and cleaner.
Please use flux and cleaner after confirming the characteristic.
- 9) Please consult about a lead free products.

Storage

- 1) Keep storage place temperature +5 to +35°C, humidity 45 to 75% RH.
- 2) Please keep parts out of poisonous gas such as sulfur or chlorine in the air, and out of salty moisture. Or they may cause rust of terminal, and poor solderability. and, please consider the above-mentioned item after mounting your company.
- 3) Soldering iron

Temperature	soldering iron 300±5°C *
Time	3 sec. max. *

*Do not place the soldering iron on the chip. Soldering iron is 30W max.

Soldering method

1) Recommendable temperature profile

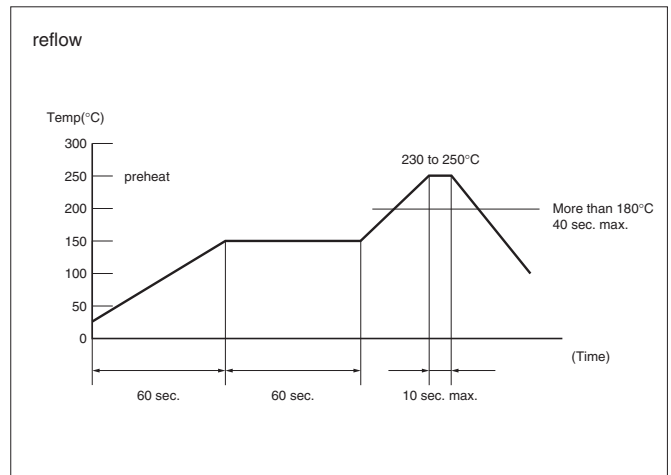

2) Recommendable temperature profile

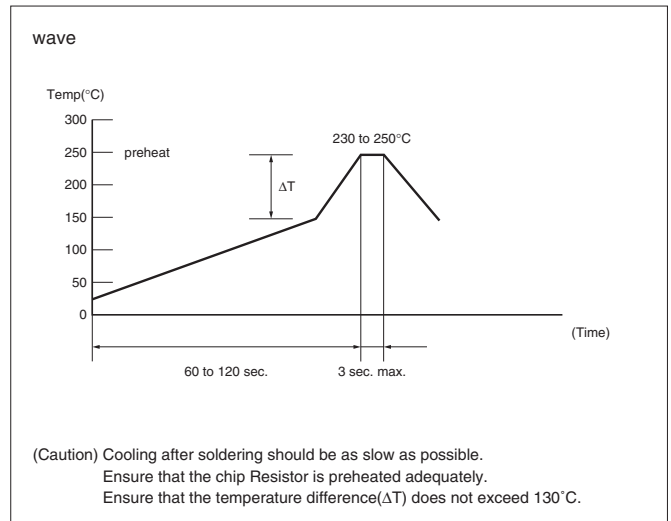

3) pb-free recommendable temperature profile

