

## 阅读申明

- 1.本站收集的数据手册和产品资料都来自互联网，版权归原作者所有。如读者和版权方有任何异议请及时告之，我们将妥善解决。
- 2.本站提供的中文数据手册是英文数据手册的中文翻译，其目的是协助用户阅读，该译文无法自动跟随原稿更新，同时也可能存在翻译上的不当。建议读者以英文原稿为参考以便获得更精准的信息。
- 3.本站提供的产品资料，来自厂商的技术支持或者使用者的心得体会等，其内容可能存在描述上的差异，建议读者做出适当判断。
- 4.如需与我们联系，请发邮件到marketing@iczoom.com，主题请标有“数据手册”字样。

## Read Statement

1. The datasheets and other product information on the site are all from network reference or other public materials, and the copyright belongs to the original author and original published source. If readers and copyright owners have any objections, please contact us and we will deal with it in a timely manner.
2. The Chinese datasheets provided on the website is a Chinese translation of the English datasheets. Its purpose is for reader's learning exchange only and do not involve commercial purposes. The translation cannot be automatically updated with the original manuscript, and there may also be improper translations. Readers are advised to use the English manuscript as a reference for more accurate information.
3. All product information provided on the website refer to solutions from manufacturers' technical support or users the contents may have differences in description, and readers are advised to take the original article as the standard.
4. If you have any questions, please contact us at marketing@iczoom.com and mark the subject with "Datasheets" .

# SPECIFICATION FOR APPROVAL

REF :

PAGE: 1

PROD. NAME	SMD BALUN TRANSFORMER	DWG NO.	BRN6036 Series
		ITEM NO.	

**I . MECHANICAL DIMENSIONS :**

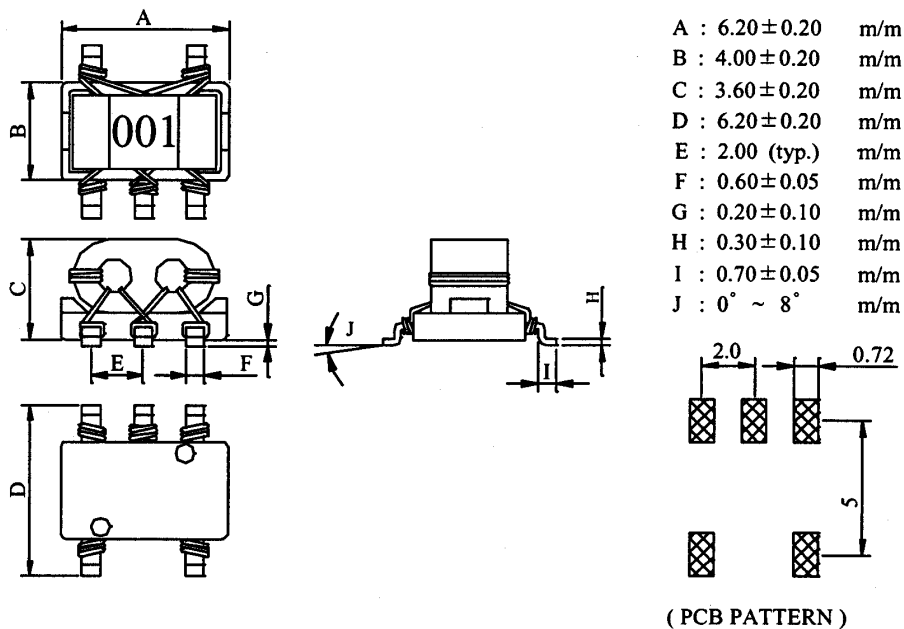

**II . MATERIALS :**

- a. CORE : FERRITE RID CORE
- b. BASE : PHENOLIC
- c. WIRE : ENAMELLED COPPER WIRE
- d. ADHESIVE : EPOXY RESIN
- e. TERMINAL : TINNED COPPER PLATE

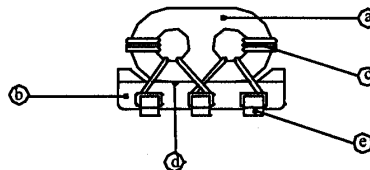

**III . FEATURES :**

- a. PAIRED WIRE COIL FOR HIGH STABILITY.
- b. BASE PIN TERMINAL TREATED, ALLOWING MOUNTING 'AS IS' ON A PCB.

**IV . APPLICATIONS :**

- a. DOUBLE BALANCE MIXERS, BROAD-BAND TRANSFORMERS, IMPEDANCE TRANSFORMERS, ETC.

AE-001A

**Bourns Inductive Solution**

# SPECIFICATION FOR APPROVAL

REF :

PAGE: 2

PROD. NAME	SMD BALUN TRANSFORMER	DWG NO.	BRN6036 Series
		ITEM NO.	

**V . ELECTRICAL CHARACTERISTICS :**

DWG NO.	WINDING TURNS	OPERATING FREQUENCY RANGE	INSERTION LOSS	PIN CONNECTION FIG.
BRN6036-0001S	2.0	30.0MHz- 850MHz	3.0dB max.	1
BRN6036-0002S	3.0	5.0MHz-1000MHz	3.0dB max.	1
BRN6036-0003S	4.0	9.0MHz-1700MHz	3.0dB max.	1
BRN6036-0004S	5.0	5.5MHz-1500MHz	3.0dB max.	1
BRN6036-0005S	1.0	20.0MHz- 400MHz	3.0dB max.	2
BRN6036-0006S	2.0	8.0MHz- 550MHz	3.0dB max.	2
BRN6036-0007S	3.0	3.5MHz-500MHz	3.0dB max.	2
BRN6036-0008S	4.0	2.0MHz-370MHz	3.0dB max.	2
BRN6036-0009S	1.0	100.0MHz- 500MHz	3.0dB max.	2
BRN6036-0010S	2.0	500.0MHz-850MHz	3.0dB max.	2
BRN6036-0011S	3.0	240.0MHz-500MHz	3.0dB max.	2
BRN6036-0012S	4.0	85.0MHz-380MHz	3.0dB max.	2
BRN6036-0013S	1.5	5.5MHz-850MHz	3.0dB max.	3
BRN6036-0014S	2.5	2.5MHz-2000MHz	3.0dB max.	3
BRN6036-0015S	3.5	1.2MHz-1700MHz	3.0dB max.	3
BRN6036-0016S	4.5	0.8MHz-1400MHz	3.0dB max.	3
BRN6036-0017S	5.5	0.6MHz-1300MHz	3.0dB max.	3
BRN6036-0018S	1.5	160.0MHz-2200MHz	3.0dB max.	4
BRN6036-0019S	2.5	55.0MHz-1700MHz	3.0dB max.	4
BRN6036-0020S	3.5	30.0MHz-1400MHz	3.0dB max.	4

**VI . SCHEMATIC DIAGRAM :**

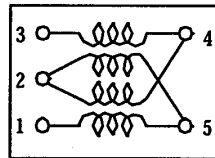

Double balanced  
Fig.1

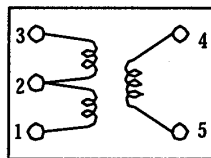

Transformer  
Fig.2

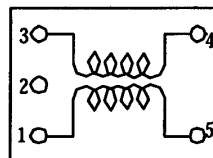

Transformer  
Fig.3

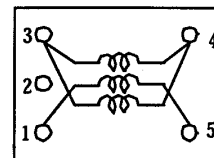

Transformer  
Fig.4

AE-001A

**Bourns Inductive Solution**

# SPECIFICATION FOR APPROVAL

REF :

PAGE: 3

<b>PROD. NAME</b>	<b>SMD BALUN TRANSFORMER</b>	<b>DWG NO.</b>	<b>BRN6036 Series</b>
		<b>ITEM NO.</b>	

**VII . PACKAGING INFORMATION :**

**(1) CONFIGURATION**

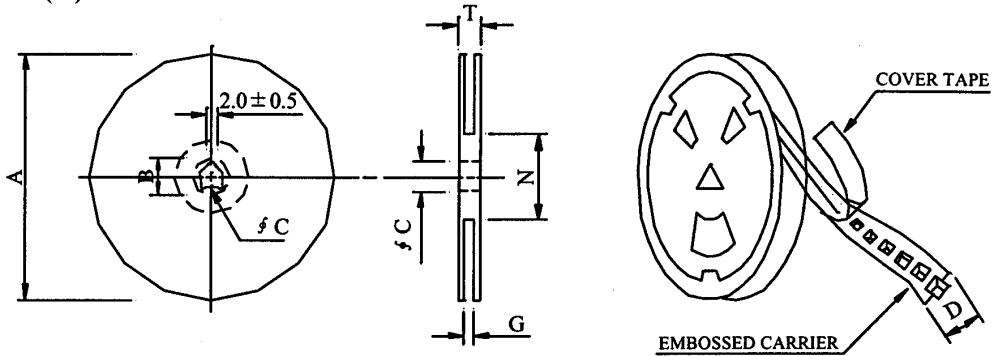

※CARRIER TAPE WIDTH : D

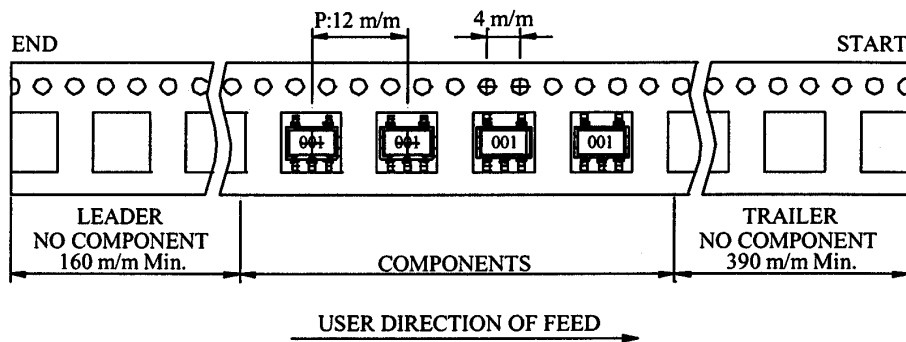

**(2) DIMENSIONS**

Unit:m/m

STYLE	A	B	C	D	G	N	T
07 - 16	178	21 ± 0.8	13	16	18 <sup>+0</sup>	50 <sup>-0</sup>	22.4
13 - 16	330	21 ± 0.8	13	16	18 <sup>+0</sup>	50 <sup>-0</sup>	22.4

**(3) QTY & G.W. PER PACKAGE**

SERIES	INNER : REEL			OUTER : CARTON		
	QTY (PCS)	G.W. (gw)	STYLE	QTY (PCS)	G.W. (Kg)	SIZE (cm)
BRN6036	300	96	07 - 16	12,000	4.45	39 x 38 x 21.5
BRN6036	1,200	384	13 - 16	9,600	3.68	40 x 40 x 24

AE-001A

**Bourns Inductive Solution**

# SPECIFICATION FOR APPROVAL

REF :

PAGE: 4

<b>PROD. NAME</b>	<b>SMD BALUN TRANSFORMER</b>	<b>DWG NO.</b>	BRN6036 Series
		<b>ITEM NO.</b>	

**X . INSERTION LOSS TEST CURVE :**

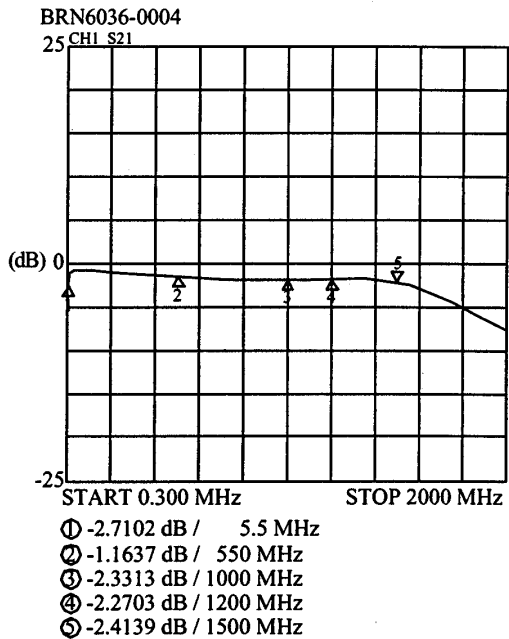
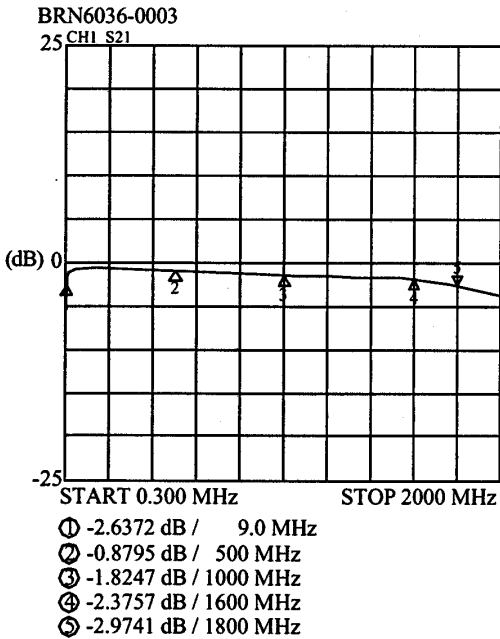
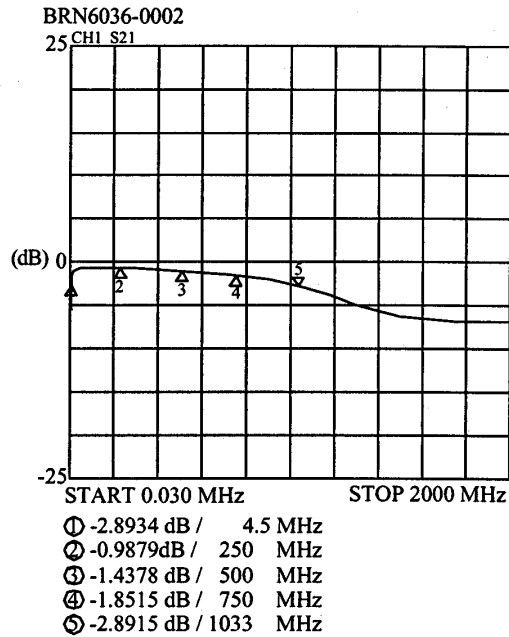
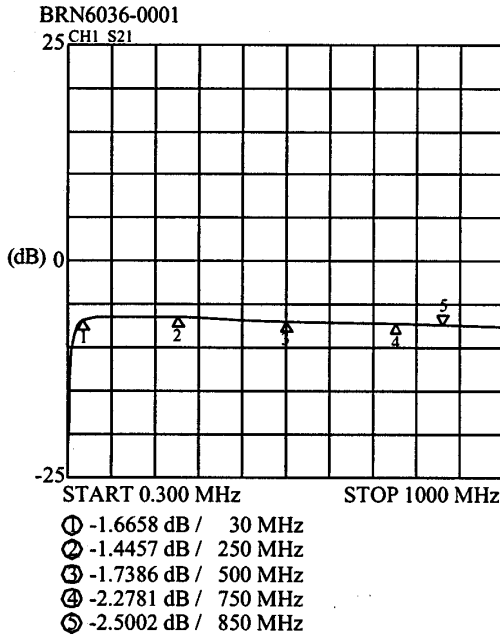

AE-001A

# SPECIFICATION FOR APPROVAL

REF :

PAGE: 5

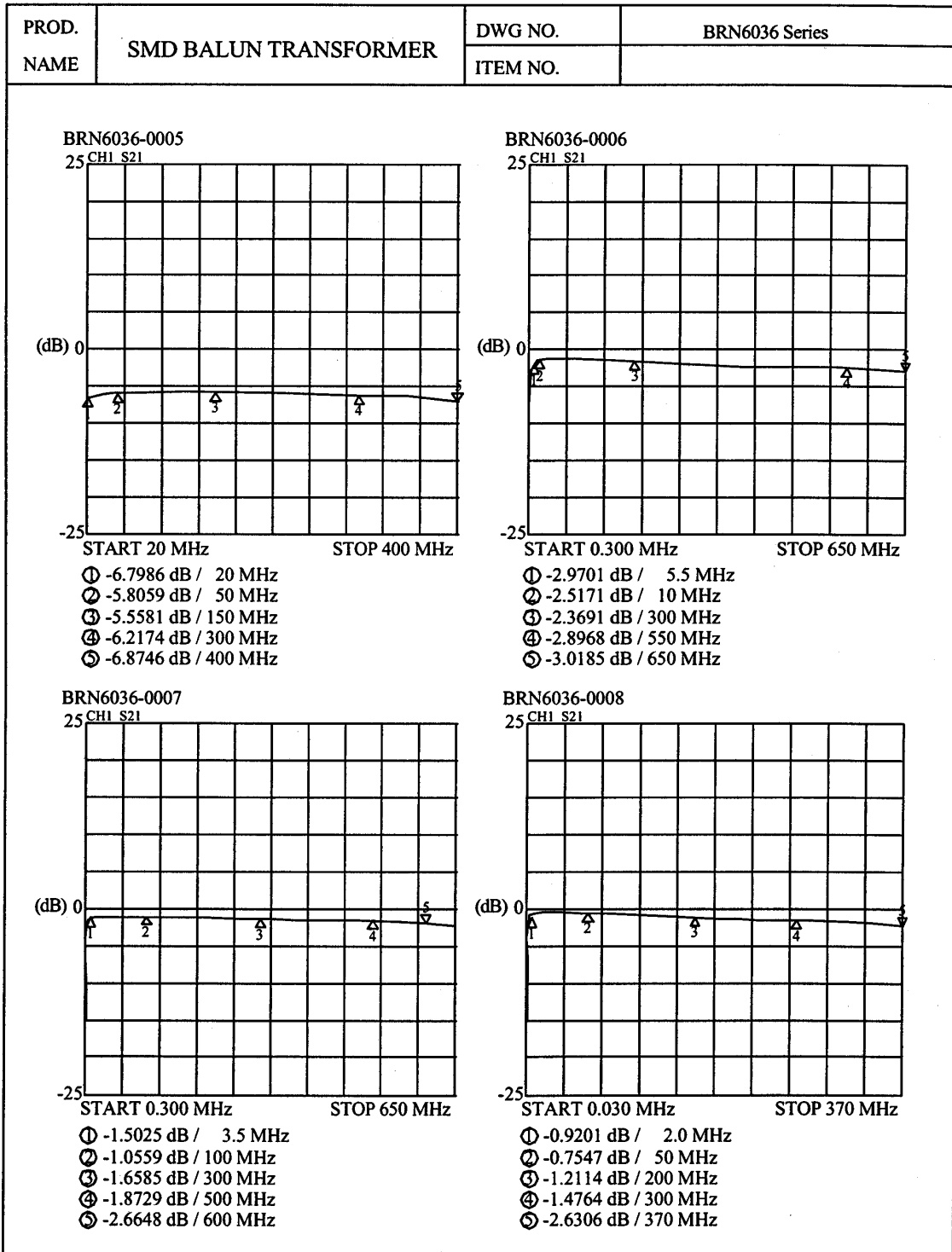

AE-001A

**Bourns Inductive Solution**

# SPECIFICATION FOR APPROVAL

REF :

PAGE: 6

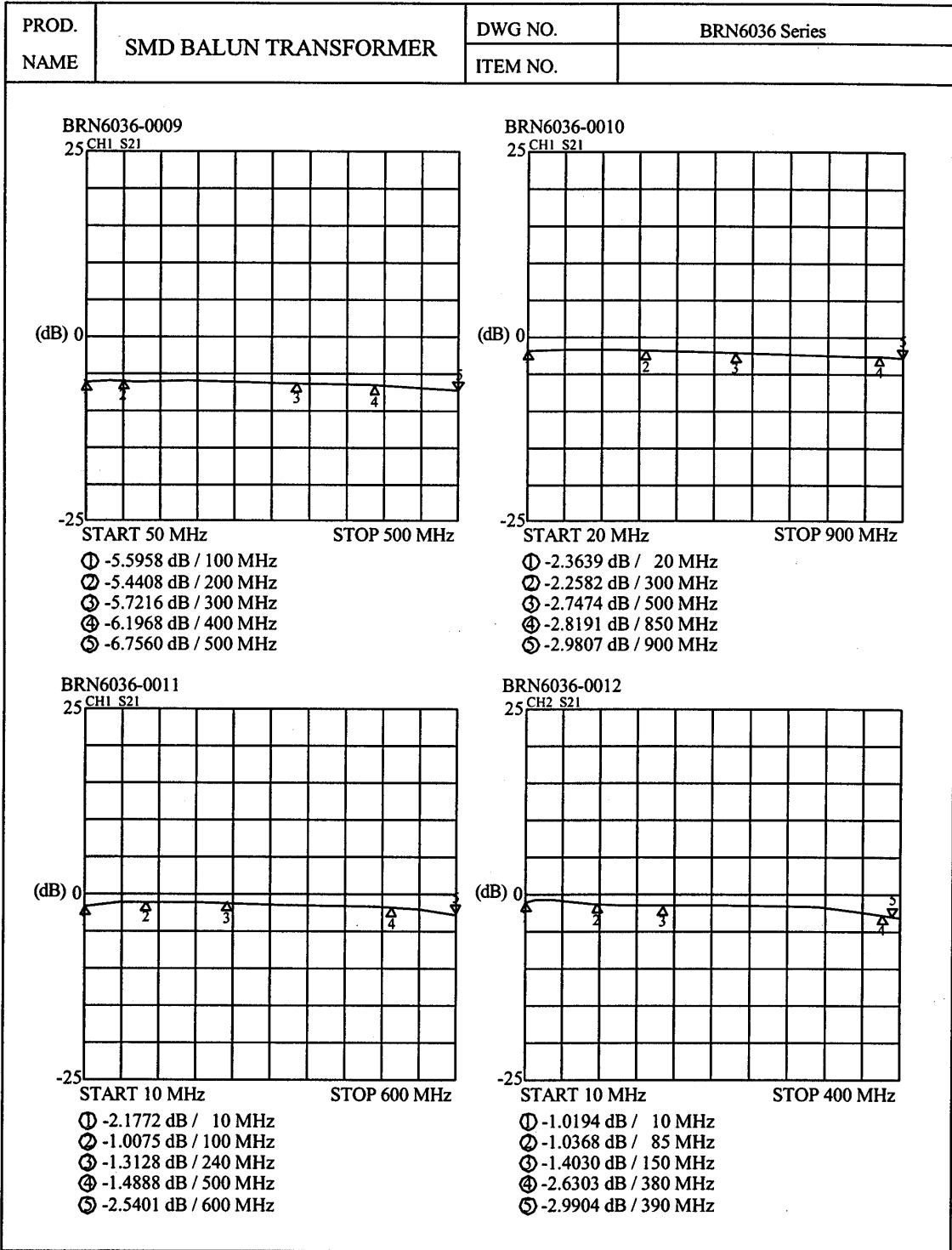

AE-001A

**Bourns Inductive Solution**

# SPECIFICATION FOR APPROVAL

REF :

PAGE: 7

PROD. NAME	SMD BALUN TRANSFORMER	DWG NO.	BRN6036 Series
		ITEM NO.	
<div style="display: flex; justify-content: space-around;"> <div style="width: 48%;"> <p><b>BRN6036-0013</b> 25 CH1 S21</p> <p>(dB) 0 -25</p> <p>START 0.300 MHz STOP 2500 MHz</p> <ul style="list-style-type: none"> <li>① -2.4058 dB / 10 MHz</li> <li>② -2.5636 dB / 1000 MHz</li> <li>③ -2.4434 dB / 850 MHz</li> <li>④ -2.5226 dB / 1200 MHz</li> <li>⑤ -1.3914 dB / 2000 MHz</li> </ul> </div> <div style="width: 48%;"> <p><b>BRN6036-0014</b> 25 CH1 S21</p> <p>(dB) 0 -25</p> <p>START 0.300 MHz STOP 2500 MHz</p> <ul style="list-style-type: none"> <li>① -2.4797 dB / 6.0 MHz</li> <li>② -2.8760 dB / 1000 MHz</li> <li>③ -2.8448 dB / 850 MHz</li> <li>④ -2.6107 dB / 1200 MHz</li> <li>⑤ -2.8353 dB / 2000 MHz</li> </ul> </div> </div>			
<div style="display: flex; justify-content: space-around;"> <div style="width: 48%;"> <p><b>BRN6036-0015</b> 25 CH1 S21</p> <p>(dB) 0 -25</p> <p>START 0.300 MHz STOP 2500 MHz</p> <ul style="list-style-type: none"> <li>① -1.5440 dB / 6.0 MHz</li> <li>② -2.5877 dB / 600 MHz</li> <li>③ -2.8402 dB / 850 MHz</li> <li>④ -1.8911 dB / 1200 MHz</li> <li>⑤ -2.8265 dB / 1700 MHz</li> </ul> </div> <div style="width: 48%;"> <p><b>BRN6036-0016</b> 25 CH2 S21</p> <p>(dB) 0 -25</p> <p>START 0.300 MHz STOP 2500 MHz</p> <ul style="list-style-type: none"> <li>① -2.6800 dB / 5.0 MHz</li> <li>② -2.3717 dB / 600 MHz</li> <li>③ -1.7034 dB / 1000 MHz</li> <li>④ -1.4836 dB / 1200 MHz</li> <li>⑤ -2.5552 dB / 1400 MHz</li> </ul> </div> </div>			

AE-001A

**Bourns Inductive Solution**



# SPECIFICATION FOR APPROVAL

REF :

PAGE: 8

PROD. NAME SMD BALUN TRANSFORMER	DWG NO. BRN6036 Series	
	ITEM NO.	

<p>BRN6036-0017 25 CH1 S21</p> <p>(dB) 0 -25</p> <p>START 0.300 MHz STOP 2500 MHz</p> <ul style="list-style-type: none"> <li>① -1.9838 dB / 5.0 MHz</li> <li>② -1.7345 dB / 500 MHz</li> <li>③ -1.1251 dB / 850 MHz</li> <li>④ -2.1274 dB / 1300 MHz</li> <li>⑤ -3.0150 dB / 1400 MHz</li> </ul>	<p>BRN6036-0018 25 CH1 S21</p> <p>(dB) 0 -25</p> <p>START 0.300 MHz STOP 2500 MHz</p> <ul style="list-style-type: none"> <li>① -2.6582 dB / 160 MHz</li> <li>② -2.0335 dB / 500 MHz</li> <li>③ -2.8600 dB / 1000 MHz</li> <li>④ -1.7604 dB / 2000 MHz</li> <li>⑤ -2.7750 dB / 2400 MHz</li> </ul>
<p>BRN6036-0019 25 CH1 S21</p> <p>(dB) 0 -25</p> <p>START 0.300 MHz STOP 2500 MHz</p> <ul style="list-style-type: none"> <li>① -2.8956 dB / 60 MHz</li> <li>② -1.9037 dB / 500 MHz</li> <li>③ -2.7778 dB / 850 MHz</li> <li>④ -1.4123 dB / 1700 MHz</li> <li>⑤ -2.6534 dB / 2250 MHz</li> </ul>	<p>BRN6036-0020 25 CH2 S21</p> <p>(dB) 0 -25</p> <p>START 0.300 MHz STOP 2500 MHz</p> <ul style="list-style-type: none"> <li>① -2.8621 dB / 30 MHz</li> <li>② -1.1315 dB / 500 MHz</li> <li>③ -0.9943 dB / 1000 MHz</li> <li>④ -1.4555 dB / 1400 MHz</li> <li>⑤ -2.8334 dB / 1550 MHz</li> </ul>

AE-001A

**Bourns Inductive Solution**