

## 阅读申明

- 1.本站收集的数据手册和产品资料都来自互联网，版权归原作者所有。如读者和版权方有任何异议请及时告之，我们将妥善解决。
- 2.本站提供的中文数据手册是英文数据手册的中文翻译，其目的是协助用户阅读，该译文无法自动跟随原稿更新，同时也可能存在翻译上的不当。建议读者以英文原稿为参考以便获得更精准的信息。
- 3.本站提供的产品资料，来自厂商的技术支持或者使用者的心得体会等，其内容可能存在描述上的差异，建议读者做出适当判断。
- 4.如需与我们联系，请发邮件到marketing@iczoom.com，主题请标有“数据手册”字样。

## Read Statement

1. The datasheets and other product information on the site are all from network reference or other public materials, and the copyright belongs to the original author and original published source. If readers and copyright owners have any objections, please contact us and we will deal with it in a timely manner.
2. The Chinese datasheets provided on the website is a Chinese translation of the English datasheets. Its purpose is for reader's learning exchange only and do not involve commercial purposes. The translation cannot be automatically updated with the original manuscript, and there may also be improper translations. Readers are advised to use the English manuscript as a reference for more accurate information.
3. All product information provided on the website refer to solutions from manufacturers' technical support or users the contents may have differences in description, and readers are advised to take the original article as the standard.
4. If you have any questions, please contact us at marketing@iczoom.com and mark the subject with "Datasheets" .



## Product Description

The SGA-4163 is a high performance SiGe HBT MMIC Amplifier. A Darlington configuration featuring 1 micron emitters provides high  $F_T$  and excellent thermal performance. The heterojunction increases breakdown voltage and minimizes leakage current between junctions. Cancellation of emitter junction non-linearities results in higher suppression of intermodulation products. Only 2 DC-blocking capacitors, a bias resistor and an optional RF choke are required for operation.

The matte tin finish on Sirenza's lead-free package utilizes a post annealing process to mitigate tin whisker formation and is RoHS compliant per EU Directive 2002/95. This package is also manufactured with green molding compounds that contain no antimony trioxide nor halogenated fire retardants.

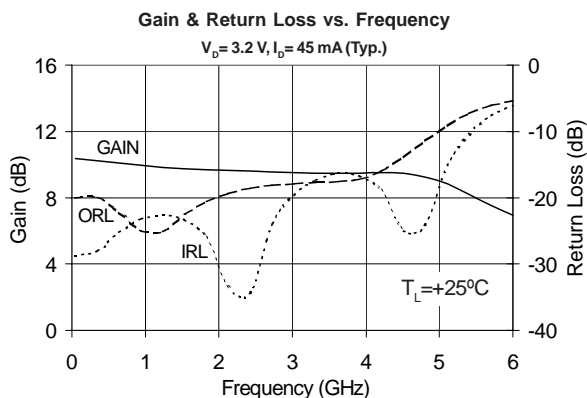

## SGA-4163

**SGA-4163Z** RoHS Compliant & Green Package

**DC-5000 MHz, Cascadable  
SiGe HBT MMIC Amplifier**



### Product Features

- Now available in Lead Free, RoHS Compliant, & Green Packaging
- Broadband Operation: DC-5000 MHz
- Cascadable 50 Ohm
- Operates From Single Supply
- Low Thermal Resistance Package

### Applications

- PA Driver Amplifier
- Cellular, PCS, GSM, UMTS
- IF Amplifier
- Wireless Data, Satellite

Symbol	Parameter	Units	Frequency	Min.	Typ.	Max.
G	Small Signal Gain	dB	850 MHz 1950 MHz 2400 MHz	9.5	10.5 9.7 9.6	11.5
$P_{1dB}$	Output Power at 1dB Compression	dBm	850 MHz 1950 MHz		13.0 12.1	
$OIP_3$	Output Third Order Intercept Point	dBm	850 MHz 1950 MHz		29.7 25.4	
Bandwidth	Determined by Return Loss (>10dB)	MHz			5000	
IRL	Input Return Loss	dB	1950 MHz		28.0	
ORL	Output Return Loss	dB	1950 MHz		20.1	
NF	Noise Figure	dB	1950 MHz		5.0	
$V_D$	Device Operating Voltage	V		2.9	3.2	3.5
$I_D$	Device Operating Current	mA		41	45	49
$R_{TH}, j-l$	Thermal Resistance (junction to lead)	$^{\circ}\text{C}/\text{W}$			255	

**Test Conditions:**  $V_S = 8\text{ V}$   $I_D = 45\text{ mA Typ.}$   $OIP_3$  Tone Spacing = 1 MHz,  $P_{out}$  per tone = -5 dBm  
 $R_{BIAS} = 110\text{ Ohms}$   $T_L = 25^{\circ}\text{C}$   $Z_S = Z_L = 50\text{ Ohms}$

The information provided herein is believed to be reliable at press time. Sirenza Microdevices assumes no responsibility for inaccuracies or omissions. Sirenza Microdevices assumes no responsibility for the use of this information, and all such information shall be entirely at the user's own risk. Prices and specifications are subject to change without notice. No patent rights or licenses to any of the circuits described herein are implied or granted to any third party. Sirenza Microdevices does not authorize or warrant any Sirenza Microdevices product for use in life-support devices and/or systems. Copyright 2001 Sirenza Microdevices, Inc.. All worldwide rights reserved.

**Typical RF Performance at Key Operating Frequencies**

Symbol	Parameter	Unit	Frequency (MHz)					
			100	500	850	1950	2400	3500
G	Small Signal Gain	dB	10.3	10.2	10.5	9.7	9.6	9.4
OIP <sub>3</sub>	Output Third Order Intercept Point	dBm		30.2	29.7	25.4	23.0	
P <sub>1dB</sub>	Output Power at 1dB Compression	dBm		12.9	13.0	12.1	11.1	
IRL	Input Return Loss	dB	29.1	26.7	23.7	28.0	36.7	16.6
ORL	Output Return Loss	dB	19.7	20.8	24.3	20.1	18.7	17.6
S <sub>12</sub>	Reverse Isolation	dB	15.5	16.0	16.3	17.2	17.6	18.4
NF	Noise Figure	dB		4.6	4.8	5.0	5.3	

**Test Conditions:** V<sub>S</sub> = 8 V, I<sub>D</sub> = 45 mA Typ., OIP<sub>3</sub> Tone Spacing = 1 MHz, Pout per tone = -5 dBm  
R<sub>BIAS</sub> = 110 Ohms, T<sub>L</sub> = 25°C, Z<sub>S</sub> = Z<sub>L</sub> = 50 Ohms

**Noise Figure vs. Frequency**  
V<sub>D</sub> = 3.2 V, I<sub>D</sub> = 45 mA (Typ.)

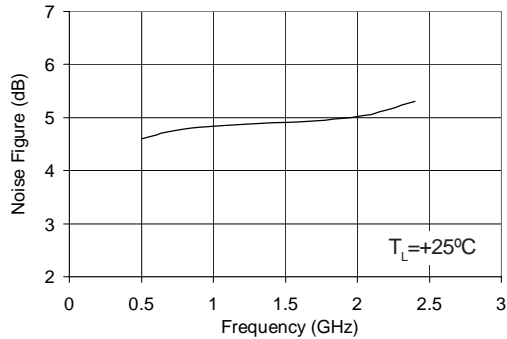

**Absolute Maximum Ratings**

Parameter	Absolute Limit
Max. Device Current (I <sub>D</sub> )	90 mA
Max. Device Voltage (V <sub>D</sub> )	5 V
Max. RF Input Power	+18 dBm
Max. Junction Temp. (T <sub>J</sub> )	+150°C
Operating Temp. Range (T <sub>L</sub> )	-40°C to +85°C
Max. Storage Temp.	+150°C

Operation of this device beyond any one of these limits may cause permanent damage. For reliable continuous operation, the device voltage and current must not exceed the maximum operating values specified in the table on page one.  
Bias conditions should also satisfy the following expression:  
 $I_D V_D < (T_J - T_L) / R_{TH} \text{ J}^{-1}$

**OIP<sub>3</sub> vs. Frequency**  
V<sub>D</sub> = 3.2 V, I<sub>D</sub> = 45 mA (Typ.)

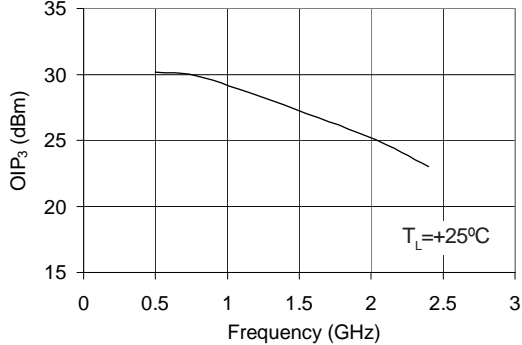

**P<sub>1dB</sub> vs. Frequency**  
V<sub>D</sub> = 3.2 V, I<sub>D</sub> = 45 mA (Typ.)

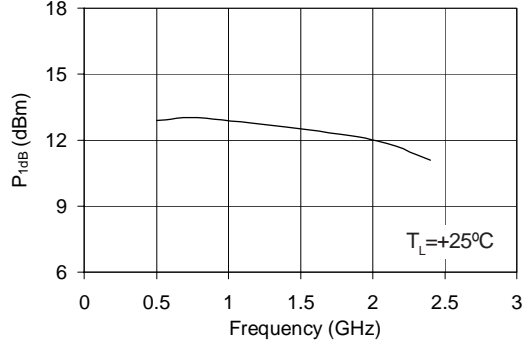

**Typical RF Performance Over Temperature ( Bias:  $V_D = 3.2$  V,  $I_D = 45$  mA (Typ.) )**

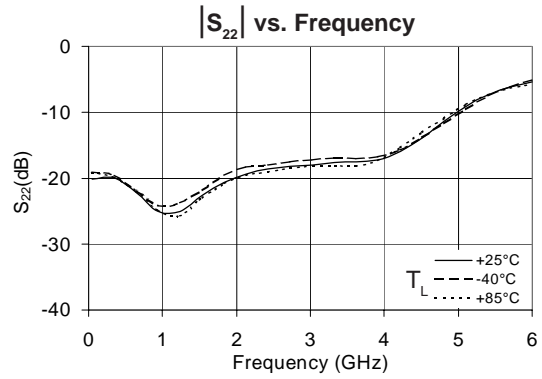
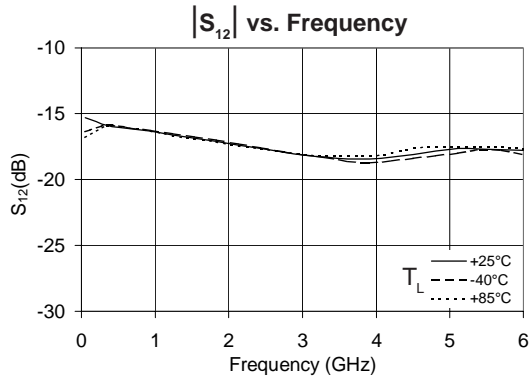
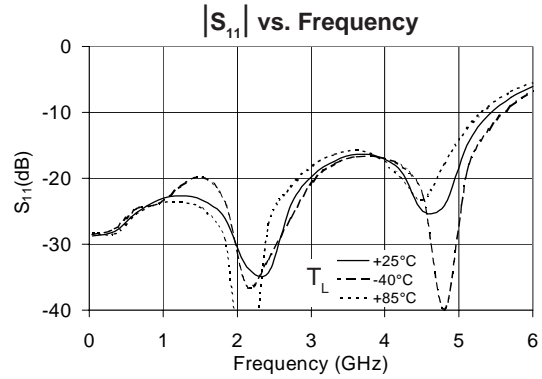
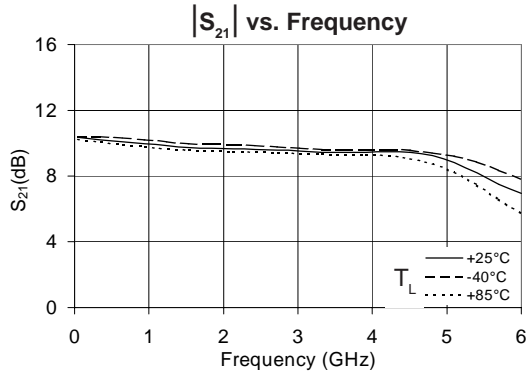

NOTE: Full S-parameter data available at [www.sirenza.com](http://www.sirenza.com)

**Basic Application Circuit**

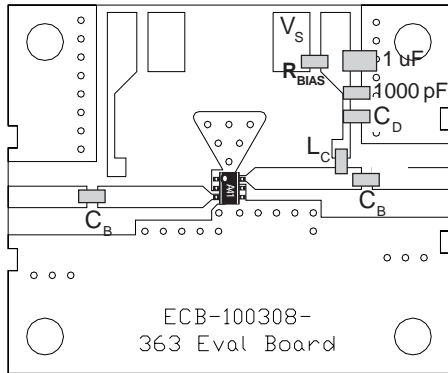
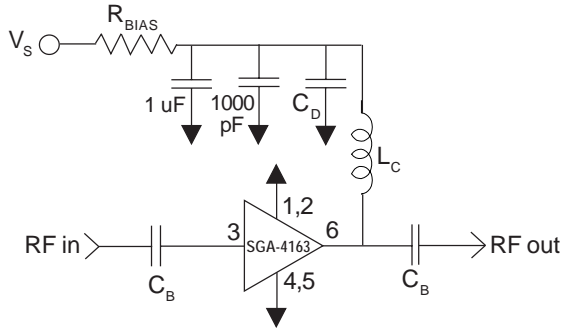

**Part Identification Marking**

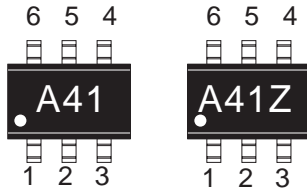

**Caution: ESD sensitive**  
Appropriate precautions in handling, packaging and testing devices must be observed.

**Application Circuit Element Values**

Reference Designator	Frequency (Mhz)				
	500	850	1950	2400	3500
C <sub>B</sub>	220 pF	100 pF	68 pF	56 pF	39 pF
C <sub>D</sub>	100 pF	68 pF	22 pF	22 pF	15 pF
L <sub>C</sub>	68 nH	33 nH	22 nH	18 nH	15 nH

**Recommended Bias Resistor Values for I<sub>D</sub>=45mA**  
 $R_{BIAS} = (V_S - V_D) / I_D$

Supply Voltage (V <sub>S</sub> )	6 V	8 V	10 V	12 V
R <sub>BIAS</sub>	62 Ω	110 Ω	150 Ω	200 Ω

Note: R<sub>BIAS</sub> provides DC bias stability over temperature.

**Mounting Instructions**

1. Use a large ground pad area near device pins 1, 2, 4, and 5 with many plated through-holes as shown.
3. We recommend 1 or 2 ounce copper. Measurements for this data sheet were made on a 31 mil thick FR-4 board with 1 ounce copper on both sides.

Pin #	Function	Description
3	RF IN	RF input pin. This pin requires the use of an external DC blocking capacitor chosen for the frequency of operation.
1, 2, 4, 5	GND	Connection to ground. For optimum RF performance, use via holes as close to ground leads as possible to reduce lead inductance.
6	RF OUT/BIAS	RF output and bias pin. DC voltage is present on this pin, therefore a DC blocking capacitor is necessary for proper operation.

**Part Number Ordering Information**

Part Number	Reel Size	Devices/Reel
<b>SGA-4163</b>	<b>7"</b>	<b>3000</b>
<b>SGA-4163Z</b>	<b>7"</b>	<b>3000</b>

**SOT-363 PCB Pad Layout**

Dimensions in inches [millimeters]

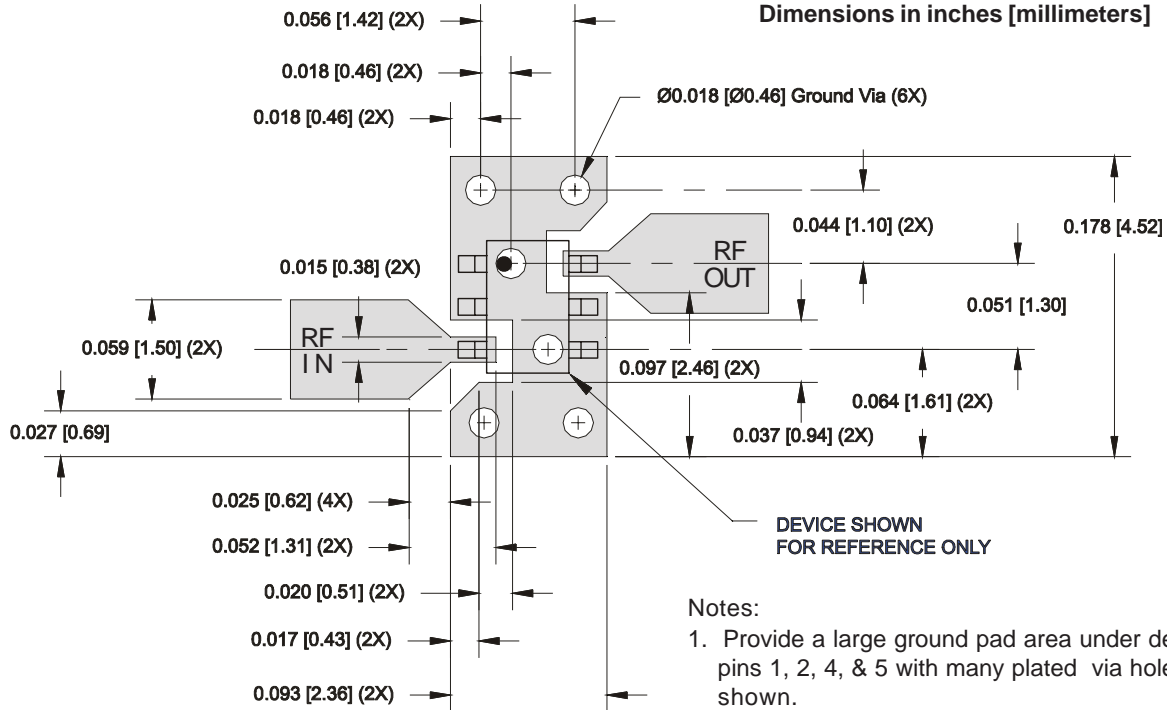

Notes:

1. Provide a large ground pad area under device pins 1, 2, 4, & 5 with many plated via holes as shown.
2. Dimensions given for 50 Ohm RF I/O lines are for 31 mil thick Getek. Scale accordingly for different board thicknesses and dielectric constants.
3. We recommend 1 or 2 ounce copper. Measurements for this data sheet were made on a 31 mil thick Getek with 1 ounce copper on both sides.

**SOT-363 Nominal Package Dimensions**

Dimensions in inches [millimeters]

A link to the SOT-363 package outline drawing with full dimensions and tolerances may be found on the product web page at [www.sirenza.com](http://www.sirenza.com).

