

阅读申明

- 1.本站收集的数据手册和产品资料都来自互联网，版权归原作者所有。如读者和版权方有任何异议请及时告之，我们将妥善解决。
- 2.本站提供的中文数据手册是英文数据手册的中文翻译，其目的是协助用户阅读，该译文无法自动跟随原稿更新，同时也可能存在翻译上的不当。建议读者以英文原稿为参考以便获得更精准的信息。
- 3.本站提供的产品资料，来自厂商的技术支持或者使用者的心得体会等，其内容可能存在描述上的差异，建议读者做出适当判断。
- 4.如需与我们联系，请发邮件到marketing@iczoom.com，主题请标有“数据手册”字样。

Read Statement

1. The datasheets and other product information on the site are all from network reference or other public materials, and the copyright belongs to the original author and original published source. If readers and copyright owners have any objections, please contact us and we will deal with it in a timely manner.
2. The Chinese datasheets provided on the website is a Chinese translation of the English datasheets. Its purpose is for reader's learning exchange only and do not involve commercial purposes. The translation cannot be automatically updated with the original manuscript, and there may also be improper translations. Readers are advised to use the English manuscript as a reference for more accurate information.
3. All product information provided on the website refer to solutions from manufacturers' technical support or users the contents may have differences in description, and readers are advised to take the original article as the standard.
4. If you have any questions, please contact us at marketing@iczoom.com and mark the subject with "Datasheets" .

RoHS Compliant & Pb-Free Product
Package Style: AIN



Features

- 4W Output Power
- High Linearity
- 1500MHz to 2200MHz Operation
- 5V to 8V Supply with Adjustable Bias

Applications

- GaAs HBT Linear Amplifier
- Power Amplifier Stage for Commercial Wireless Infrastructure (DCS, PCS, UMTS)

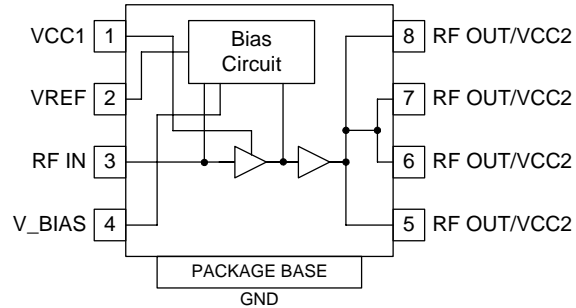

Functional Block Diagram

Product Description

The RF3806 is a GaAs power amplifier, specifically designed for linear applications. Using a highly reliable GaAs HBT fabrication process, this high-performance two-stage amplifier achieves high output power over a broad frequency range. An evaluation board is available to address UMTS2100 applications.

Ordering Information

RF3806 GaAs HBT Pre-Driver Amplifier
RF3806PCK-415 Fully Assembled Evaluation Board - UMTS2100

Optimum Technology Matching® Applied

- | | | | |
|--|--------------------------------------|-------------------------------------|-----------------------------------|
| <input checked="" type="checkbox"/> GaAs HBT | <input type="checkbox"/> SiGe BiCMOS | <input type="checkbox"/> GaAs pHEMT | <input type="checkbox"/> GaN HEMT |
| <input type="checkbox"/> GaAs MESFET | <input type="checkbox"/> Si BiCMOS | <input type="checkbox"/> Si CMOS | |
| <input type="checkbox"/> InGaP HBT | <input type="checkbox"/> SiGe HBT | <input type="checkbox"/> Si BJT | |

RF MICRO DEVICES®, RFMD®, Optimum Technology Matching®, Enabling Wireless Connectivity™, PowerStar®, POLARIS™ TOTAL RADIO™ and UltimateBlue™ are trademarks of RFMD, LLC. BLUETOOTH is a trademark owned by Bluetooth SIG, Inc., U.S.A. and licensed for use by RFMD. All other trade names, trademarks and registered trademarks are the property of their respective owners. ©2006, RF Micro Devices, Inc.

Absolute Maximum Ratings

Parameter	Rating	Unit
Supply Voltage (V_{CC} and V_{BIAS})	8	V
DC Supply Current	2870	mA
Maximum Input Power	23	dBm
Operating Ambient Temperature	+85	°C
Storage Temperature	+125	°C



Caution! ESD sensitive device.

Exceeding any one or a combination of the Absolute Maximum Rating conditions may cause permanent damage to the device. Extended application of Absolute Maximum Rating conditions to the device may reduce device reliability. Specified typical performance or functional operation of the device under Absolute Maximum Rating conditions is not implied.

RoHS status based on EU Directive 2002/95/EC (at time of this document revision).

The information in this publication is believed to be accurate and reliable. However, no responsibility is assumed by RF Micro Devices, Inc. ("RFMD") for its use, nor for any infringement of patents, or other rights of third parties, resulting from its use. No license is granted by implication or otherwise under any patent or patent rights of RFMD. RFMD reserves the right to change component circuitry, recommended application circuitry and specifications at any time without prior notice.

Parameter	Specification			Unit	Condition
	Min.	Typ.	Max.		
Overall - UMTS2100					
$V_{CC}=8V$					
Frequency	2110		2170	MHz	$I_{REF}=60\text{ mA}$, $V_{CC}=V_{BIAS}=V_{REF}=8V$, Temp = +25 °C
P1dB	35	36	37	dBm	Performance with impedance match as per UMTS evaluation board
Gain (S21)	17	18	19	dB	
Input Return Loss (S11)		-12		dB	
Output Return Loss (S22)		-6		dB	
Two-Tone Specification					
OIP3		47		dBm	23 dBm/tone
Power Supply					
Power Supply Voltage		8		V	
Supply Current ($I_{CC}+I_{BIAS}$)	660	730	800	mA	I_{CCQ}
Power Down Current			50	μA	$V_{REF}=0V$, $V_{CC}=V_{BIAS}=8V$
$V_{CC}=6V$					
Frequency	2110		2170	MHz	$I_{REF}=60\text{ mA}$, $V_{CC}=V_{BIAS}=V_{REF}=6V$, Temp = +25 °C
P1dB		34.5		dBm	Performance with impedance match as per UMTS evaluation board
Gain (S21)		18		dB	
Two-Tone Specification					
OIP3		46		dBm	21 dBm/tone
Power Supply					
Power Supply Voltage		6		V	
Supply Current ($I_{CC}+I_{BIAS}$)		718		mA	I_{CCQ}
$V_{CC}=5V$					
Frequency	2110		2170	MHz	$I_{REF}=60\text{ mA}$, $V_{CC}=V_{BIAS}=V_{REF}=5V$, Temp = +25 °C
P1dB		33		dBm	Performance with impedance match as per UMTS evaluation board
Gain (S21)		18.5		dB	
Two-Tone Specification					
OIP3		45		dBm	20 dBm/tone

Parameter	Specification			Unit	Condition
	Min.	Typ.	Max.		
Power Supply					
Power Supply Voltage		5		V	
Supply Current ($I_{CC} + I_{BIAS}$)		707		mA	I_{CCQ}
Overall - PCS1900					
$V_{CC} = 8V$					
Frequency	1930		1990	MHz	$I_{REF} = 60\text{mA}$, $V_{CC} = V_{BIAS} = V_{REF} = 8V$, Temp = +25 °C
P1dB		37		dBm	Performance with impedance match as per DCS/PHS/PCS low power linear application schematic
Gain (S21)		18		dB	
Input Return Loss (S11)		-14		dB	
Output Return Loss (S22)		-8		dB	
Two-Tone Specification					
OIP3		52		dBm	23 dBm/tone
Power Supply					
Power Supply Voltage		8		V	
Supply Current ($I_{CC} + I_{BIAS}$)	660	730	800	mA	I_{CCQ}
Power Down Current			50	μA	$V_{REF} = 0V$, $V_{CC} = V_{BIAS} = 8V$
$V_{CC} = 6V$					
Frequency	1930		1990	MHz	$I_{REF} = 60\text{mA}$, $V_{CC} = V_{BIAS} = V_{REF} = 6V$, Temp = +25 °C
P1dB		35		dBm	Performance with impedance match as per DCS/PHS/PCS low power linear application schematic
Gain (S21)		18		dB	
Two-Tone Specification					
OIP3		49		dBm	21 dBm/tone
Power Supply					
Power Supply Voltage		6		V	
Supply Current ($I_{CC} + I_{BIAS}$)		713		mA	I_{CCQ}
$V_{CC} = 5V$					
Frequency	1930		1990	MHz	$I_{REF} = 60\text{mA}$, $V_{CC} = V_{BIAS} = V_{REF} = 5V$, Temp = +25 °C
P1dB		33.5		dBm	Performance with impedance match as per DCS/PHS/PCS low power linear application schematic
Gain (S21)		18.5		dB	
Two-Tone Specification					
OIP3		49		dBm	20 dBm/tone
Power Supply					
Power Supply Voltage		5		V	
Supply Current ($I_{CC} + I_{BIAS}$)		707		mA	I_{CCQ}

Pin	Function	Description	Interface Schematic
1	VCC1	For input stage.	
2	VREF	Control for active bias. See "Theory of Operation" section.	
3	RF IN	For input stage. Requires RF match and DC block.	
4	VBIAS	Supply for active bias.	
5	RF OUT/ VCC2	For output stage. Requires RF match, bias feed and DC block.	
6	RF OUT/ VCC2	See pin 5.	
7	RF OUT/ VCC2	See pin 5.	
8	RF OUT/ VCC2	See pin 5.	
Pkg Base	GND	Must be soldered to ground pad through as short a path as possible. This path also forms the thermal path for minimum T _J .	

Package Drawing

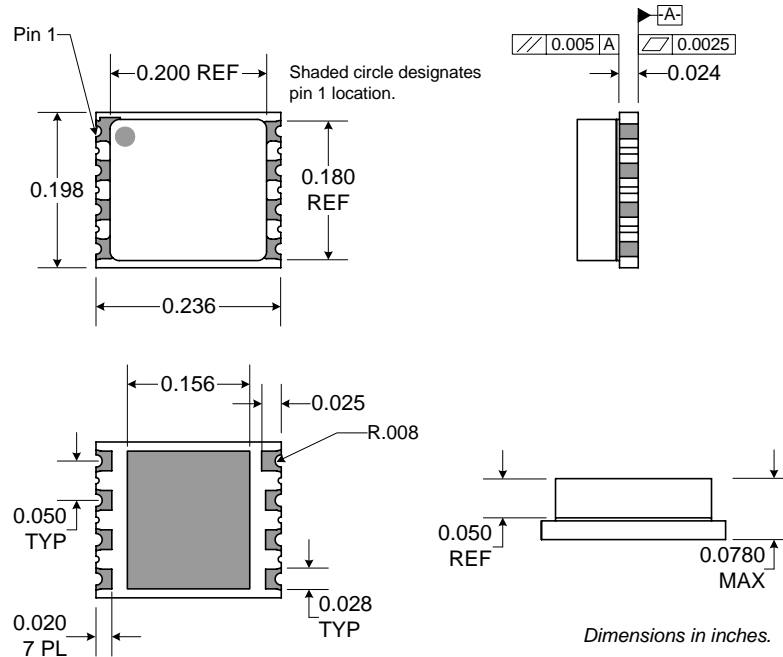

**Application Schematic - DCS/PHS/PCS
1800MHz to 2025MHz
Low Power Linear Operation**

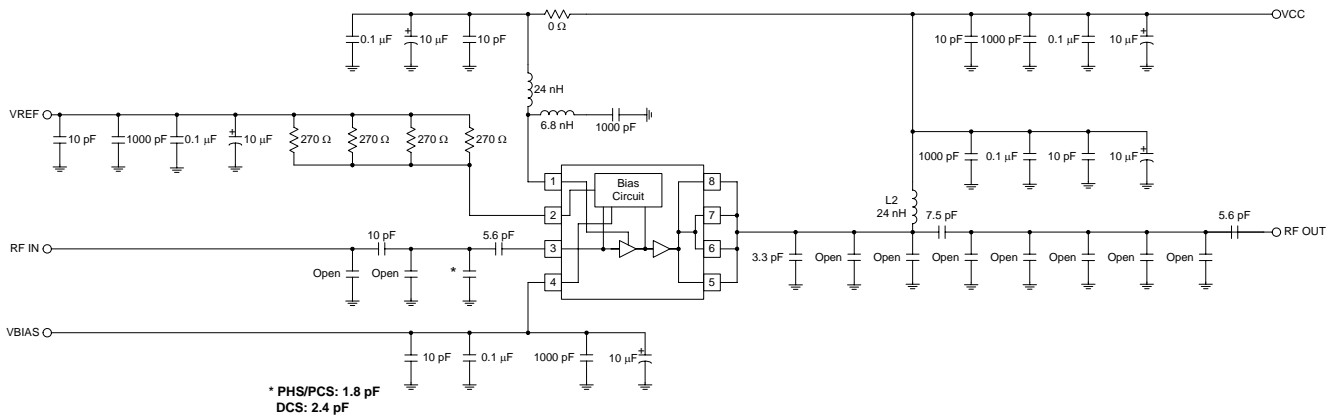

This schematic for low power linear operation:

$21\text{dBm} < P_{\text{OUT}} < 27\text{dBm}$, $5\text{V} \leq V_{\text{CC}} \leq 8\text{V}$. Bias R seen above for 8V and 60mA I_{REF} . See biasing table for setting resistance at other supply voltages.

**Application Schematic - DCS/PCS
1800MHz to 1990MHz
High Power Operation**

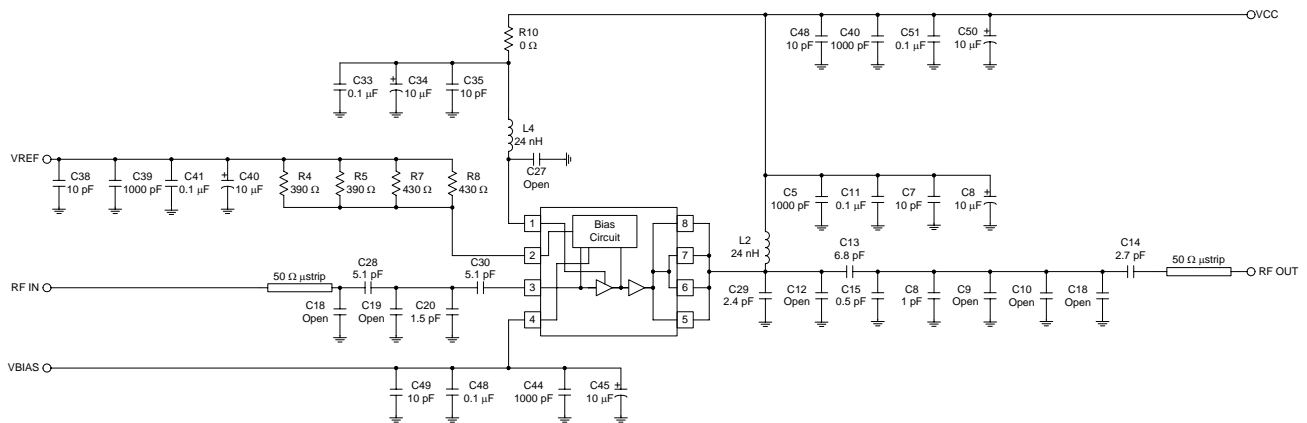

This schematic for high power operation:

$P_{\text{OUT}} > 27\text{dBm}$, $5\text{V} \leq V_{\text{CC}} \leq 8\text{V}$. Bias R seen above for 8V and 41mA I_{REF} . See biasing table for setting resistance at other supply voltages.

Evaluation Board Schematic - UMTS2100

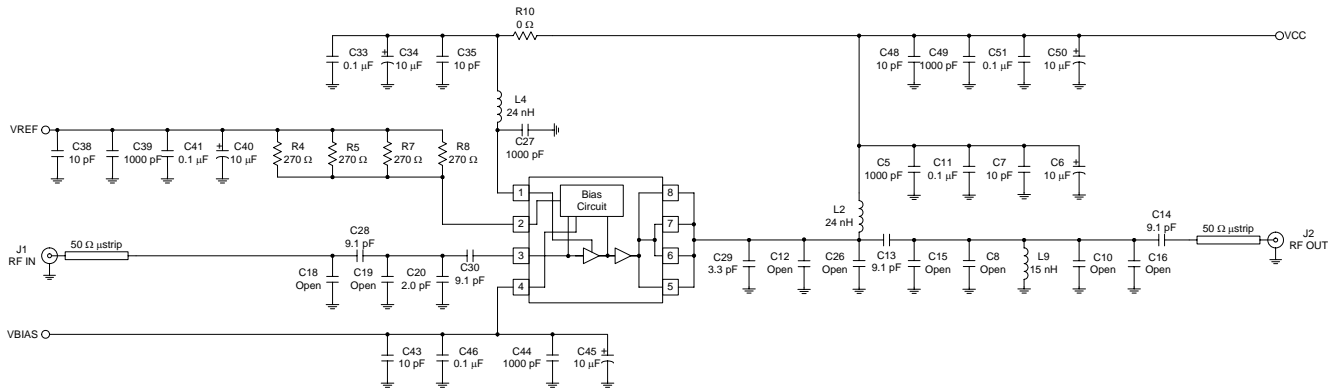

This eval board for low power linear operation: $21\text{ dBm} < P_{\text{OUT}} < 27\text{ dBm}$, $5\text{ V} \leq V_{\text{CC}} \leq 8\text{ V}$. Bias R seen above for 8V and 60mA I_{REF} . See biasing table for setting resistance at other supply voltages.

RF3806 Biasing Table

The resistor values shown below are for varied $V_{\text{CC}}/I_{\text{CQ}}$ conditions. Biasing for higher quiescent current will give increased linearity. "R_Bias" = equivalent R in line with V_{REF} (see values on evaluation board schematic: R4, R5, R7, R8).

Max allowable $I_{\text{REF}} = 60\text{ mA}$.

V_{CC}	V_{REF}	V_{BIAS}	R_{BIAS} (at V_{REF})	I_{REF}	Typical I_{CQ}
Volt	Volt	Volt	Ohm	mA	mA
8	8	8	62	60	730
7	7	7	45	60	726
6	6	6	28.5	60	718
5	5	5	11.5	60	707
8	8	8	80.5	50	676
7	7	7	60	50	670
6	6	6	40	50	663
5	5	5	20	50	649
8	8	8	105	41	623
7	7	7	80.5	41	614
6	6	6	56	41	601
5	5	5	31.5	41	584

In $I_{\text{REF}} = 60\text{ mA}$ case, calculated R_{BIAS} was rounded up to nearest 0.5Ω . This to keep I_{REF} at or slightly below 60mA max.

Evaluation Board Layout
Board Size 2.0" x 2.0"

Board Thickness 0.020", Board Material Rogers 4350

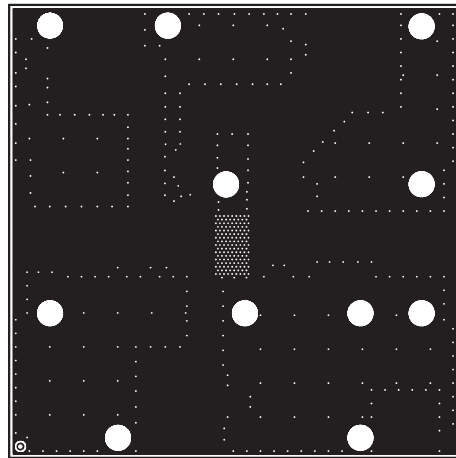
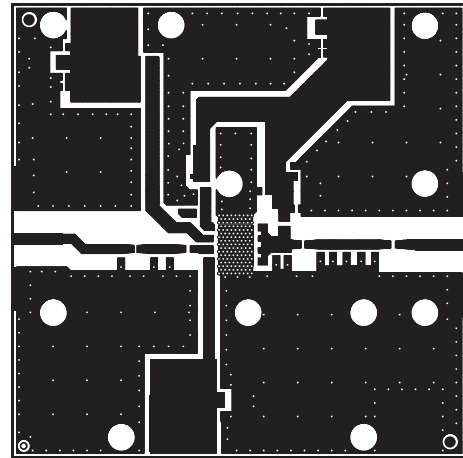
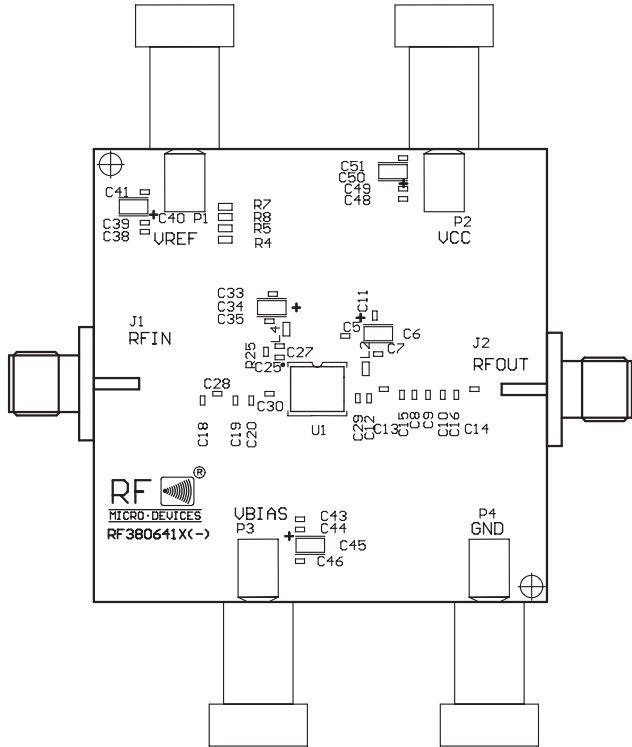

Theory of Operation

General biasing considerations can be described using RF3806 UMTS evaluation board as a reference. In actual system, $V_{CC}=V_{BIAS}=V_{REF}$ can be tied together when PA is to remain biased on at all times. For non-constant operation, V_{CC} is tied to V_{BIAS} , and V_{REF} used for turn-on preceding transmit. Table is provided in data sheet for adjusting I_{REF} to desired bias current for various supply voltage levels (more detailed discussion below).

RF3806 can be used in frequency bands ranging from 1500MHz to 2200MHz. Depending on specific application, the following parameters and their trade-offs can be considered: linearity, average output power, signal modulation/peak to average ratio (PAR), efficiency, dissipated power, junction temperature (Tj), and wear out MTTF. Looking at two distinct examples will demonstrate how the above mentioned parameters are taken into account. Note that much of the discussed performance can be found in the data sheet area showing graphs.

First, consider a UMTS pico cell base station transmitter (case 1). Here RF3806 fills the role of final PA, operating from 21dBm-26dBm P_{OUT} . V_{CC} can be run from 5V to 8V. Likewise, bias resistance on V_{REF} line can be set to obtain I_{REF} ranging from 41mA-60mA. The choice of voltage supply and bias is determined by required W-CDMA ACPR spec, desired P_{OUT} , and signal PAR. For instance, consider the following: $P_{OUT}=26$ dBm, frequency=2110MHz-2170MHz, signal=W-CDMA test model I 64 DPCH, ACPR requirement over temperature=-45dBc at 5MHz offset. The operating condition here (see data sheet graph section) would be $V_{CC}=8$ V and $I_{REF}=60$ mA, using impedance match found on UMTS Evaluation Board. For a lower output power requirement, I_{REF} is kept at 60mA, and V_{CC} reduced to a level below 8V. Sufficient linearity can be obtained at lower P_{OUT} , while the decrease in dissipated power yields a lower junction temperature and enhanced MTTF. For thermal considerations, refer to graphs provided for thermal resistance, junction temperature, and MTTF (these three graphs based on RF3806 thermal scan and process reliability data).

For the second example (case 2), consider a higher power application, where $P_{OUT}=34$ dBm and linearity requirement is substantially reduced from that seen in above example. For this application, we might run $I_{REF}=41$ mA with $V_{CC}=8$ V. RF3806 output load line would be set for maximum efficiency and compression point. The result is a transmit PA which obtains output power spec, while providing high enough efficiency to keep Tj within desired range. Running $I_{REF}=41$ mA avoids unnecessary power dissipation, as higher I_{REF} is used only in lower power case for linearity enhancement. A DCS/PCS application schematic is provided in data sheet for higher power applications, along with corresponding information in section containing graphs. UMTS evaluation board can be converted to the application schematic, with minor changes to input, output, and interstage matches (interstage @ V_{CC1} pin). Also, bias resistors at V_{REF} are scaled for lower $I_{REF}=41$ mA. EDGE ACP plots are provided in the graph section. Note that the matching also covers transmit bands for 1850-1910 CDMA. As a result, this converted application board could also be considered for CDMA booster/repeater.

As mentioned above, junction temperature is an important consideration when operating at maximum V_{CC} (8V). The most demanding scenario, case 1 above, will be considered here as an illustration. In the data sheet graph section, refer to graphs of Tj vs P_{OUT} , R_{TH} vs P_{OUT} , and RF3806 wear out MTTF vs Tj. During thermal scan, RF3806 eval board is affixed to a large, temperature controlled stage, held at ambient. The device is etched open, such that thermal image of die can be taken. Reference temperature is measured at evaluation board to stage interface by thermocouple, placed through a thin groove such that it makes contact with underside eval board GND plane (directly beneath RF3806). Thermocouple measures "reference temperature", from which R_{TH_JREF} (junction to reference) is determined. Evaluation board thermal resistance, R_{TH_BOARD} , has been modeled at 1°C/W. Knowing these two values allows us to calculate junction to case thermal resistance of RF3806= $R_{TH_JC}=R_{TH_JREF}-R_{TH_BOARD}=R_{TH_JREF}-1$ (see graph). Thus, R_{TH_JC} is defined as thermal resistance from junction to GND slug of device.

At $P_{OUT}=26\text{dBm}$, see that $T_j=160^\circ\text{C}$ for ambient (stage) temperature= 85°C . At this condition, temperature of case (GND slug) is calculated:

$T_{CASE}=T_{REF}+P_{DISS}*(R_{TH_BOARD})=94^\circ\text{C}+(6.191\text{W})*1^\circ\text{C/W}=100.2^\circ\text{C}$. Note that T_{REF} was elevated to 94°C when stage was set at 85°C . Thus, thermal resistance results can be subject to where one defines "ambient".

Using MTTF curve, it is seen that $MTTF=80$ years for 160°C junction temperature. In a design where higher MTTF is desired, one option would be to run RF3806 at reduced V_{CC} . Viewing UMTS ACP curves in graph section of data sheet, $V_{CC}=6\text{V}/25\text{dBm}$ shows equivalent linearity to $V_{CC}=8\text{V}/26\text{dBm}$. Reducing P_{OUT} specification to 25dBm will allow for higher MTTF while operating at $V_{CC}=6\text{V}$. A practical approximation to T_j at adjusted operating condition can be made. Assume T_{CASE} equal to 100.2°C , as with $V_{CC}=8\text{V}$ and 26dBm out (conservative estimate). Dissipated power for $6\text{V}/25\text{dBm}/85^\circ\text{C}$ is known from test data to be 4.385W . From data sheet graph, $R_{TH_JC}=9.95^\circ\text{C/W}$. T_j is approximated to be:

$$T_j=100.2+4.385*9.95=144^\circ\text{C}$$

MTTF curve shows >450 years for this T_j . As mentioned, the above analysis is not exact, but does give us a practical way to get an idea of where a condition will fall in terms of T_j and MTTF. Required data to do the calculation: data sheet curves and evaluation board test in temperature chamber (to determine dissipated power).

Note that projected T_j vs P_{out} curves are included with DCS/PCS data ($1800\text{MHz}-1990\text{MHz}$ high power application schematic), to illustrate the same type of trade offs between operating at 6V and 8V . These curves are approximate, obtained with the following method (called out in above paragraph):

1. UMTS evaluation board was converted to matching seen on DCS/PCS application schematic (changes @ input/output/interstage/bias resistors at V_{REF}).
2. Evaluation board was run in oven at 85°C ambient.
3. Dissipated power was calculated at each data point. Using R_{TH_JREF} from data sheet curve, temperature delta to RF3806 junction (T_j) can be obtained. T_j was then plotted, and can be applied to MTTF vs T_j curve.

Finally, a description is included here for running two RF3806 in parallel with hybrid combiners. This approach enables design to achieve substantial linearity enhancement for a given P_{OUT} , while maintaining low die temperature. In this example, hybrid couplers (combiners) from Anaren (part number XC2100E-03) are used with 2 RF3806 UMTS evaluation boards. The bias condition is $V_{CC}=6\text{V}$, $I_{REF}=60\text{mA}$. ACP performance vs temperature is shown in graph section, which can be compared to that for single PA.

RFMD can be contacted to obtain RF3806 qualification report, which adheres to demanding infrastructure standards.

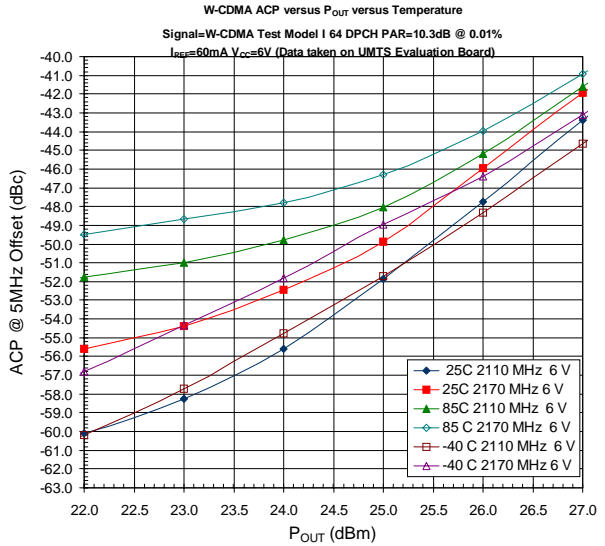
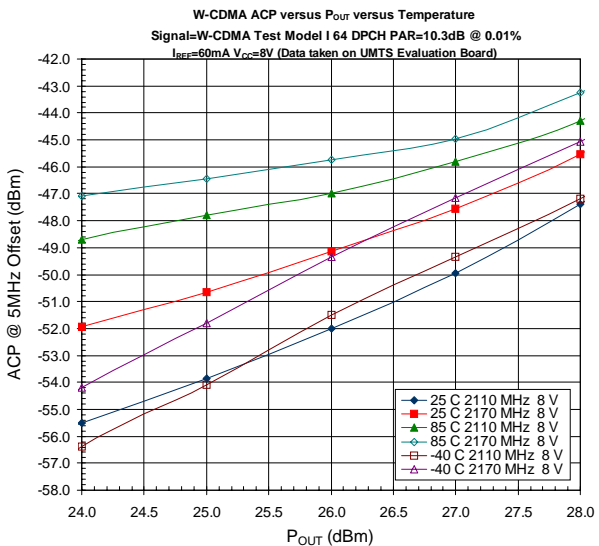
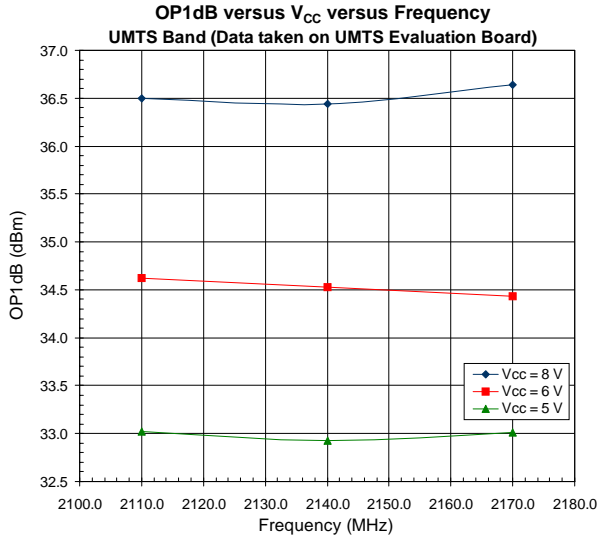
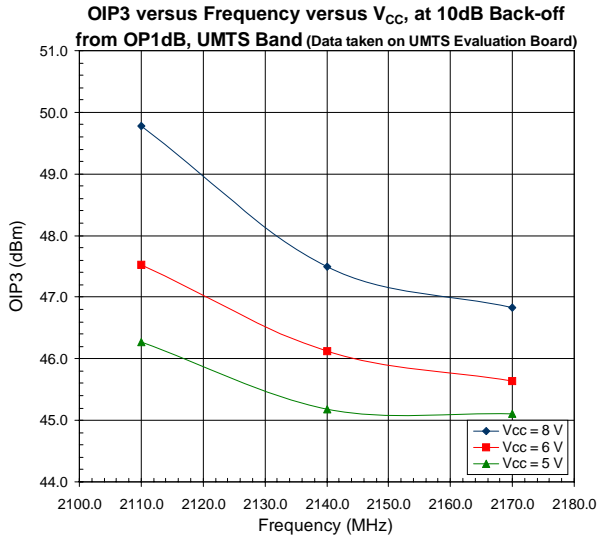
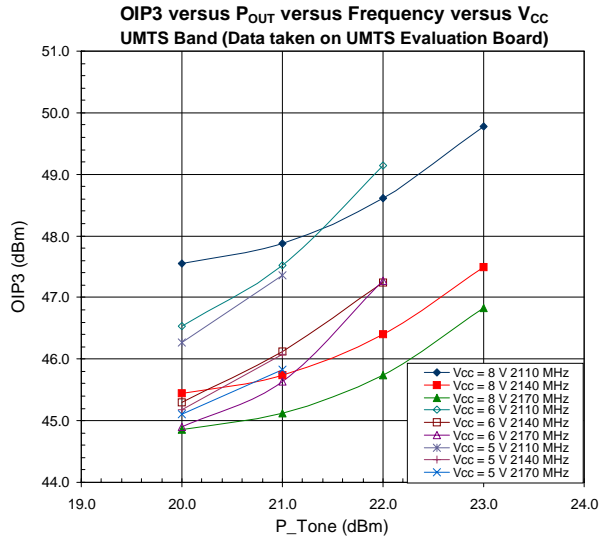
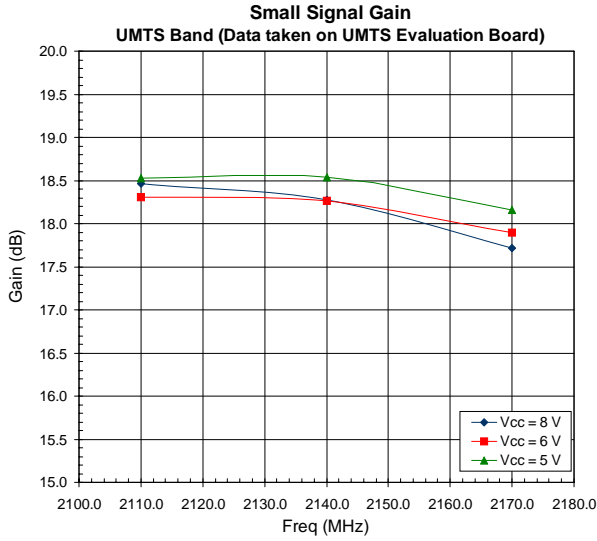

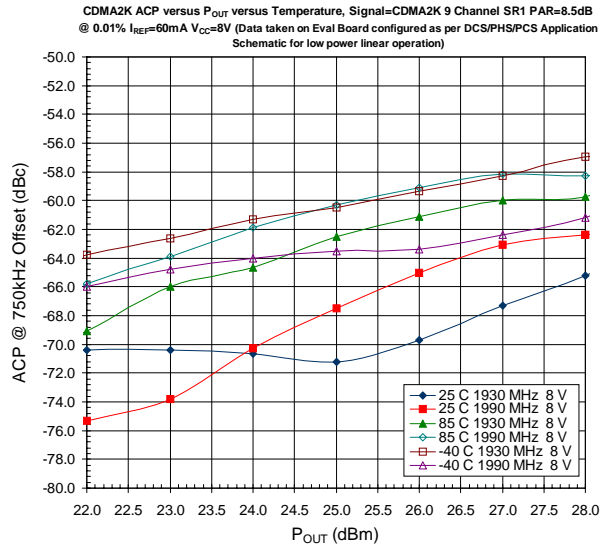
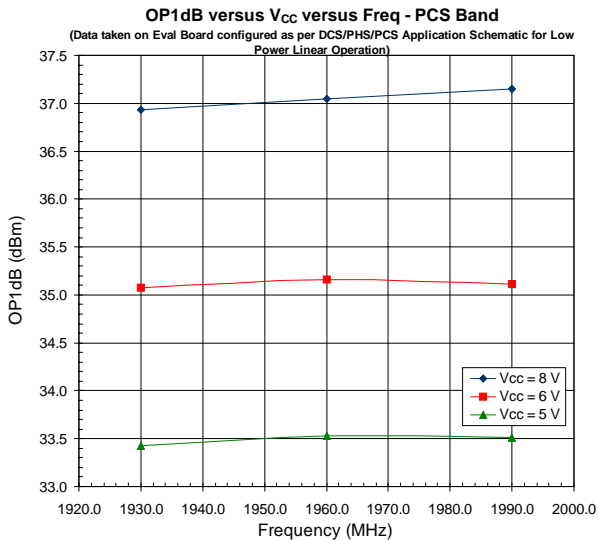
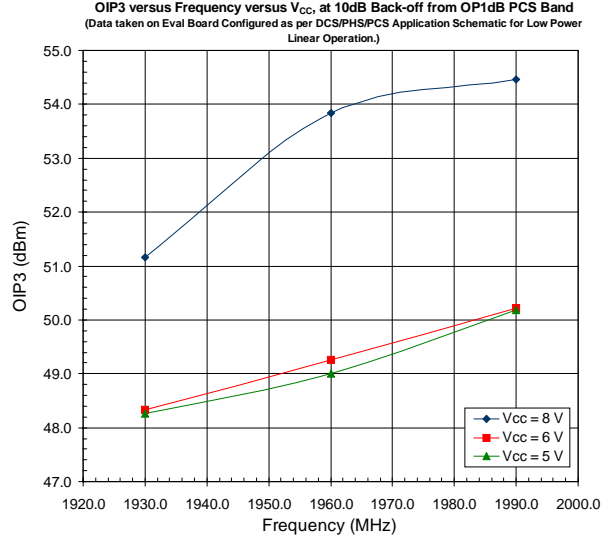
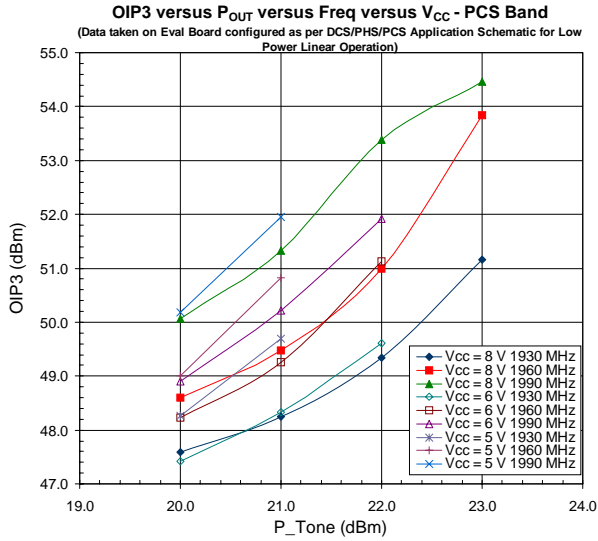
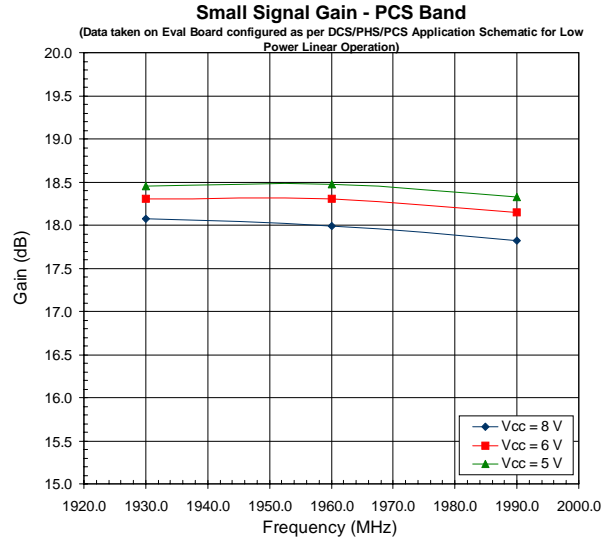
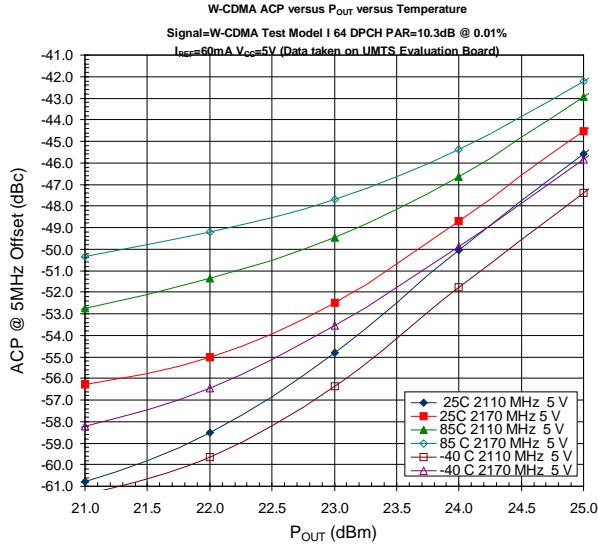

CDMA2K ACP versus P_{OUT} versus Temperature, Signal=CDMA2K 9 Channel SR1 PAR=8.5dB
 @ 0.01% I_{REF}=60mA V_{CC}=6V (Data taken on Eval Board configured as per DCS/PHS/PCS Application Schematic for low power linear operation)

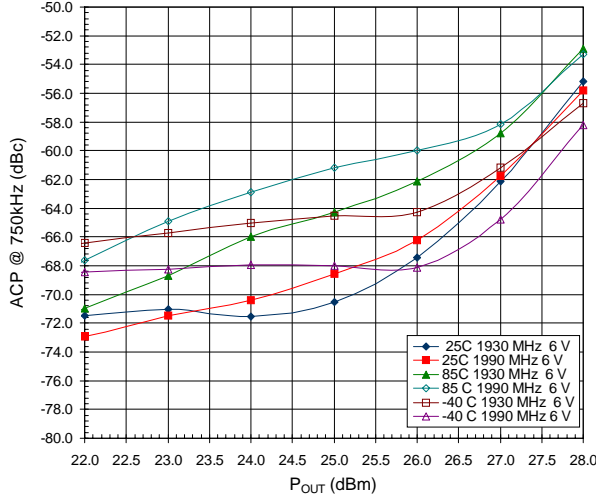

CDMA2K ACP versus P_{OUT} versus Temperature, Signal=CDMA2K 9 Channel SR1 PAR=8.5dB
 @ 0.01% I_{REF}=60mA V_{CC}=5V (Data taken on Eval Board configured as per DCS/PHS/PCS Application Schematic for low power linear operation)

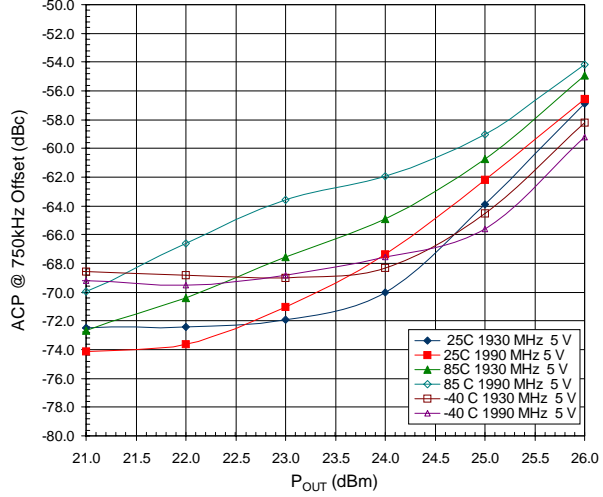

DCS/PCS EDGE ACP V_{CC}=8V I_{REF}=41mA
 (See DCS/PCS High Power Application Schematic, 1800MHz to 1990MHz)

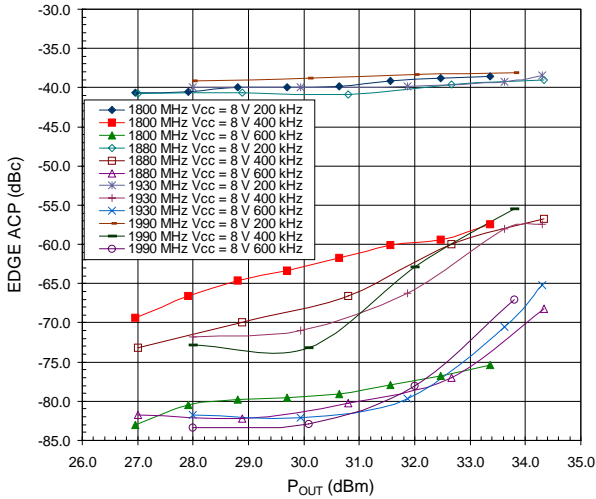

DCS/PCS EDGE ACP V_{CC}=6V I_{REF}=41mA
 (See DCS/PCS High Power Application Schematic, 1800MHz to 1990MHz)

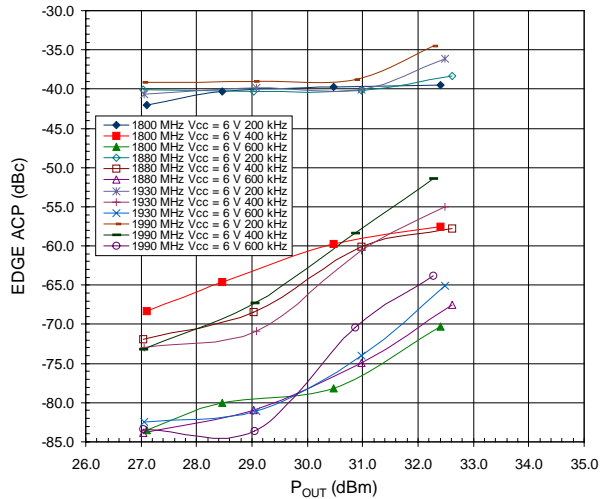

DCS/PCS OP1dB I_{REF}=41mA
 (See DCS/PCS High Power Application Schematic, 1800MHz to 1990MHz)

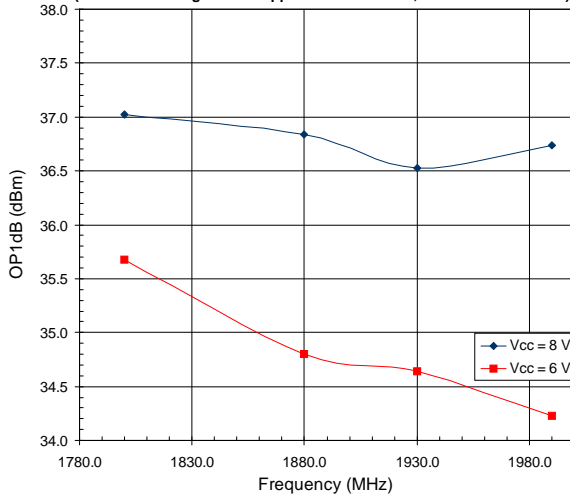

DCS/PCS Projected Junction Temperature at 85°C Ambient
 (See Theory of Operation section, and DCS/PCS High Power Application Schematic, 1800MHz to 1990MHz) I_{REF}=41mA

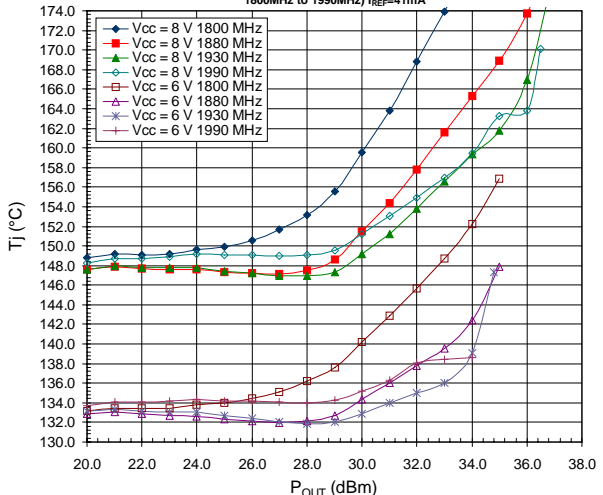

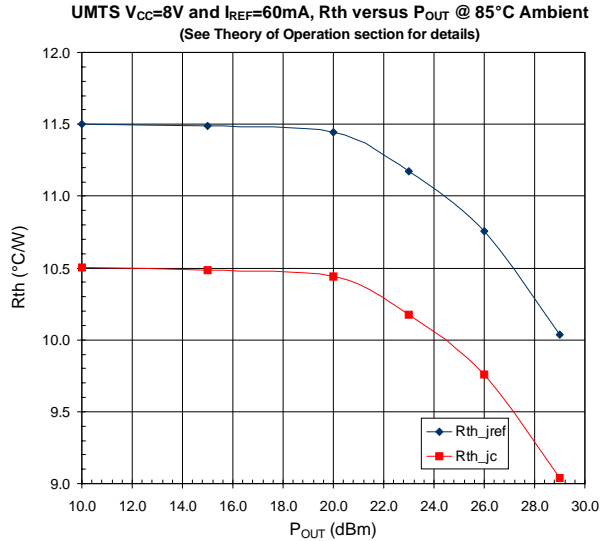
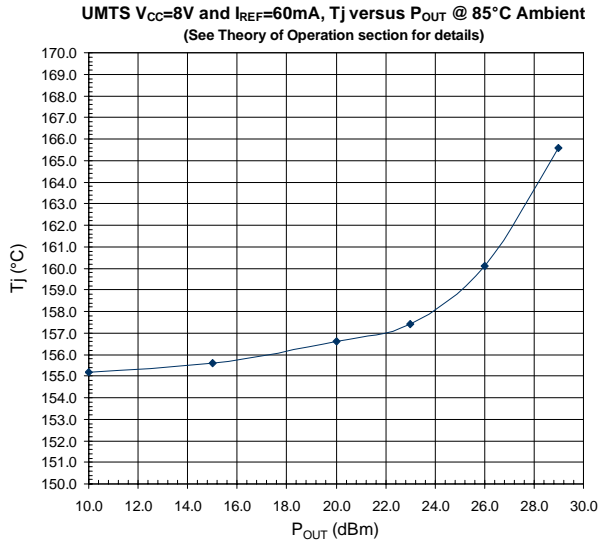
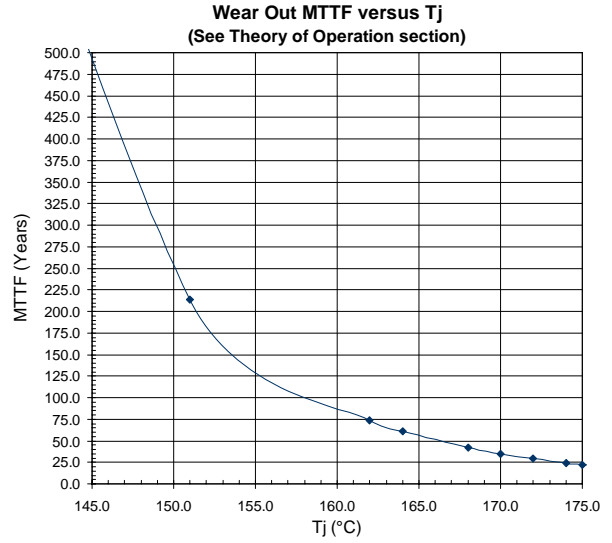
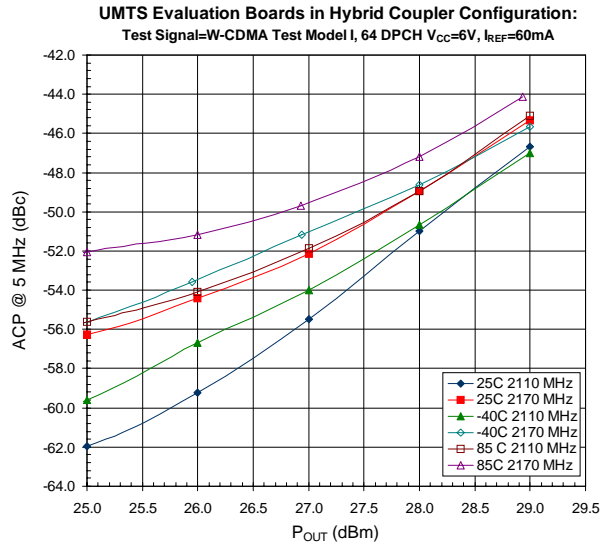

DCS/PCS High Power Application Schematic, Typical Response

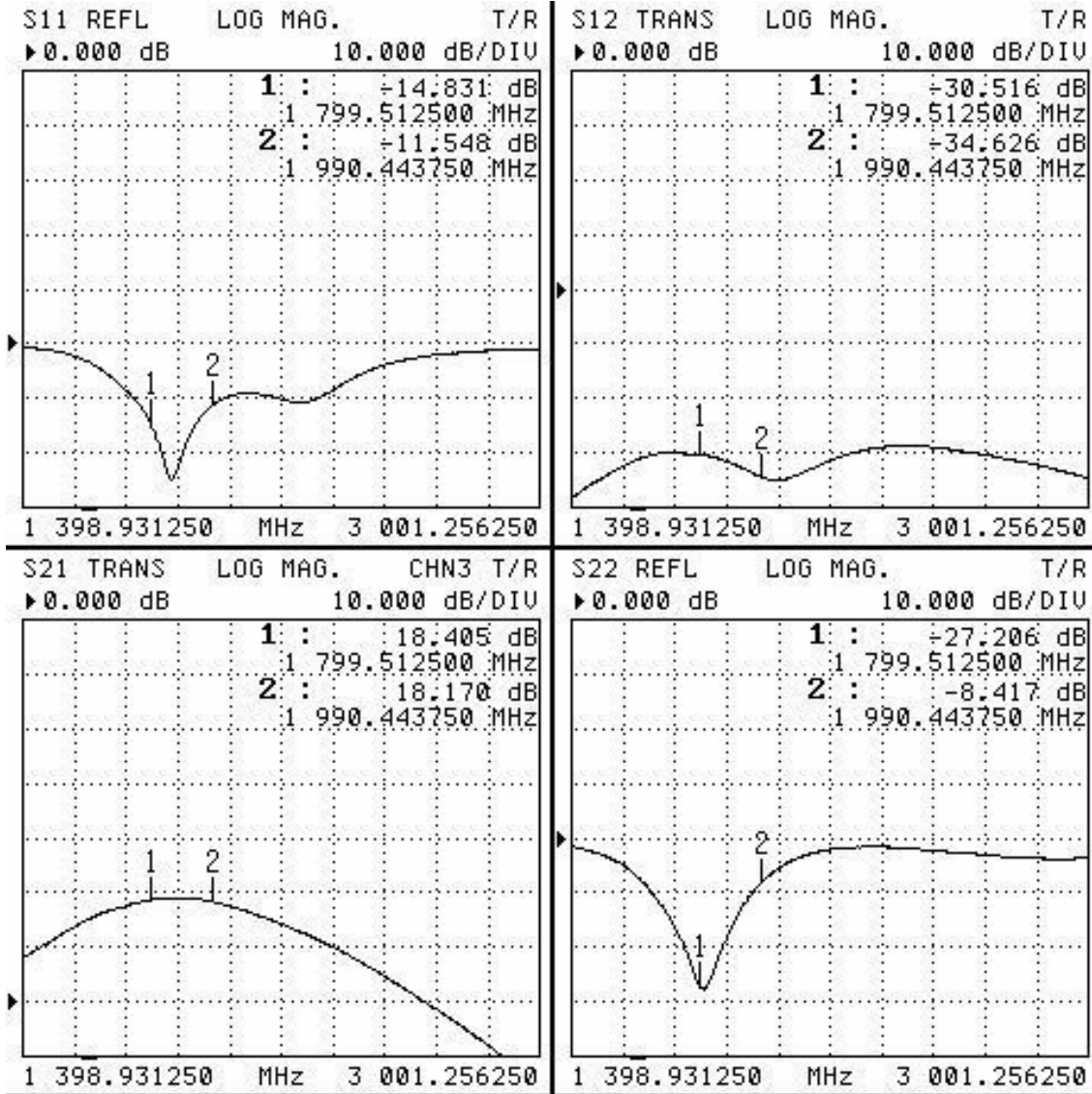

PCS/PHS/PCS Low Power Linear Application Schematic, Typical Response

(Input matched for PCS, see data sheet schematic)

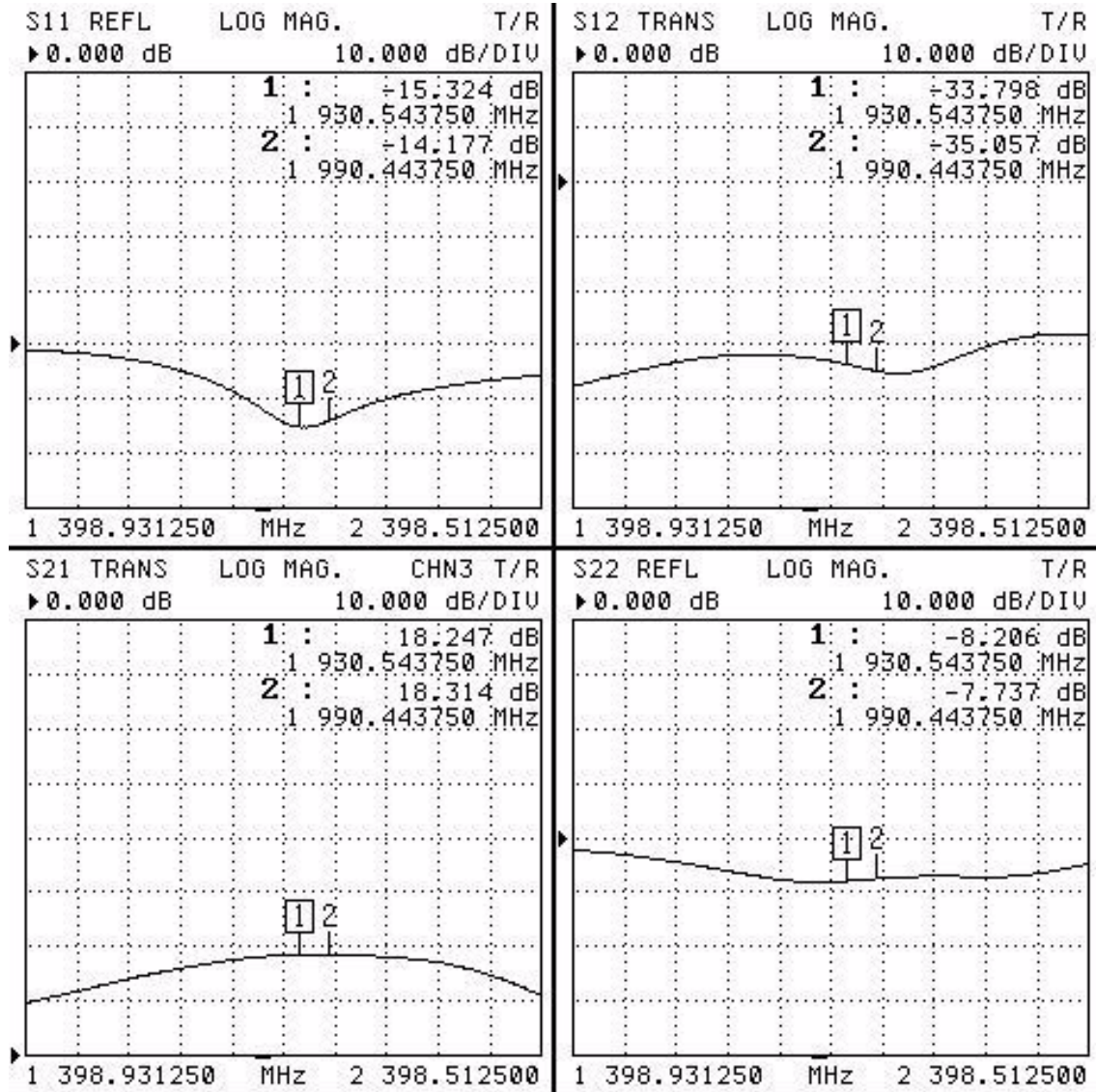

UMTS Evaluation Board Typical Response

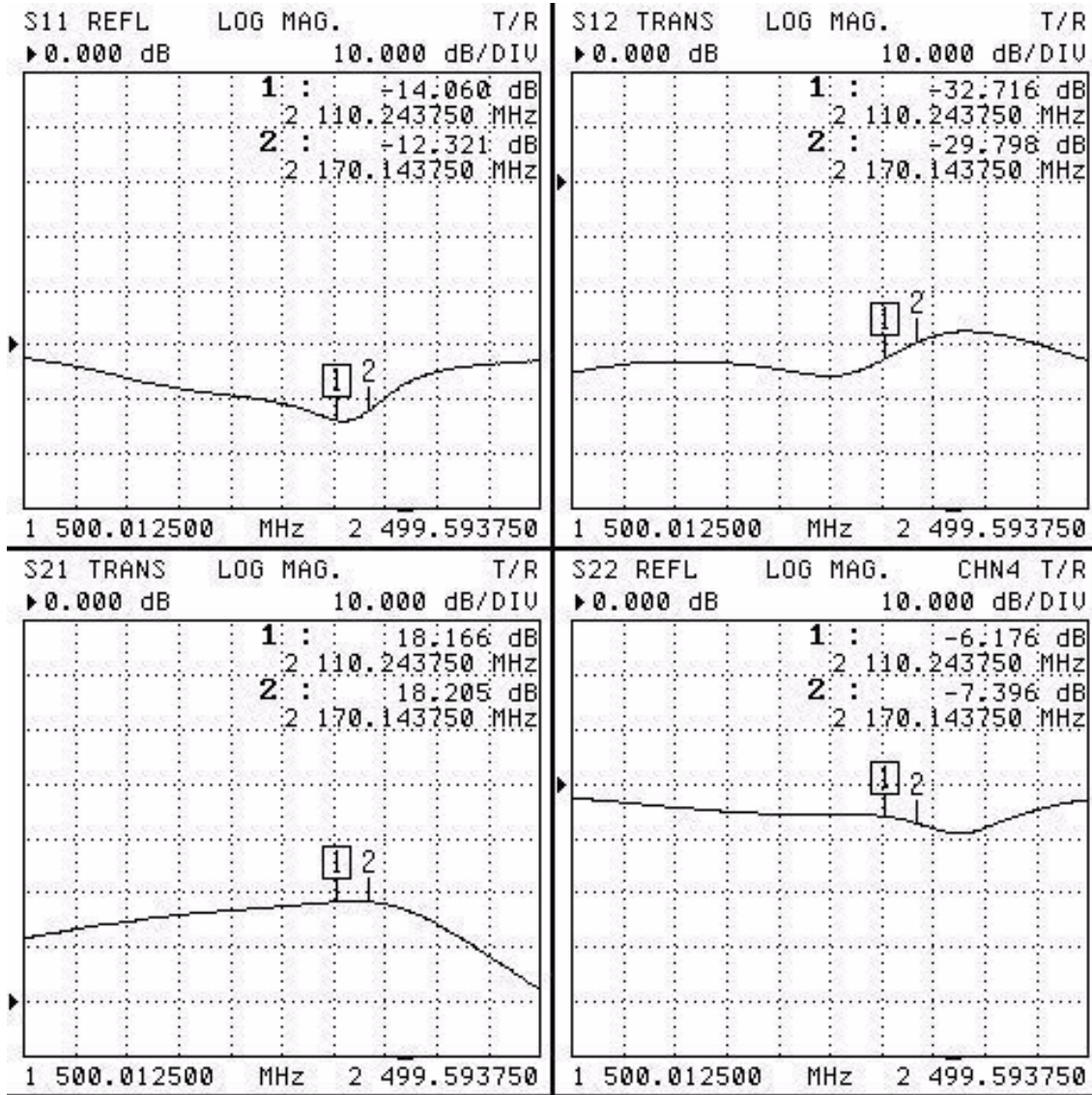

UMTS Evaluation Boards in Hybrid Coupler Configuration, Typical Response

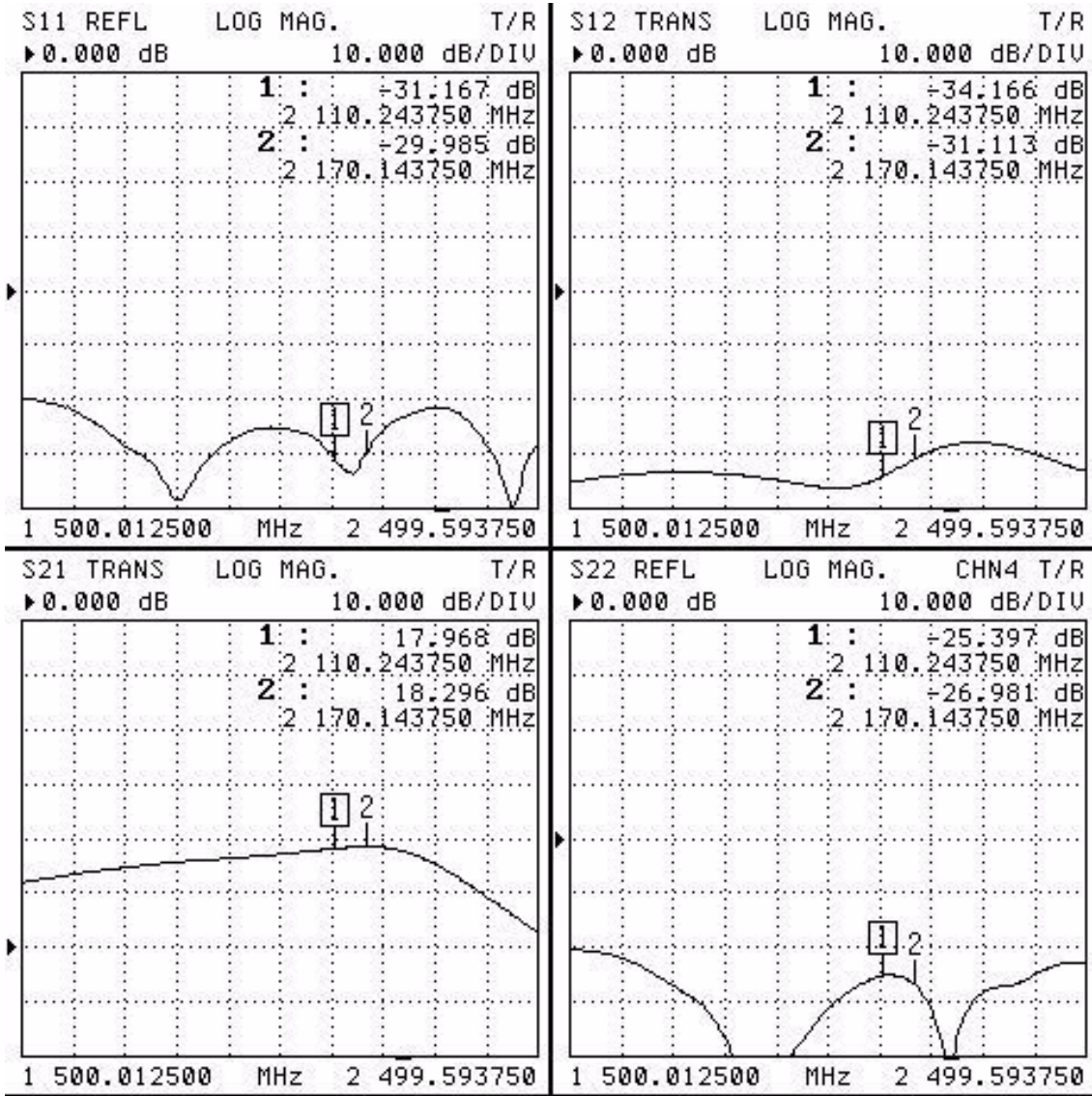

PCB Design Requirements

PCB Surface Finish

The PCB surface finish used for RFMD's qualification process is electroless nickel, immersion gold. Typical thickness is 3µinch to 8µinch gold over 180µinch nickel.

PCB Land Pattern Recommendation

PCB land patterns are based on IPC-SM-782 standards when possible. The pad pattern shown has been developed and tested for optimized assembly at RFMD; however, it may require some modifications to address company specific assembly processes. The PCB land pattern has been developed to accommodate lead and package tolerances.

PCB Metal Land Pattern PCB Solder Mask Pattern

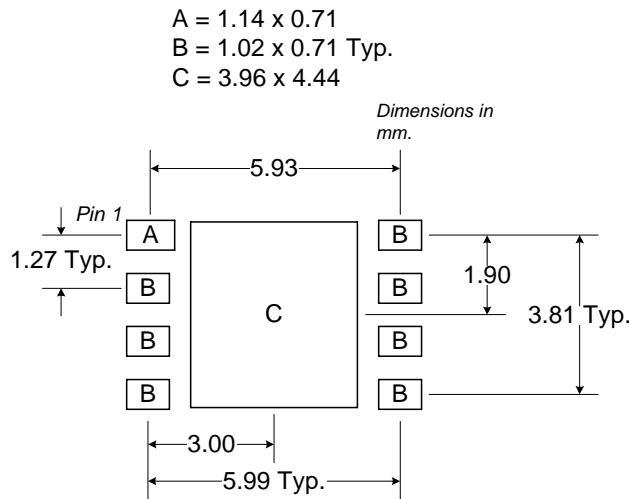

Liquid Photo-Imageable (LPI) solder mask is recommended. The solder mask footprint will match what is shown for the PCB metal land pattern with a 2mil to 3mil expansion to accommodate solder mask registration clearance around all pads. The center-grounding pad shall also have a solder mask clearance. Expansion of the pads to create solder mask clearance can be provided in the master data or requested from the PCB fabrication supplier.

A = 1.30 x 0.86
 B = 1.17 x 0.86 Typ.
 C = 4.11 x 4.60

Dimensions in mm.

