

## 阅读申明

- 1.本站收集的数据手册和产品资料都来自互联网，版权归原作者所有。如读者和版权方有任何异议请及时告之，我们将妥善解决。
- 2.本站提供的中文数据手册是英文数据手册的中文翻译，其目的是协助用户阅读，该译文无法自动跟随原稿更新，同时也可能存在翻译上的不当。建议读者以英文原稿为参考以便获得更精准的信息。
- 3.本站提供的产品资料，来自厂商的技术支持或者使用者的心得体会等，其内容可能存在描述上的差异，建议读者做出适当判断。
- 4.如需与我们联系，请发邮件到marketing@iczoom.com，主题请标有“数据手册”字样。

## Read Statement

1. The datasheets and other product information on the site are all from network reference or other public materials, and the copyright belongs to the original author and original published source. If readers and copyright owners have any objections, please contact us and we will deal with it in a timely manner.
2. The Chinese datasheets provided on the website is a Chinese translation of the English datasheets. Its purpose is for reader's learning exchange only and do not involve commercial purposes. The translation cannot be automatically updated with the original manuscript, and there may also be improper translations. Readers are advised to use the English manuscript as a reference for more accurate information.
3. All product information provided on the website refer to solutions from manufacturers' technical support or users the contents may have differences in description, and readers are advised to take the original article as the standard.
4. If you have any questions, please contact us at marketing@iczoom.com and mark the subject with "Datasheets" .

# Acuta Standard GPS Antenna

Part No. A10415

Product Specification

## 1 Features

- GPS antenna designed for embedded applications
- Small size and light weight (0.5g)
- High performance
- Upward hemispherical RHCP pattern
- Simple matching circuit tuning
- Works in many different positions in the device
- No extra mechanical support required

## 2 Description

Acuta GPS antenna is an innovative high performance GPS antenna designed to replace ceramic patch antennas, reduce development costs and improve time-to-market – all without compromising performance. The very slim A10415 allows a substantial reduction in the minimum thickness of the host device compared to a solution using a 12x12mm<sup>2</sup> ceramic patch antenna.

Acuta is intended to be mounted at the edge of the host PCB facing the sky, in a similar way to a conventional patch antenna, which generates an almost hemispherical radiation pattern towards the sky - achieving optimal GPS performance.

Acuta GPS antenna is intended for reception of GPS signals at 1575 MHz and is easily tuned using a simple matching circuit on the host PCB, allowing the same antenna to be used in different devices without physical modifications. The antenna is soldered directly onto the host PCB, without the need of expensive coaxial cables, RF connectors or mounting frames, significantly reducing the total BOM of the GPS solution.

The antenna uses a ground plane in order to radiate efficiently, which should be at least 30 x 30 mm.

## 3 Applications

- Portable Navigation Devices (PNDs)
- GPS Trackers
- Mobile phones/ Smart phones
- Notebooks / Tablets / eReaders
- M2M

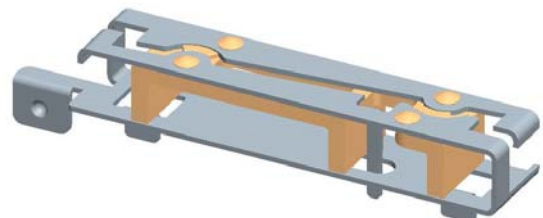

## 4 Part number

**Acuta: A10415**



(Bottom View)

## 5 General data

Product name	Acuta
Part Number	A10415
Frequency	GPS - 1575 MHz
Polarization	Linear
Operating temperature	-40 °C to +85 °C
Impedance with matching	50 Ω
Weight	0.5 g
Antenna type	Metal
Dimensions (LxWxH)	25.0 x 5.0 x 4.3 [mm] (Effective) 29.6 x 5.0 x 6.8 [mm] (Total)

## 6 Electrical characteristics

	Typical performance Reference Board A10415-U1	Conditions
Bandwidth (Typical)	30 MHz at -10 dB Return Loss	All data measured on Antenna's reference board, part number A10415-U1  Data given for the 1573.42 – 1577.42 MHz frequency range
Peak gain (Linear)	+0.4 dB	
Average gain (Linear)	-2.2 dB	
Average efficiency (Linear)	60%	
Peak gain (RHCP)	-1.0 dB	
Average gain (RHCP)	-3.9dB	
Average efficiency (RHCP)	40%	
Maximum Return Loss	-10 dB	
Maximum VSWR	2:1	

## 7 Electrical performance

### 7-1 Return Loss (with matching circuit)

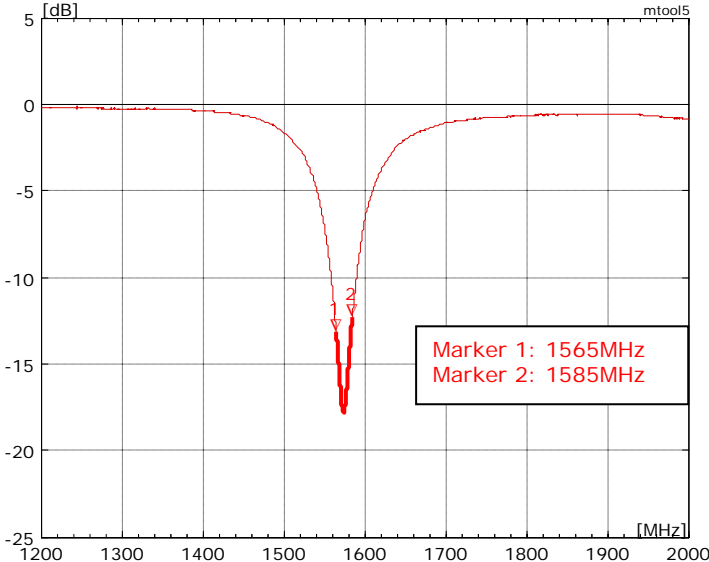

Reference Board A10415-U1

### 7-2 VSWR (with matching circuit)

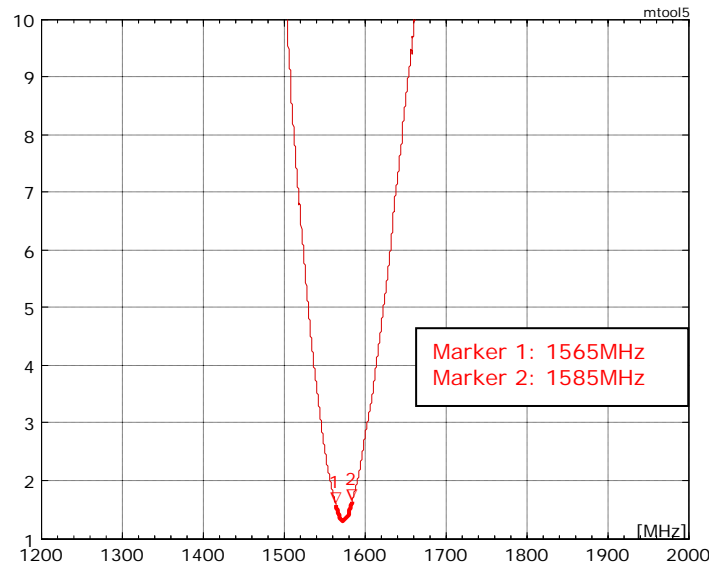

Reference Board A10415 -U1

### 7-3 Antenna patterns 1575MHz

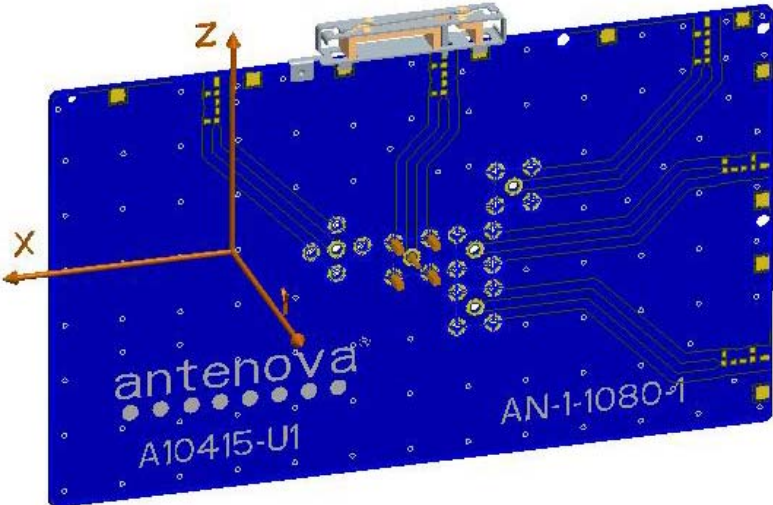

A10415-U1 Ref Board

— TOTAL (RHCP+LHCP)  
— RHCP ONLY

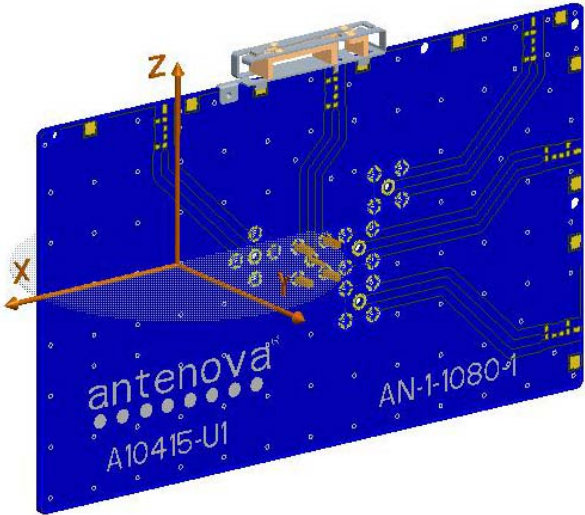
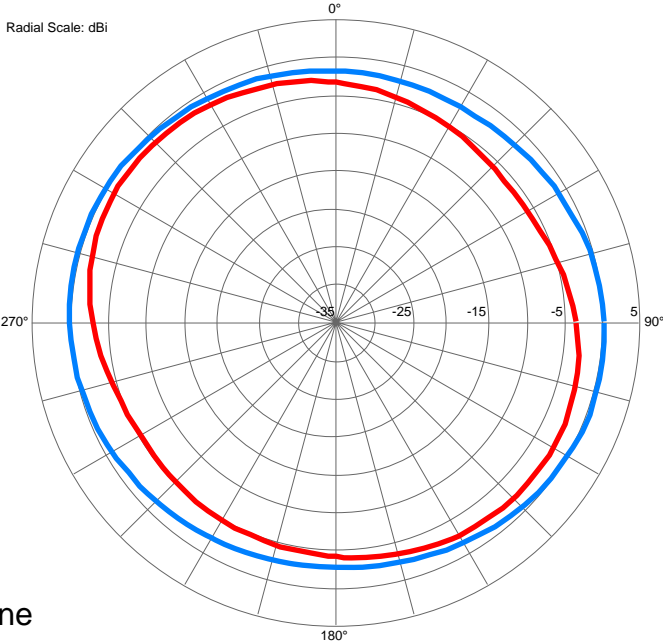

XY Plane

Acuta Standard GPS Antenna  
Part No. A10415

— TOTAL (RHCP+LHCP)  
— RHCP ONLY

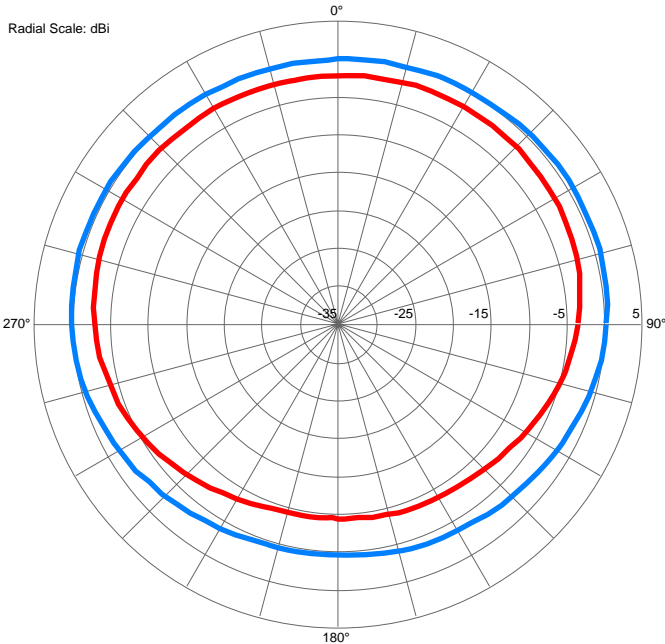
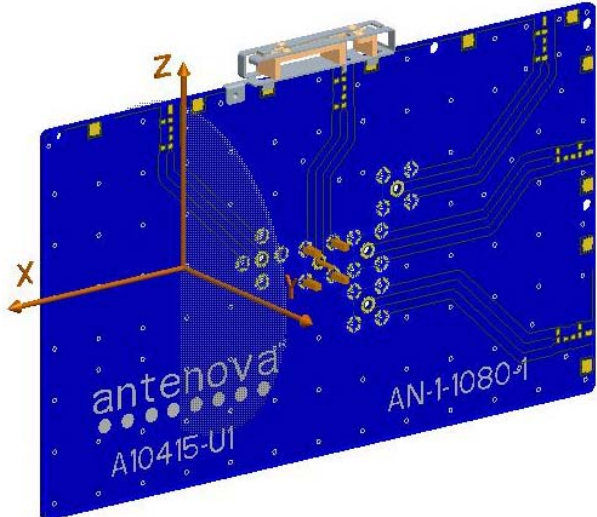

ZY Plane

— TOTAL (RHCP+LHCP)  
— RHCP ONLY

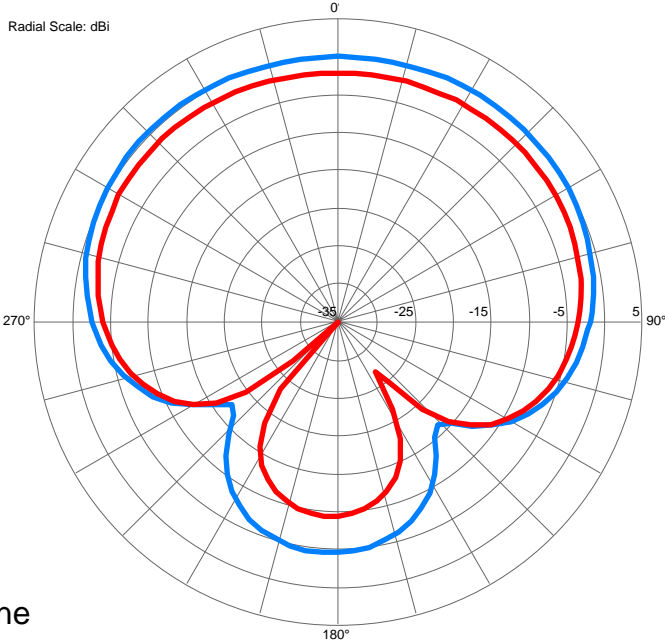
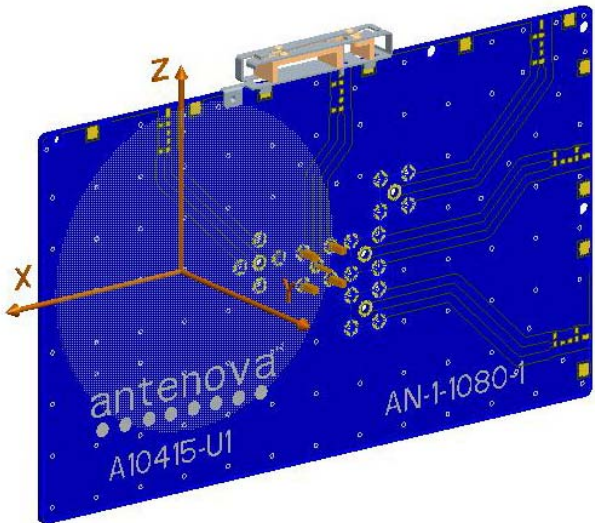

XZ Plane

Integrated Antenna and RF Solutions



### 8 Antenna dimensions

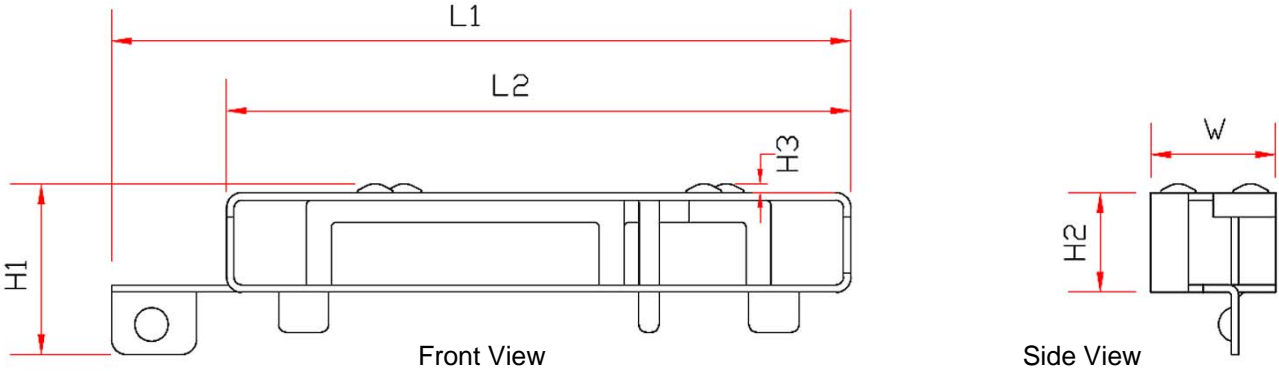

L1	L2	W	H1	H2	H3
Length1	Length2	Width	Height1	Height2	Height3
29.6 ± 0.2	25.0 ± 0.2	5.0 ± 0.2	6.8 ± 0.15	4.0 ± 0.15	0.3 ± 0.1

Dimensions in mm

# 9 Antenna footprint

GPS Antenna (Part No: A10415)

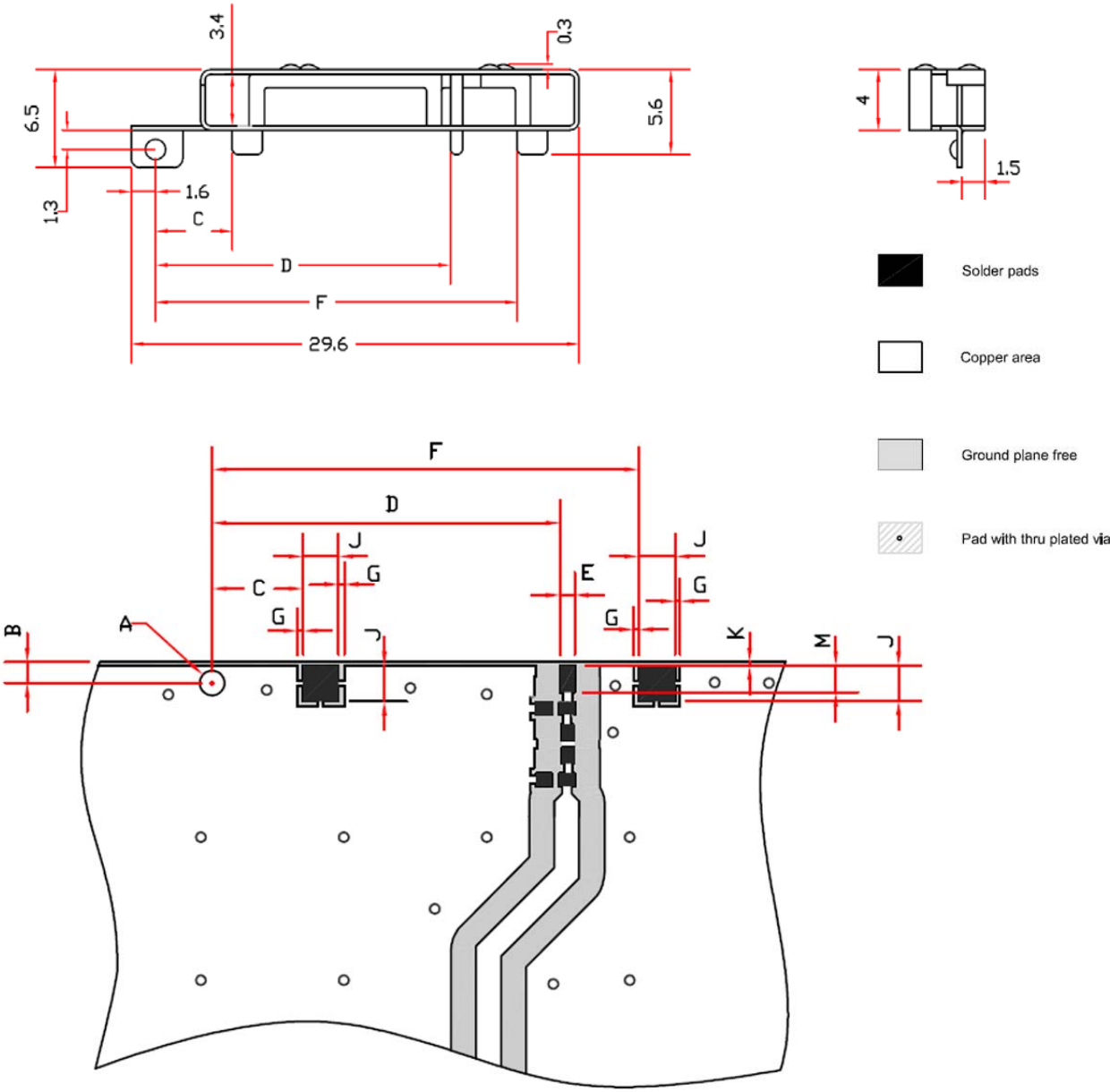

A	B	C	D	E	F	G	J	K	M
1.4	1.2	5.1	19.5	0.8	23.9	0.3	2.0	0.2	1.5

Dimensions in mm. Tolerances for all dimensions on this table are ± 0.1 mm.

\* CAD files of the antenna footprint are available from Antenova on request. Please contact [info@antenova.com](mailto:info@antenova.com) for further details.



## 10 Electrical interface

### 10-1 Transmission lines

- All transmission lines should be designed to have a characteristic impedance of 50  $\Omega$
- The length of the transmission lines should be kept to a minimum
- Any other parts of the RF system like transceivers, power amplifiers, etc, should also be designed to have an impedance of 50  $\Omega$

Once the material for the PCB has been chosen (PCB thickness and dielectric constant), a coplanar transmission line can easily be designed using any of the commercial software packages for transmission line design. For the chosen PCB thickness, copper thickness and substrate dielectric constant, the program will calculate the appropriate transmission line width and gaps on either side of the track so the characteristic impedance of the coplanar transmission line is 50  $\Omega$ .

## 10-2 Matching circuit

The A10415 antenna is designed to resonate at a frequency slightly higher than the GPS band, and a matching circuit is required to tune the antenna to the exact frequency; in this way the antenna can be used in many different devices just by changing the matching circuit.

The matching circuit typically required just two passive components (inductors/capacitors); however, a three component PI-network like the one in the picture below is recommended for safe-proofing. The matching circuit must be placed as close as possible to the feed pin of the antenna.

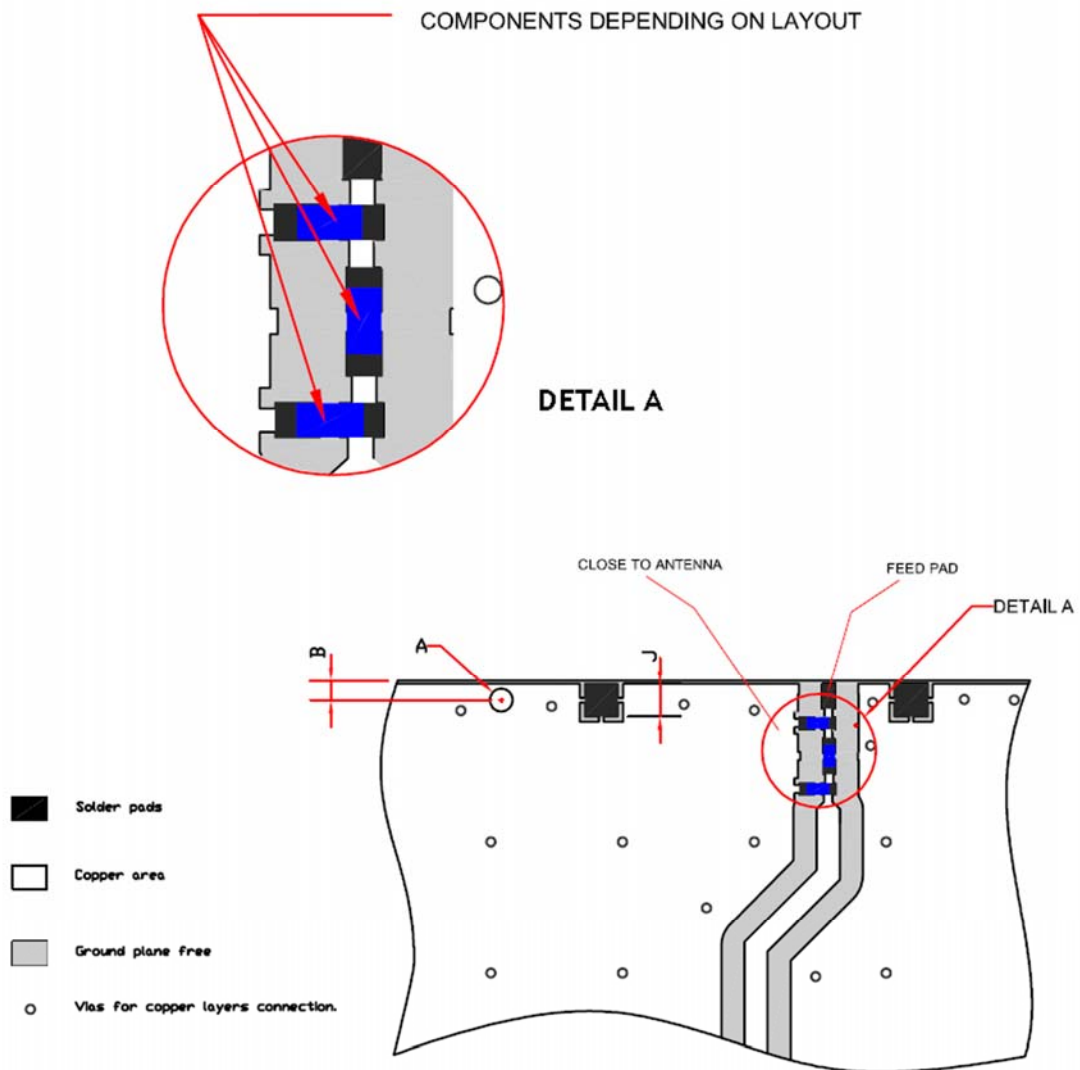

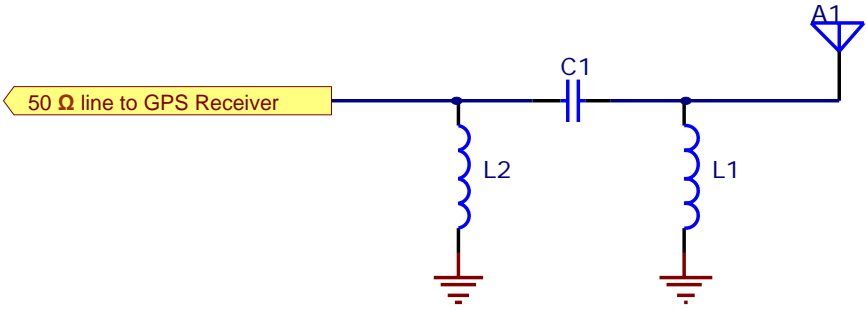

In a typical application, the following values for the components could be used as a starting point in the matching process:

Designator	Value
L1	6.8nH
C1	1.0pF
L2	Not fitted

Use of reasonable high Q inductors (e.g. Murata LQW15 series) is recommended for the inductors; as typically the value of the series capacitor is quite small, the use of tight tolerance capacitors is recommended.

**Note:** The component values for the matching circuit will vary depending on how close to the antenna the device’s plastic case is, the size of the host PCB and surrounding components. The impedance of the antenna should be measured before selecting suitable matching components. Antenova offers this service on request. Contact info@antenova.com for further information.

### 10-3 Antenna placement

The A10415 is designed to give optimal performance when mounted along the top-edge of the device PCB, facing the sky during the normal use scenario. Recommended position is indicated on the Acuta reference board A10415-U1 (shown below).

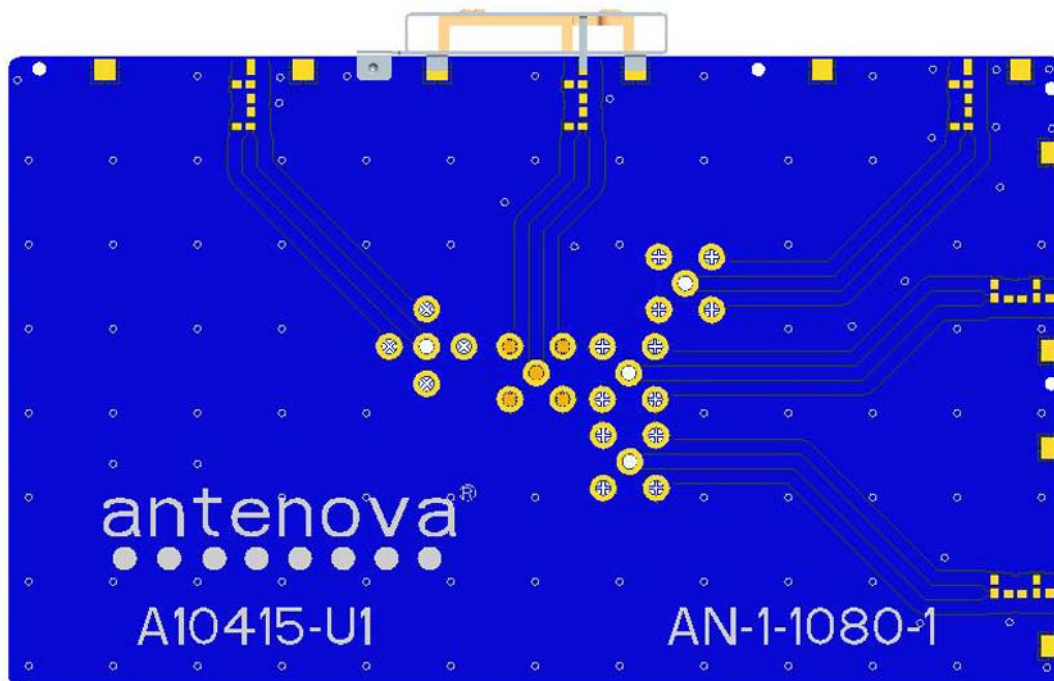

However, the antenna can also work well when placed in other locations in the device. Please contact Antenova FAE for recommendations about alternative antenna placements or unusual use scenarios.

## 10-4 Reference board

The reference board has been designed for evaluation purposes of the Acuta GPS antenna and comes fitted with a SMA female connector. The A10415-U1 reference board also allows testing of the antenna in five different mounting positions.

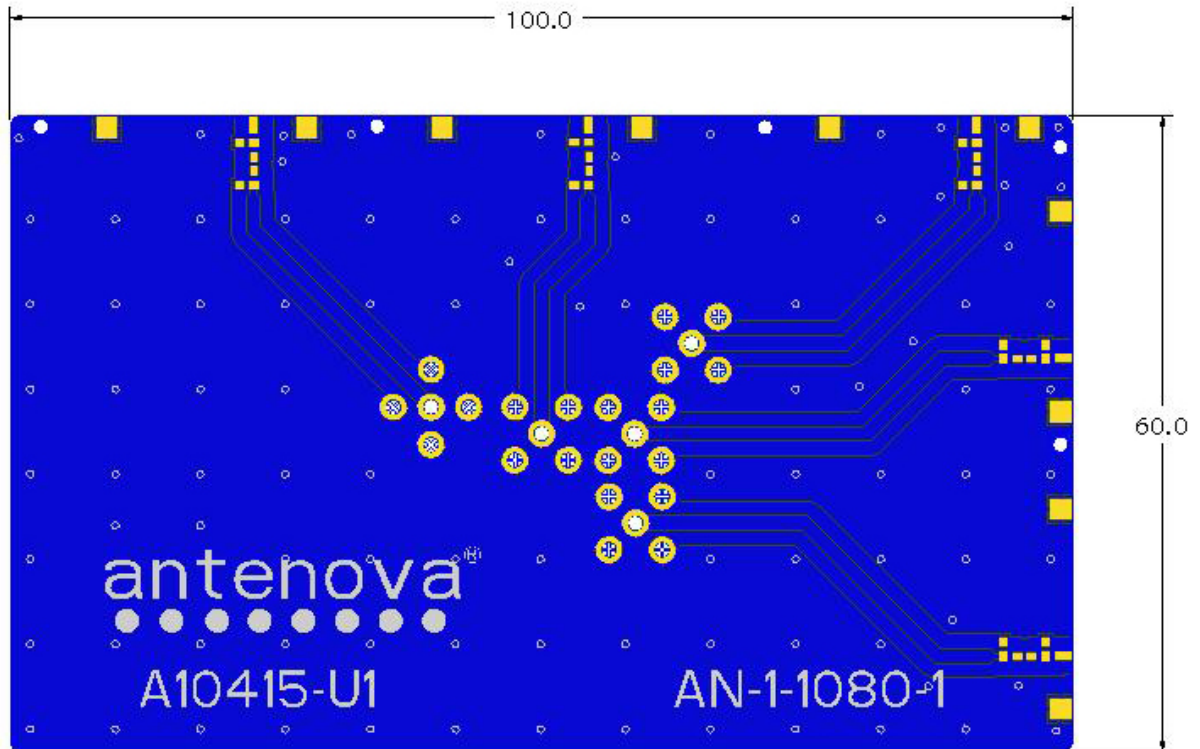

A10415-U1

Dimensions in mm

Contact [info@antenna.com](mailto:info@antenna.com) for further details

## 11 Soldering

The antenna is designed for hand-soldering; reflow soldering must not be used as it could damage the antenna.

This antenna is suitable for lead free soldering.

## 12 Hazardous material regulation conformance

The antenna has been tested to conform to RoHS requirements. A certificate of conformance is available from Antenova's website.

## 13 Packaging

### 13-1 Optimal storage conditions for packaged trays

<b>Temperature</b>	-10°C to 40°C
<b>Humidity</b>	Less than 75% RH
<b>Shelf Life</b>	18 Months
<b>Storage place</b>	Away from corrosive gas and direct sunlight
<b>Packaging</b>	Trays should be stored in unopened sealed manufacturer's boxes.

13-2 Tray characteristics

Acuta

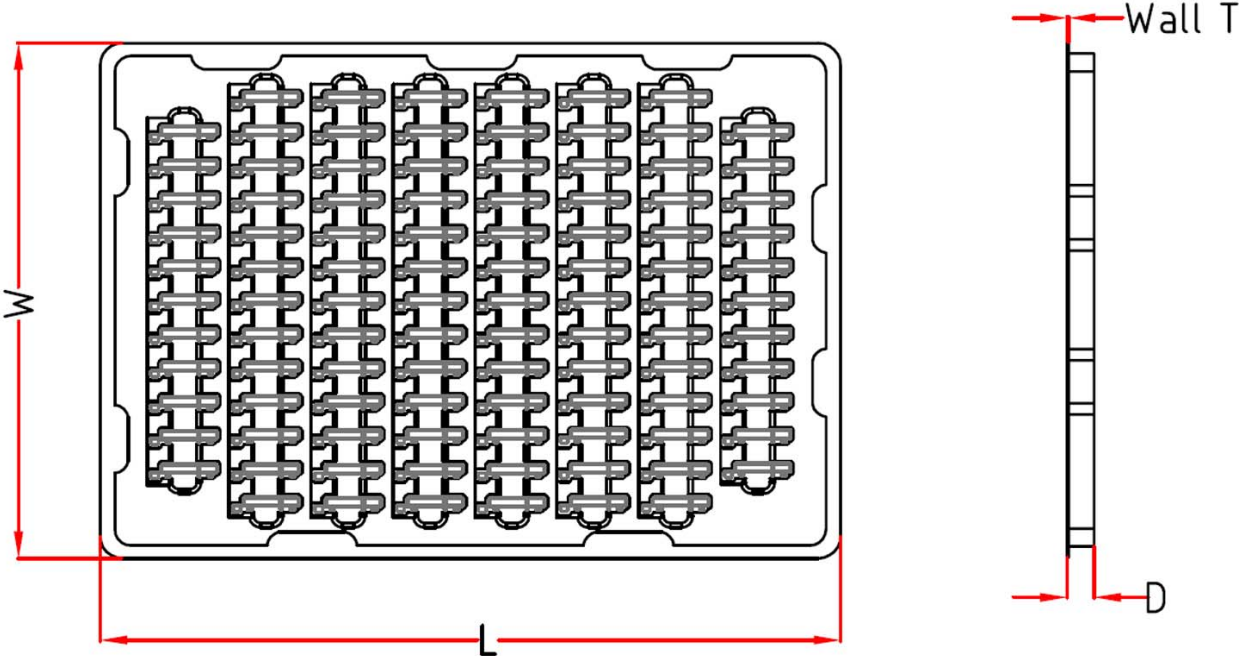

LT	WT	DT	Wall T	Quantity
330 ± 2.0	229 ± 2.0	12 ± 1.0	0.7 ± 0.1	100 pcs/tray

Dimensions in mm



**13-3 Box dimensions**

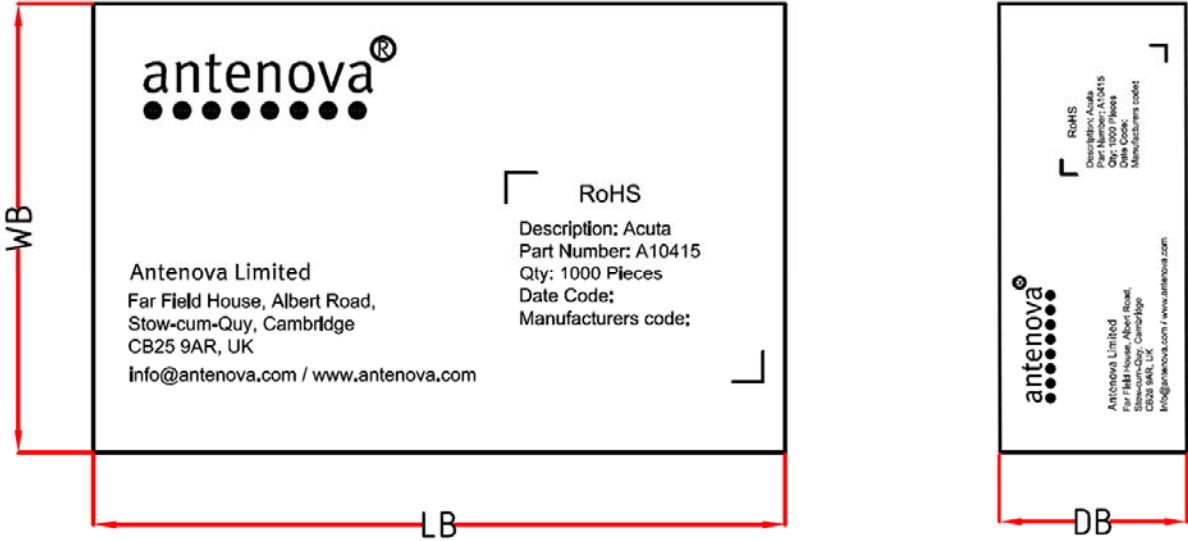

LB	WB	DB	Quantity
370	240	100	1000 pcs/box

Dimensions in mm



**[www.antenova.com](http://www.antenova.com)**

**Corporate Headquarters**

Antenova Ltd.  
Far Field House  
Albert Road  
Stow-cum-Quy  
Cambridge  
CB25 9AR

**Tel:** +44 1223 810600  
**Fax:** +44 1223 810650  
**Email:** [info@antenova.com](mailto:info@antenova.com)

**North America Headquarters**

Antenova Ltd.  
Rogers Business Park  
2541 Technology Drive Suite 403  
Elgin, IL 60124

**Tel:** +1 (847) 551 9710  
**Fax:** +1 (847) 551 9719  
**Email:** [info@antenova.com](mailto:info@antenova.com)

**Asia Headquarters**

Antenova Asia Ltd.  
4F, No. 324, Sec. 1, Nei-Hu Road  
Nei-Hu District  
Taipei 11493  
Taiwan, ROC

**Tel:** +886 (0) 2 8797 8630  
**Fax:** +886 (0) 2 8797 6890  
**Email:** [info@antenova.com](mailto:info@antenova.com)

**Copyright® 2011 Antenova Ltd.** All Rights Reserved. Antenova® is a trademark of Antenova Ltd. Any other names and/or trademarks belong to their respective companies.

The materials provided herein are believed to be reliable and correct at the time of print. Antenova does not warrant the accuracy or completeness of the information, text, graphics or other items contained within these information. Antenova further assumes no responsibility for the use of this information, and all such information shall be entirely at the user's risk.



Certificate No: 4598

**Integrated Antenna and RF Solutions**