

阅读申明

- 1.本站收集的数据手册和产品资料都来自互联网，版权归原作者所有。如读者和版权方有任何异议请及时告之，我们将妥善解决。
- 2.本站提供的中文数据手册是英文数据手册的中文翻译，其目的是协助用户阅读，该译文无法自动跟随原稿更新，同时也可能存在翻译上的不当。建议读者以英文原稿为参考以便获得更精准的信息。
- 3.本站提供的产品资料，来自厂商的技术支持或者使用者的心得体会等，其内容可能存在描述上的差异，建议读者做出适当判断。
- 4.如需与我们联系，请发邮件到marketing@iczoom.com，主题请标有“数据手册”字样。

Read Statement

1. The datasheets and other product information on the site are all from network reference or other public materials, and the copyright belongs to the original author and original published source. If readers and copyright owners have any objections, please contact us and we will deal with it in a timely manner.
2. The Chinese datasheets provided on the website is a Chinese translation of the English datasheets. Its purpose is for reader's learning exchange only and do not involve commercial purposes. The translation cannot be automatically updated with the original manuscript, and there may also be improper translations. Readers are advised to use the English manuscript as a reference for more accurate information.
3. All product information provided on the website refer to solutions from manufacturers' technical support or users the contents may have differences in description, and readers are advised to take the original article as the standard.
4. If you have any questions, please contact us at marketing@iczoom.com and mark the subject with "Datasheets" .

SMT GaAs MMIC x2 ACTIVE FREQUENCY MULTIPLIER, 27 - 31 GHz OUTPUT

Typical Applications

The HMC449LC3B is suitable for:

- Point-to-Point & Multi-Point Radios
- VSAT Radios
- Military EW, ECM, C³I
- Test Instrumentation
- Military & Space

Functional Diagram

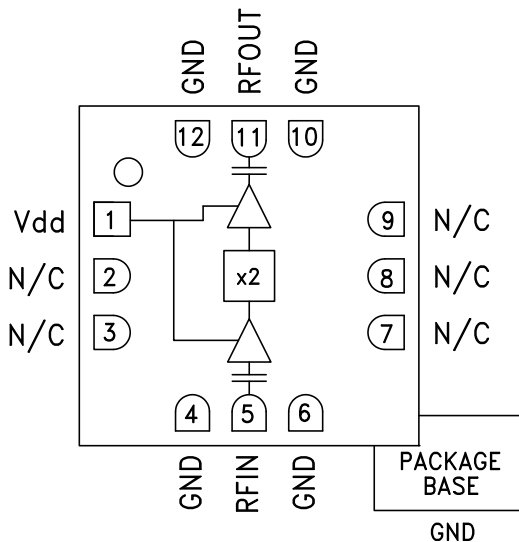

Features

- Output Power: +9 dBm
- Wide Input Power Range: -4 to +6 dBm
- Fo Isolation: 30 dBc @ Fout= 28 GHz
- 100 kHz SSB Phase Noise: -132 dBc/Hz
- Single Supply: 5V@ 50 mA
- RoHS Compliant 3x3 mm SMT Package

General Description

The HMC449LC3B is a x2 active broadband frequency multiplier utilizing GaAs PHEMT technology in a leadless RoHS SMT package. When driven by a 0 dBm signal the multiplier provides +9 dBm typical output power from 27 to 31 GHz. The Fo and 3Fo isolations are >25 dBc and >30 dBc respectively at 30 GHz. The HMC449LC3B is ideal for use in LO multiplier chains yielding a reduced parts count vs. traditional approaches. The low additive SSB Phase Noise of -132 dBc/Hz at 100 kHz offset helps maintain good system noise performance. The HMC449LC3B eliminates the need for wire bonding, allowing the use of surface mount manufacturing techniques.

Electrical Specifications, $T_A = +25^\circ C$, $V_{dd} = +5V$, 0 dBm Drive Level

Parameter	Min.	Typ.	Max.	Units
Frequency Range, Input		13.5 - 15.5		GHz
Frequency Range, Output		27 - 31		GHz
Output Power	5	9		dBm
Fo Isolation (with respect to output level)		30		dBc
3Fo Isolation (with respect to output level)		25		dBc
Input Return Loss		12		dB
Output Return Loss		8		dB
SSB Phase Noise (100 kHz Offset)		-132		dBc/Hz
Supply Current (I _{dd})		50		mA



SMT GaAs MMIC x2 ACTIVE FREQUENCY MULTIPLIER, 27 - 31 GHz OUTPUT

Output Power vs. Temperature @ 0 dBm Drive Level

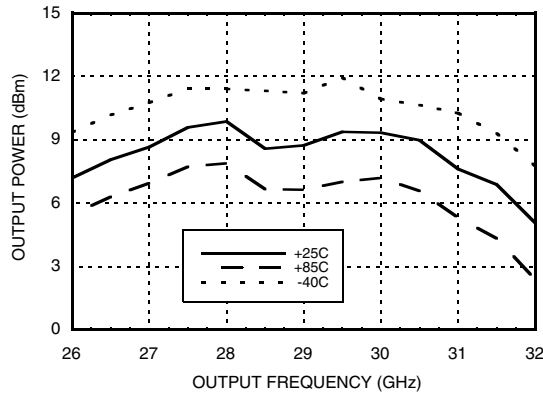

Output Power vs. Drive Level

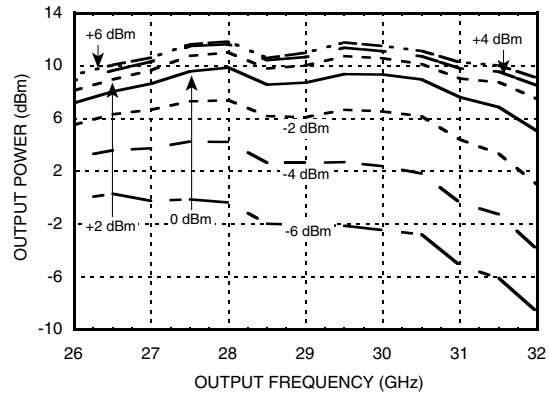

Output Power vs. Supply Voltage @ 0 dBm Drive Level

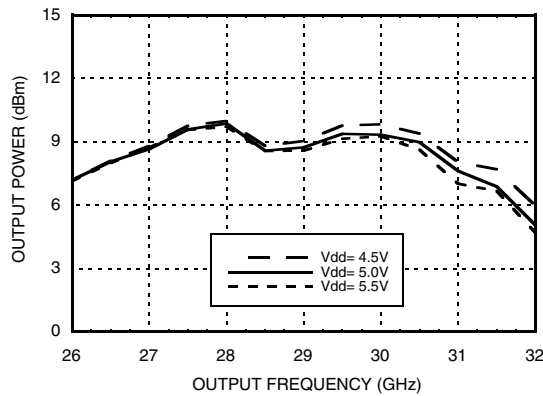

Isolation @ 0 dBm Drive Level

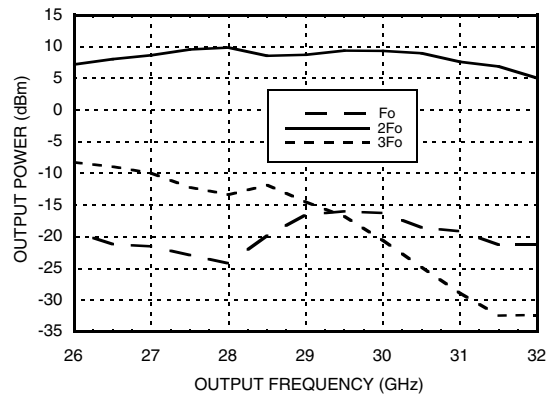

Pin vs. Pout @ 3 Frequencies

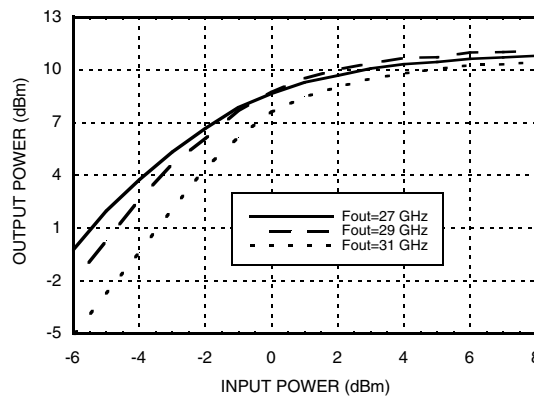

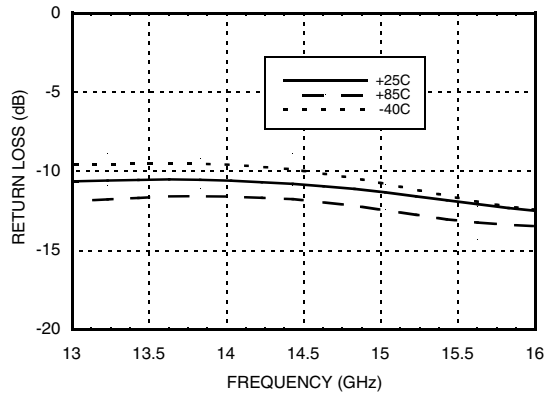
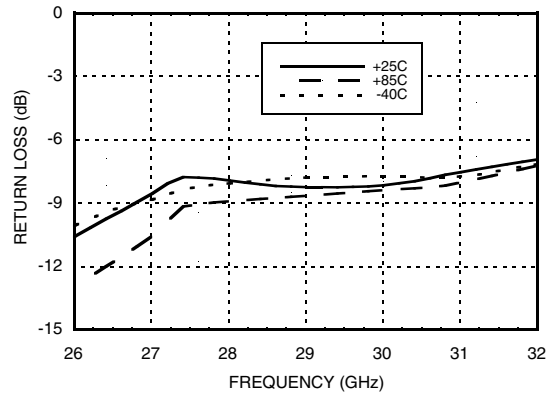
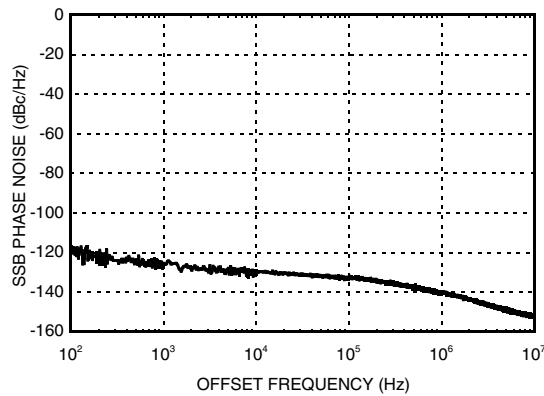
SMT GaAs MMIC x2 ACTIVE FREQUENCY MULTIPLIER, 27 - 31 GHz OUTPUT
Input Return Loss vs. Temperature

Output Return Loss vs. Temperature

**SSB Phase Noise Performance,
Fout = 27 GHz, Pin = 0 dBm**

SMT GaAs MMIC x2 ACTIVE FREQUENCY MULTIPLIER, 27 - 31 GHz OUTPUT

Absolute Maximum Ratings

RF Input (Vcc= +5V)	+20 dBm
Supply Voltage (Vdd)	+6.0 Vdc
Channel Temperature	175 °C
Continuous Pdiss (T= 85 °C) (derate 8.3 mW/°C above 85 °C)	744 mW
Thermal Resistance (channel to ground paddle)	121 °C/W
Storage Temperature	-65 to +150 °C
Operating Temperature	-40 to +85 °C

Typical Supply Current vs. Vdd

Vdd (Vdc)	Idd (mA)
4.5	49
5.0	50
5.5	51

Note:
Multiplier will operate over full voltage range shown above.



ELECTROSTATIC SENSITIVE DEVICE
OBSERVE HANDLING PRECAUTIONS

Outline Drawing

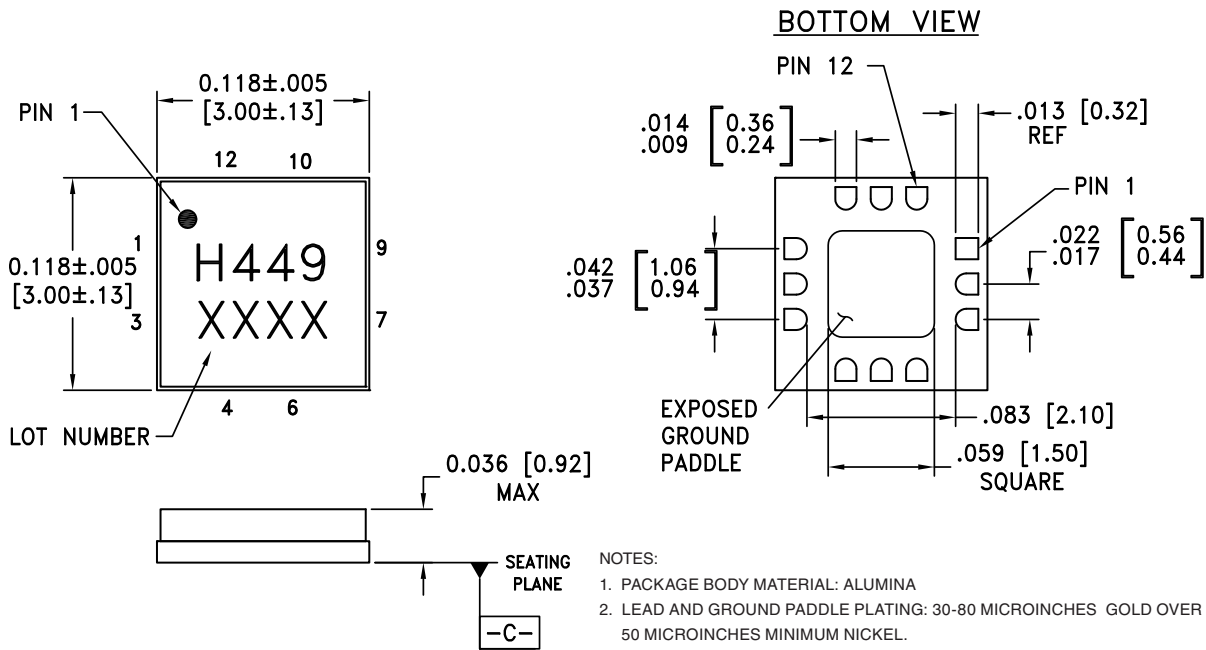



Package Information

Part Number	Package Body Material	Lead Finish	MSL Rating	Package Marking ^[2]
HMC449LC3B	Alumina, White	Gold over Nickel	MSL3 ^[1]	H449 XXXX

[1] Max peak reflow temperature of 260 °C

[2] 4-Digit lot number XXXX

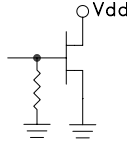
SMT GaAs MMIC x2 ACTIVE FREQUENCY MULTIPLIER, 27 - 31 GHz OUTPUT
Pin Description

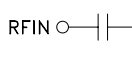
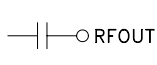
Pin Number	Function	Description	Interface Schematic
1	Vdd	Supply voltage $5V \pm 0.5V$. External bypass capacitors of 100 pF, 1,000 pF and 2.2 μF are required.	
2, 3, 7-9	N/C	This pin may be connected to RF/DC ground. Performance will not be affected.	
4, 6, 10, 12	GND	Package bottom must also be connected to RF/DC ground.	
5	RFIN	Pin is AC coupled and matched to 50 Ohm from 13.5 - 15.5 GHz.	
11	RFOUT	Pin is AC coupled and matched to 50 Ohm from 27 - 31 GHz.	

Application Circuit

Component	Value
C1	100 pF
C2	1,000 pF
C3	2.2 μF

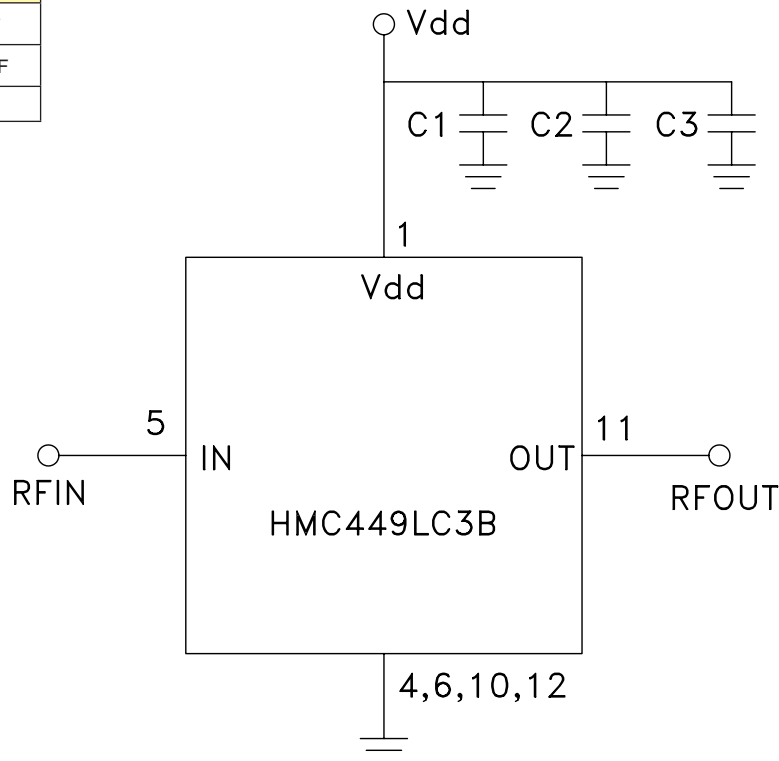



SMT GaAs MMIC x2 ACTIVE FREQUENCY MULTIPLIER, 27 - 31 GHz OUTPUT

Evaluation PCB

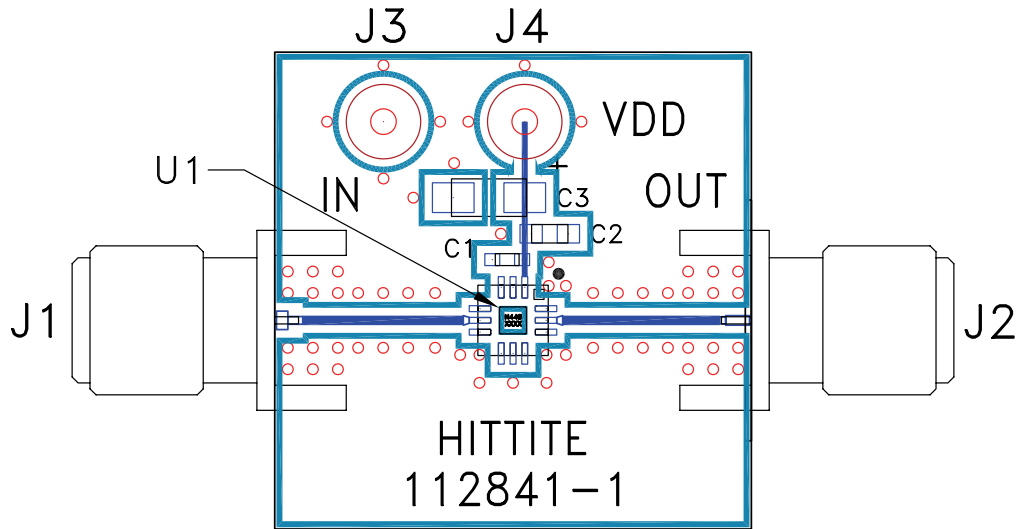

List of Materials for Evaluation PCB 112697 [1]

Item	Description
J1	PCB Mount SRI SMA Connector
J2	PCB Mount SRI K Connector
J3 - J4	DC Pin
C1	100 pF Capacitor, 0402 Pkg.
C2	1,000 pF Capacitor, 0603 Pkg.
C3	2.2µF Tantalum Capacitor
U1	HMC449LC3B x2 Active Multiplier
PCB [2]	112841 Eval Board

[1] Reference this number when ordering complete evaluation PCB

[2] Circuit Board Material: Rogers 4350

The circuit board used in the final application should be generated with proper RF circuit design techniques. Signal lines should have 50 ohm impedance while the package ground leads and exposed paddle should be connected directly to the ground plane similar to that shown. The evaluation circuit board shown is available from Hittite upon request.