

阅读申明

- 1.本站收集的数据手册和产品资料都来自互联网，版权归原作者所有。如读者和版权方有任何异议请及时告之，我们将妥善解决。
- 2.本站提供的中文数据手册是英文数据手册的中文翻译，其目的是协助用户阅读，该译文无法自动跟随原稿更新，同时也可能存在翻译上的不当。建议读者以英文原稿为参考以便获得更精准的信息。
- 3.本站提供的产品资料，来自厂商的技术支持或者使用者的心得体会等，其内容可能存在描述上的差异，建议读者做出适当判断。
- 4.如需与我们联系，请发邮件到marketing@iczoom.com，主题请标有“数据手册”字样。

Read Statement

1. The datasheets and other product information on the site are all from network reference or other public materials, and the copyright belongs to the original author and original published source. If readers and copyright owners have any objections, please contact us and we will deal with it in a timely manner.
2. The Chinese datasheets provided on the website is a Chinese translation of the English datasheets. Its purpose is for reader's learning exchange only and do not involve commercial purposes. The translation cannot be automatically updated with the original manuscript, and there may also be improper translations. Readers are advised to use the English manuscript as a reference for more accurate information.
3. All product information provided on the website refer to solutions from manufacturers' technical support or users the contents may have differences in description, and readers are advised to take the original article as the standard.
4. If you have any questions, please contact us at marketing@iczoom.com and mark the subject with "Datasheets" .

0

T R A N S C E I V E R

3

4

2

B

Z

AEROCOMM'S MOTTO OF "INSTANT WIRELESS" EXPRESSES OUR COMMITMENT TO FACILITATING FAST AND EASY RF INTEGRATION. OUR COMPREHENSIVE DEVELOPMENT TOOLS AND ENGINEERING SUPPORT HELP OEMS ACCELERATE TIME-TO-MARKET.



U S E R
M A N U A L
VERSION 2.0



Technical Support:

Phone: 800.492.2320

E-mail: wireless.support@lairdtech.com

Web: www.aerocomm.com/

Sales:

Phone: 800.492.2320

E-mail: wireless.sales@lairdtech.com

Web: www.aerocomm.com

Document Information

Copyright © 2008 AeroComm, Inc. All rights reserved.

The information contained in this manual and the accompanying software programs are copyrighted and all rights are reserved by AeroComm, Inc. AeroComm, Inc. reserves the right to make periodic modifications of this product without obligation to notify any person or entity of such revision. Copying, duplicating, selling, or otherwise distributing any part of this product or accompanying documentation/software without the prior consent of an authorized representative of AeroComm, Inc. is strictly prohibited.

All brands and product names in this publication are registered trademarks or trademarks of their respective holders.

This material is preliminary

Information furnished by AeroComm in this specification is believed to be accurate. Devices sold by AeroComm are covered by the warranty and patent indemnification provisions appearing in its Terms of Sale only. AeroComm makes no warranty, express, statutory, and implied or by description, regarding the information set forth herein. AeroComm reserves the right to change specifications at any time and without notice.

AeroComm's products are intended for use in normal commercial and industrial applications. Applications requiring unusual environmental requirements such as military, medical life-support or life-sustaining equipment are specifically not recommended without additional testing for such application.

Limited Warranty, Disclaimer, Limitation of Liability

For a period of one (1) year from the date of purchase by the OEM customer, AeroComm warrants the OEM transceiver against defects in materials and workmanship. AeroComm will not honor this warranty (and this warranty will be automatically void) if there has been any (1) tampering, signs of tampering; 2) repair or attempt to repair by anyone other than an AeroComm authorized technician.

This warranty does not cover and AeroComm will not be liable for, any damage or failure caused by misuse, abuse, acts of God, accidents, electrical irregularity, or other causes beyond AeroComm's control, or claim by other than the original purchaser.

In no event shall AeroComm be responsible or liable for any damages arising: From the use of product; From the loss of use, revenue or profit of the product; or As a result of any event, circumstance, action, or abuse beyond the control of AeroComm, whether such damages be direct, indirect, consequential, special or otherwise and whether such damages are incurred by the person to whom this warranty extends or third party.

If, after inspection, AeroComm determines that there is a defect, AeroComm will repair or replace the OEM transceiver at their discretion. If the product is replaced, it may be a new or refurbished product.

Revision History

<u>Revision</u>	<u>Description</u>
Version 1.0	7/21/06 - Initial Release Version
Version 1.1	7/25/06 - Updated Pin definitions, corrected status request command to display 0x00 as firmware version, updated CC 08, CC 21 and EEPROM byte write commands. Corrected PAN ID EEPROM address to address 0x78. Updated Future Enhancements section.
Version 1.2	9/15/06 - Changed Reset to active Low. Changed pin 20 to Sleep pin and is active Low. Added second mechanical drawing.
Version 1.3	1/18/07 - Corrected Read Temperature command.
Version 1.4	7/6/07 - Internal Release.
Version 1.5	7/17/07 - Added pinout for pluggable module.
Version 1.6	8/24/07 - Added API command set. Added Neighbor, Route, & Radio Table commands. Added Energy scan command. Added NV with soft reset command. Added static network parameters information. Updated Broadcast section. Updated Serial Interface section. Updated Channel Mask section. Added power-down modes. Corrected status request response. Added MAC retries to EEPROM parameter list.
Version 1.7	Corrected Read Channel Command (was CC 02 00; changed to CC 02)
Version 1.8	12/17/07 - Updated Compliancy Information. Added approval for ZB2430-D. Updated Approved Antenna List.
Version 1.9	1/4/08 - Added new EEPROM parameters for firmware version 1.6 - End Device poll rate, Parent Hold Message, End Device Wake Time, End Device Wake Poll rate, Stop Bit Delay, Modify Wake upon RX, Reload Sleep, NV Restore enable/disable, & RS485 DE/RE.
Version 2.0	3/1/08- Updated ZB2430 Features, Updated Current Draw for High Power module, Updated RF Packet Size in RX Data Buffer and CTS, Updated Read Digital Input, Updated Read ADC, Updated Write Digital Output, Removed Discover 16-bit NWK Address command, Added Read Voltage cmd, Added Restore Default cmd, Added End-to-End Retries to EEPROM Parameters Table, Updated CTS On/Off Thresholds, Updated Read Neighbor Table Command

Contents

ZB2430 TRANSCEIVER MODULE 1

- ZB2430 Features 1
- Overview 1

SPECIFICATIONS 2

- Pin Definitions 4

HARDWARE INTERFACE 6

- Pin Definitions 6
 - Generic I/O 6
 - RXD and TXD 6
 - Test/Sleep Int. 6
 - UP_Reset 6
 - Command/Data 6
 - In Range 6
 - RTS Handshaking* 6
 - CTS Handshaking 7
 - Sleep Ind. 7
 - AD In 7

TERMS & DEFINITIONS 8

THEORY OF OPERATION 11

- IEEE 802.15.4 & ZigBee Overview 11
- Creating a Network 12
 - Mesh 12
- Parent/Child Relationship 13
- Network Limitations 14
 - Maximum Network Depth 14
 - Maximum Number of Children per Parent 15
- ZigBee Addressing 15
 - 16-bit Network Address 15
 - 64-bit MAC address 16
 - Mesh Routing (AODV) 16
 - Coordinator Addressing 18
 - Broadcast Transmissions 18

SERIAL INTERFACE 20

- Interface Modes 20
 - Transparent Mode 20
 - API Mode 20
- Serial Interface Baud Rate 21
- Interface Timeout / RF Packet Size 22
- Flow Control 22
 - RXD Data Buffer and CTS 23
 - TXD Data Buffer and RTS 23
- Networking 24
- Power Down Modes 26
 - Cyclic Sleep 26
 - Deep Sleep 26

CONFIGURING THE ZB2430 28

- AT Commands 29
 - On-the-Fly Control Commands 29
- Command Descriptions 31

EEPROM PARAMETERS 37

API OPERATION 41

- API Transmit Packet 41
- API Send Data Complete 41
- API Receive Packet 42

ZB2430 ADDRESSING 43

ADVANCED NETWORK COMMANDS 45

- Read Neighbor Table 45
- Read Route Table 47
- Perform Scan 49
- Read Radio Table 51

DIMENSIONS 53

- ZB2430 Mechanical 53

ORDERING INFORMATION 54

- Product Part Numbers 54

COMPLIANCY INFORMATION 55

- Agency Identification Numbers 55
- Approved antenna List 55
- FCC / IC Requirements for Modular Approval 55
- OEM Equipment Labeling Requirements 56
- Antenna Requirements 56
- Warnings required in OEM Manuals 56
- Channel Warning 56

ZB2430 TRANSCEIVER MODULE

AeroComm's ZB2430 module is based on the IEEE 802.15.4 wireless communication standard and the robust ZigBee networking protocol and is one of the most powerful ZigBee compliant solutions on the market today. The ZB2430 provides OEMs with industry leading 2.4 GHz module performance in low power consumption, easy integration, long range, and superior features and functionality. Requiring no additional FCC licensing in the Americas, OEMs can easily make existing systems wireless with little or no RF expertise.

ZB2430 FEATURES

- Mesh architecture
- Energy harvester compatible
- Retries and Acknowledgements
- Programmable Network Parameters
- Multiple generic I/O
- 250 kbps RF data stream
- Software selectable interface baud rates from 110 bps to 115.2 kbps
- Non-standard baud rates supported
- Low cost, low power and small size ideal for high volume, portable and battery powered applications
- All modules are qualified for Industrial temperatures (-40°C to 80°C)
- Advanced configuration available using AT commands
- Easy to use Configuration & Test Utility software

OVERVIEW

The ZB2430 is a member of AeroComm's FlexRF OEM transceiver family. The ZB2430 is a cost effective, high performance, Direct Sequence Spread Spectrum (DSSS) transceiver; designed for integration into OEM systems operating under FCC part 15.247 regulations for the 2.4 GHz ISM band.

To boost data integrity and security, the ZB2430 uses DSSS technology featuring optional Advanced-Encryption Standards (AES)¹. Fully transparent, these transceivers operate seamlessly in serial cable replacement applications. Communications include both system and configuration data via an asynchronous serial interface for OEM Host communications. All association and RF system data transmission/reception is performed by the transceiver.

This document contains information about the hardware and software interface between an AeroComm ZB2430 transceiver and an OEM Host. Information includes the theory of operation, specifications, interface definitions, configuration information and mechanical drawings.

Note: Unless mentioned specifically by name, the ZB2430 modules will be referred to as "radio" or "transceiver". Individual naming is used to differentiate product specific features. The host (PC/Microcontroller/Any device to which the ZB2430 module is connected) will be referred to as "OEM Host" or "Host."

1.Feature not available at the time of this release.

SPECIFICATIONS

Table 1: ZB2430 Specifications

General																
Interface Connector	SMT or Pluggable															
Antenna	Chip antenna (p/n Laird MAF95029) or U.FL connector															
Serial Interface Data Rate	Baud rates from 110 bps to 115,200 bps. Non-standard baud rates are also supported.															
Channels	ZB2430-D: 15 Direct Sequence Channels ZB2430-Q: 15 Direct Sequence Channels															
Security	Channelization, Network Identification and optional 128-bit AES encryption ¹															
Transceiver																
Frequency Band	2400 - 2483.5 MHz															
Channel Bandwidth	3 MHz															
Channel Spacing	5 MHz															
RF Data Rate (Raw)	250 kbps															
Max Throughput	64kbps															
RF Technology	Direct Sequence Spread Spectrum															
Modulation	0-QPSK															
Output Power EIRP (2dBi gain antenna)	ZB2430-D: -12 dBm to +5 dBm ZB2430-Q : +2 dBm to +20 dBm															
Supply Voltage	3.0 - 3.5V, ±50mV ripple															
Current Draw (mA)	<table border="1"> <thead> <tr> <th></th> <th>100% TX</th> <th>100% RX</th> <th>Cyclic Sleep</th> <th>Deep Sleep</th> </tr> </thead> <tbody> <tr> <td>ZB2430-D:</td> <td>25 mA</td> <td>27 mA</td> <td>0.5 uA</td> <td>0.5 uA</td> </tr> <tr> <td>ZB2430-Q:</td> <td>140 mA</td> <td>44 mA</td> <td>7.6 uA</td> <td>7.6 uA</td> </tr> </tbody> </table>		100% TX	100% RX	Cyclic Sleep	Deep Sleep	ZB2430-D:	25 mA	27 mA	0.5 uA	0.5 uA	ZB2430-Q:	140 mA	44 mA	7.6 uA	7.6 uA
	100% TX	100% RX	Cyclic Sleep	Deep Sleep												
ZB2430-D:	25 mA	27 mA	0.5 uA	0.5 uA												
ZB2430-Q:	140 mA	44 mA	7.6 uA	7.6 uA												
Note: Power down modes are <u>not</u> supported on Coordinator & Router devices.																
Sensitivity (1% PER)	ZB2430-D:-90 dBm typical ZB2430-Q:-100 dBm typical															
Range, Line of Site (based on 2dBi gain antenna)	ZB2430-D: Up to 440 ft. ZB2430-Q: Up to 440 ft. at +2 dBm / Up to 3.5 miles at +20 dBm															
Environmental																
Temperature (Operating)	-40°C to 85°C															
Temperature (Storage)	-50°C to +85°C															
Physical																
Dimensions	1.0" x 1.35" x 0.22" (25.4 x 34.3 x 5.5 mm)															

Table 1: ZB2430 Specifications

Certifications	
FCC Part 15.247	ZB2430-D: KQL-ZB2430D ZB2430-Q:KQL-ZB2430-100
Industry Canada (IC)	ZB2430-D: 2268C-ZB2430D ZB2430-Q:2268C-ZB2430
CE	ZB2430-D:Approved ZB2430-Q:Pending

1. Feature not available at the time of this release.

PIN DEFINITIONS

The ZB2430 has a simple interface that allows OEM Host communications with the transceiver. Table 2 below shows the connector pin numbers and associated functions.

Table 2: Pin Definitions for the ZB2430 transceiver

SMT Pin	Pluggable Pin	Type	Signal Name	Function
1	4	O	GIO_0	Generic Output Pin
2	6	O	GIO_1	Generic Output Pin
3	8		Do not Connect	Has internal connection, for AeroComm use only.
4	7	I	GIO_2/ DE-RE	Generic Input pin
5	19	I	GIO_3 / AD_0	Has Internal connection. Reserved for future GPIO.
6	3	I	RXD	Asynchronous serial data input to transceiver
7	2	O	TXD	Asynchronous serial data output from transceiver
8	10	GND	GND	Signal Ground
9	1	PWR	VCC	3.0 - 3.5 V \pm 50mV ripple (must be connected)
10	-	PWR	VPA	3.0 - 3.5 V \pm 50mV ripple (must be connected) ¹
11	-	GND	GND	Signal Ground
12	9	I	<u>Test / Sleep Int.</u>	<p>Test Mode – When pulled logic Low and then applying power or resetting, the transceiver’s serial interface is forced to a 9600, 8-N-1 rate. To exit Test mode, the transceiver must be reset or power-cycled with Test Mode pulled logic High or disconnected</p> <p>Note: Because this mode disables some modes of operation, it should <u>not</u> be permanently pulled Low during normal operation.</p> <p>Sleep mode interrupt - When logic Low, forces End Device to wake up from sleep mode. When logic High, allows End Device to sleep and wake-up according to specified poll rate. Sleep mode interrupt function available on End Devices only.</p>
13	18	I/O	GIO_4 / AD_1	Has Internal connection. Reserved for future GPIO.
14	5	I	<u>UP_Reset</u>	RESET – Controlled by the ZB2430 for power-on reset if left unconnected. After a stable power-on reset, a logic Low pulse will reset the transceiver.
15	11	I	<u>CMD/Data</u>	When logic Low, the transceiver interprets OEM Host data as command data. When logic High or floating, the transceiver interprets OEM Host data as transmit data.
16	20	O	<u>In Range</u>	When logic Low, the transceiver is associated with a parent and has been assigned a 16-bit Network Address. The Coordinator will report In Range after selecting a clear channel to operate.
17	16	I	<u>RTS</u>	Request to Send – When enabled in EEPROM, the OEM Host can take this <u>High</u> when it is not ready to accept data from the transceiver. NOTE: Keeping RTS High for too long can cause data loss due to buffer overflow. ²

Table 2: Pin Definitions for the ZB2430 transceiver

SMT Pin	Pluggable Pin	Type	Signal Name	Function
18	12	O	$\overline{\text{CTS}}$	Clear to Send - Active Low when the transceiver is ready to accept data for transmission. High when input buffer is filling. Continuing to send data when CTS is high can cause buffer overflow and the loss of data.
19	14	I/O	GIO_8 / AD_5	Has Internal connection. Reserved for future GPIO.
20	13	O	$\overline{\text{Sleep Ind.}}$	Sleep mode indicator. When logic Low, transceiver is in sleep mode. When logic High, transceiver is awake.
21	17	I/O	GIO_6 / AD_3	Has Internal connection. Reserved for future GPIO.
22	15	I	GIO_7 / AD_4	Has Internal connection. Reserved for future GPIO.

1. May be left disconnected on ZB2430-D devices.
2. Feature not implemented at time of release.



ENGINEER'S TIP

Design Notes:

- All I/O is 3.3V TTL.
- All inputs are weakly pulled High (20k) and may be left floating during normal operation. When implemented, $\overline{\text{RTS}}$ will be weakly pulled Low.
- Minimum Connections: VCC, VPA, GND, TXD, & RXD.
- Signal direction is with respect to the transceiver.
- Unused pins should be left disconnected.

HARDWARE INTERFACE

PIN DEFINITIONS

Generic I/O

Both GIn and GOn pins serve as generic input/output pins. Reading and writing of these pins can be performed on-the-fly using CC Commands.

RXD and TXD

The ZB2430 accepts 3.3 VDC TTL level asynchronous serial data from the OEM Host via the RXD pin. Data is sent from the transceiver, at 3.3V levels, to the OEM Host via the TXD pin.

Test/Sleep Int.

Test Mode - When pulled logic Low before applying power or resetting, the transceiver's serial interface is forced to 9600, 8-N-1 (8 data bits, No parity, 1 stop bit): regardless of actual EEPROM setting. The interface timeout is also set to 3 ms and the RF packet size is set to the default size of 0x54 (84 bytes). To exit, the transceiver must be reset or power-cycled with $\overline{\text{Test}}$ pin logic High or disconnected.

Note: Because this pin disables some modes of operation, it should not be permanently pulled Low during normal operation.

Sleep Mode Interrupt - When logic Low, forces End Device to wake up from sleep mode. When logic High, allows End Device to sleep and wake-up according to specified poll rate. **Sleep Mode interrupt function available on End Devices only.**

UP_Reset

UP_Reset provides a direct connection to the reset pin on the ZB2430 microprocessor and is used to force a soft reset. For a valid reset, reset must be asserted Low for an absolute minimum of 250 ns.

Command/Data

When logic High, the transceiver interprets incoming serial data as transmit data to be sent to other transceivers. When logic Low, the transceiver interprets incoming serial data as command data. When logic Low, data packets from the radio will not be transmitted over the RF interface however incoming packets from other radios will still be received.

In Range

The In Range pin will be driven low when the radio is associated with a network. In Range will always be driven low on a Coordinator.

RTS Handshaking*

With RTS mode disabled, the transceiver will send any received data to the OEM Host as soon as it is received. However, some OEM Hosts are not able to accept data from the transceiver all of the time. With RTS enabled, the OEM Host can prevent the transceiver from sending it data by de-asserting RTS (High). Once RTS is re-asserted (Low), the transceiver will send packets to the OEM Host as they are received.

Note: Leaving $\overline{\text{RTS}}$ de-asserted for too long can cause data loss once the transceiver's receive buffer reaches capacity.

*Feature not implemented at time of release.

$\overline{\text{CTS}}$ Handshaking

If the transceiver buffer fills up and more bytes are sent to it before the buffer can be emptied, data loss will occur. The transceiver prevents this loss by deasserting $\overline{\text{CTS}}$ High as the buffer fills up and asserting $\overline{\text{CTS}}$ Low as the buffer is emptied. $\overline{\text{CTS}}$ should be monitored by the Host device and data flow to the radio should be stopped when $\overline{\text{CTS}}$ is High.

$\overline{\text{Sleep Ind.}}$

Sleep Indicator output. $\overline{\text{Sleep Ind.}}$ can be used to determine whether or not the transceiver is sleeping. When logic Low, the transceiver is in sleep mode. When logic High, the transceiver is awake.

AD In

AD In can be used as a cost savings to replace Analog-to-Digital converter hardware with the onboard 12-bit ADC. Reading of this pin can be performed locally using the Read ADC command found in the On-the-Fly Control Command Reference.

TERMS & DEFINITIONS

Ad-Hoc Network: A wireless network composed of communicating devices without preexisting infrastructure. Typically created in a spontaneous manner and is self-organizing and self-maintaining.

Association: The process of joining a ZigBee PAN. A device joins the Network by joining a Coordinator or Router which has previously associated with the Network. Upon joining, the Parent device issues a 16-bit Network Address to the device.

Broadcast: Broadcast packets are sent to multiple radios. The ZB2430 allows several different broadcast types including broadcast to all devices & broadcast to Coordinator & all Routers.

Broadcast jitter: The random delay which is automatically introduced by a device before relaying a broadcast packet to prevent packet collisions.

Channel: The frequency selected for data communications within the PAN. The channel is selected by the Network Coordinator on power-up.

Channel Mask: The Channel Mask is a 32-bit field which specifies the range of allowable channels that the radio has to select from when choosing an RF channel. Valid only when Channel Select mode is enabled in EEPROM.

Clear Channel Assessment: An evaluation of the communication channel prior to a transmission to determine if the channel is currently occupied.

Energy Scan: A sweep of the entire frequency band which reports noise readings on every channel & is also capable of detecting Coordinators and reporting their Channel location.

FFD: Full Function Device. The Network Coordinator & Routers are examples of FFD's.

IEEE 802.15.4: IEEE standard for Low-Power Wireless Personal Area Networks (WPAN's). Specifies the physical interface between ZigBee devices.

MAC Address: A unique 64-bit address assigned to each radio. This address cannot be modified and never changes. It is used by the network to identify the device when assigning 16-bit Network Addresses.

Maximum Network Depth: The maximum number of Routers (hops) that a device can be away from the Coordinator. The current profile limit is 5.

Maximum Number of Routers: The total number of children that can serve as Routers for a Network device. The current profile limit is 6.

Maximum Number of Children: The total number of children that can be associated with a single Network device. The current profile limit is 20; comprising of up to 6 Routers and 14 End Devices.

Mesh Network: An interconnection of nodes where nodes are permitted to transmit data directly to any other node.

Neighbor Table: A table used by the Coordinator and Router(s) to keep track of other devices operating in the same coverage area.

Network Address: The unique 16-bit address assigned to a device upon joining a PAN. This address is used for routing messages between devices and can be different each time a device is powered on. The Network Coordinator will **always** have a Network Address of 0x0000. Note that addresses are not assigned in numerical order.

Operating Channel: The specific frequency selected for data communications. The operating channel is determined by the Coordinator on power-up.

Orphan Device: A device which has lost communication contact with or information about its Parent device.

PAN: Personal Area Network. Includes a Network Coordinator and one or more Routers/End Devices. The Network formation is determined by the Maximum Network Depth, Maximum Number of Routers, and Maximum Number of Children.

PAN ID: Similar to a Network ID. Devices which are operating with different PAN ID's will not be associated to the same network.

Parent/Child: When a device joins the Network, it becomes a child of the device with which it is associated. Similarly, the device with which it associated becomes its parent device. Network devices can have multiple children, but only one parent. End Devices cannot be parents and are always children of the Coordinator or a Router. The Coordinator does not have a parent device.

POS: Personal Operating Space. The area within reception range of a specific device.

Profile: A collection of device descriptions, which together form a cooperative application. Devices utilizing different profiles will only support very basic inter-communications. The ZB2430 uses a private profile as specified by Aerocomm.

RFD: Reduced Function Device. The End Device is an example of an RFD.

Route Discovery: An operation using RREQ and RREP's in which a ZigBee Coordinator or Router discovers a route to a device outside its POS.

Route Reply (RREP): A ZigBee command used to reply to a Route Request command.

Route Request (RREQ): A ZigBee command used to discover paths through the network over which messages may be relayed.

Routing Table: A table in which the Coordinator or Router(s) store information required to participate in the routing of data packets throughout the network. The entire route is not stored, only the first step in the route.

Star Network: A network employing a single, central device through which all communication between devices must pass.

TX Cost: A counter of transmission successes/failures. TX Cost starts at 0x00, increments by one every time a packet fails to be delivered, and decrements by one every time a packet is successfully delivered. TX Cost has a range between 0x00 and 0x04.

Unicast: Unicast packets contain a destination address and are received by a single radio only. Unicast packets are point-to-point and do not include Broadcast packets.

ZigBee Stack: A Network specification based on the IEEE 802.15.4 Standard for Wireless Personal Area Networks (WPANs). The ZB2430 uses the Z-Stack (designed by TI) v.1.4.2 and complies to the ZigBee 2006 specification.

ZigBee Alliance: An association of companies working together to create a low-cost, low power consumption, two-way wireless communications standard (<http://www.zigbee.org>).

THEORY OF OPERATION

IEEE 802.15.4 & ZIGBEE OVERVIEW

The ZB2430 uses the ZigBee protocol stack, a network layer protocol which uses small, low power digital transceivers based on the IEEE 802.15.4 hardware standard. The 802.15.4 standard is a specification for a cost-effective, low data rate (<250 kbps), 2.4 GHz or 868/928 MHz wireless technology designed for personal-area and device-to-device wireless networking.

The IEEE 802.15.4 standard specifies the hardware requirements, including frequency bands, receiver sensitivity, modulation and spreading requirements. The ZigBee layer is the software layer that sits atop the 802.15.4 PHY/MAC layer and performs all packet routing and mesh networking.

There are three device types present in a ZigBee network: Coordinator (Full Function Device), Router (Full Function Device), and End Device (Reduced Function Device). Each network consists of a single Coordinator, optional Router(s), and optional Reduced Function End Device(s).

Coordinator

The Coordinator is responsible for establishing the operating channel and PAN ID for the entire Network. Once the Coordinator has established a Network, it allows Routers and End Devices to join the Network; assigning each device a unique 16-bit Network Address.

The Coordinator is intended to be mains powered (always on).



- One Coordinator per Network
- Establishes Channel and PAN ID
- Responsible for Network formation and maintenance
- Full Function Device
- Packet routing capabilities
- Mains powered (always on)
- Power down modes are not supported
- Network address of 0x0000

Router

Routers are responsible for creating and maintaining Network information and determining the optimal route for a data packet. Routers must first associate with the Network before other devices can join through them.

Routers are intended to be mains powered (always on).



- Multiple Routers can be used
- Allows other Routers/End Devices to join the Network
- Full Function Device
- Packet routing capabilities
- Mains powered (always on)
- Power down modes are not supported
- Unique network address dynamically assigned by parent

End Device

While Coordinators and Routers can communicate with any device type, End Devices can communicate only through their parent device. Ideally the End Devices will be in sleep mode all the time. When they have data to send, they wake up, send the data and then go back to sleep. The Parent (Coordinator/Router) of an End Device should be mains powered to allow it to store data to be sent to the sleeping End Device.



- Multiple End Devices can be used
- No packet routing capabilities
- Can communicate with other devices in the Network through its Parent Device
- Reduced Function Device
- Mains or battery powered
- Power down modes are supported
- Unique network address dynamically assigned by parent

CREATING A NETWORK

The IEEE 802.15.4 MAC provides support for two wireless network topologies: star and mesh. The management of these networks is performed by the ZigBee layer. All devices, regardless of topology, participate in the network using their unique 16-bit address assigned by the Coordinator.

Mesh

The mesh topology allows any Full Function Device (Coordinator or Router) to communicate directly with any other device within its range and to have messages relayed to devices which are out of range via multi-hop routing of messages. While a FFD device can communicate with a Reduced Function Device (RFD), RFD's cannot directly route messages and must have their messages routed by their parent device (Coordinator or Router). ZigBee mesh enables the formation of more complex networks, including ad-hoc, self-organizing, and self-healing structures.

Figure 1 shows a typical ZigBee network architecture.

Figure 1: ZigBee Network Topologies

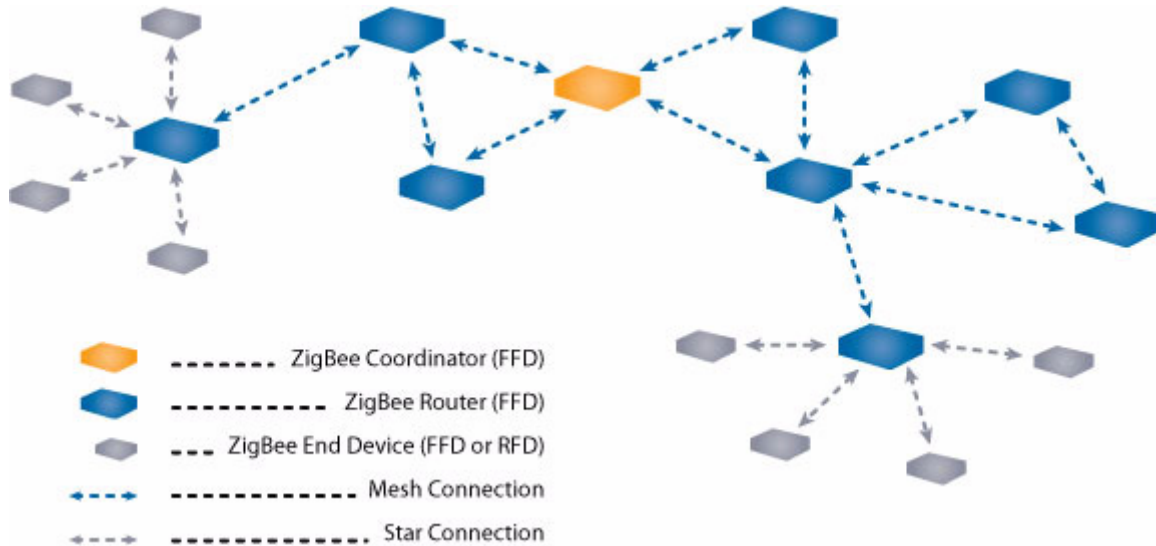

PARENT/CHILD RELATIONSHIP

ZigBee uses a parent/child relationship between network devices. The network begins with the Coordinator as the first device on the network. When a new device (Router or End Device) associates with the Coordinator, it becomes a child of the Coordinator and similarly, the Coordinator becomes a parent of that device. If a second device joins the network, the Coordinator will once again become the parent and the device will become a child of the Coordinator. If a device is not in range of the Coordinator, it subsequently joins the network through a Router, and becomes a child of that Router. Network devices can have multiple children, but only one parent. By design, End Devices cannot be parents and are always children of the Coordinator or a Router.

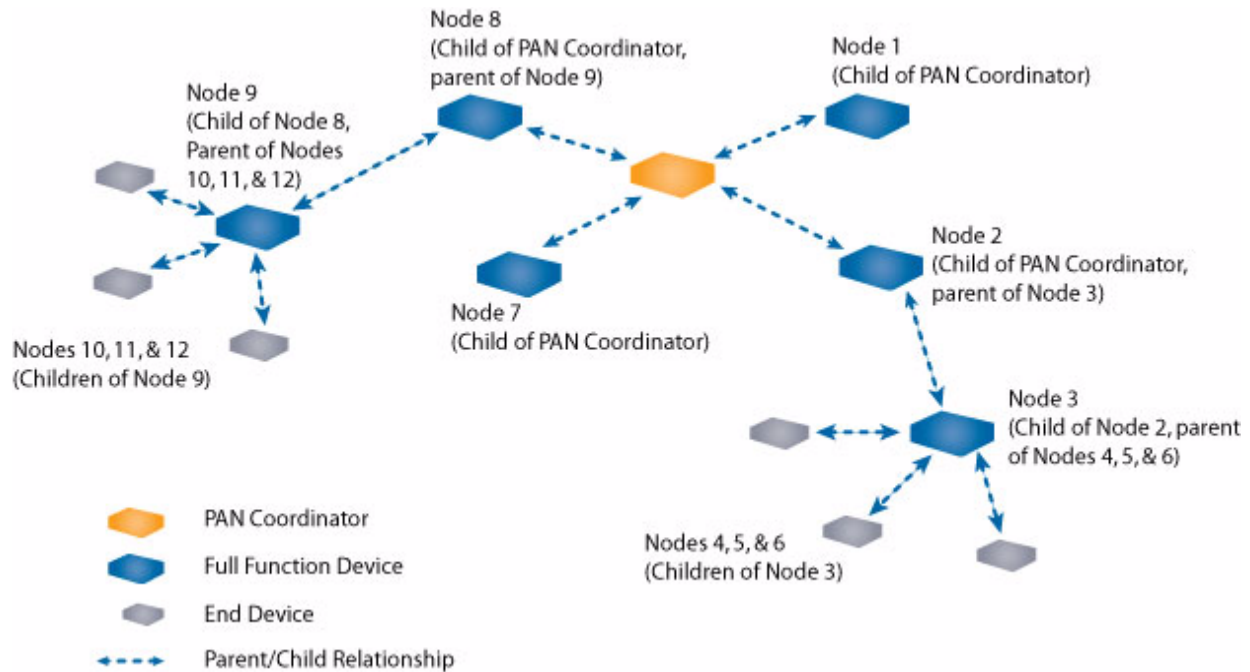
Figure 2: Parent/Child Relationship

NETWORK LIMITATIONS

The ZigBee network structure and ultimate size are specified by Stack profiles. The Stack profiles define the maximum number of Layers, maximum number of Children per Parent, & maximum number of Routers that can be Children. These parameters are set during code compilation and cannot be altered after compilation. The ZB2430 uses the restrictions specified by the Home Lighting & Controls profile.

The ZigBee Coordinator determines the maximum number of children any device within its network is allowed. Of these children, a maximum number can be router-capable devices; while the remainder shall be reserved for end devices. Each device has an associated depth which indicates the minimum number of hops a transmitted packet must travel to reach the ZigBee Coordinator (see Figure 3: "Network Depth" on page 15).

Maximum Network Depth

The Coordinator has a depth of zero and its Children have a depth of 1. Maximum Network Depth specifies the maximum number of hops (Routers) that a node can be away from the Coordinator. The Home Lighting & Controls profile limits the maximum network depth to 5.

Figure 3: Network Depth

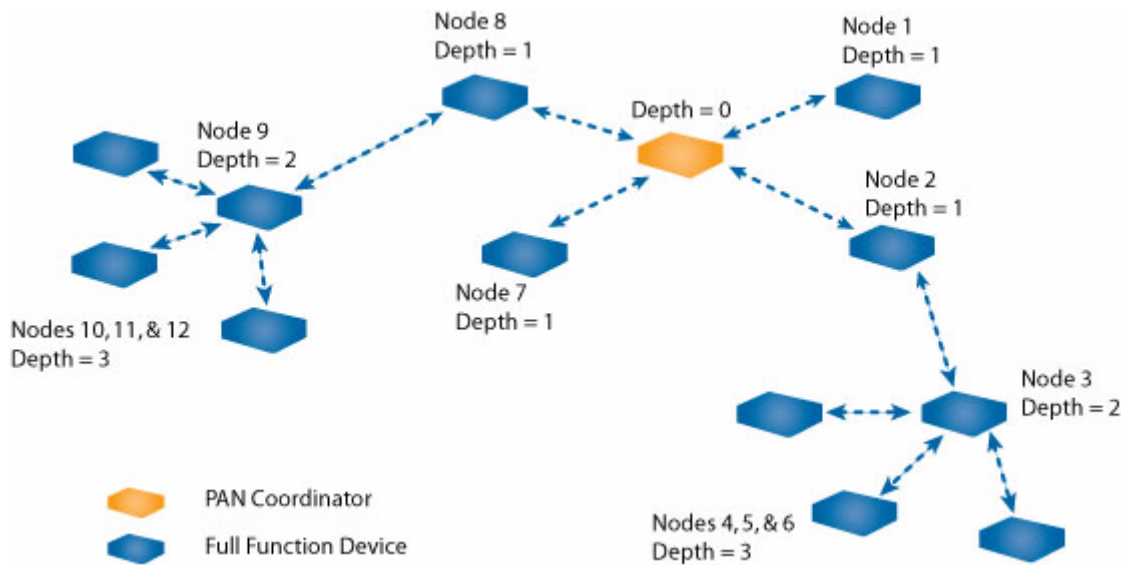

Maximum Number of Children per Parent

The Maximum Number of Children specifies the total number of Children that can be connected directly to a parent device on the current Network. The Home Lighting and Control profile specifies the maximum number of children the Coordinator and Routers can have associated with them to be 20. Of those 20 Children, a maximum of 6 Routers can be router-capable devices while the remainder shall be End Devices.

ZIGBEE ADDRESSING

The IEEE 802.15.4 standard from which the ZigBee protocol was derived specifies two types of addressing modes:

- 16-bit Network Address
- 64-bit MAC Address

16-bit Network Address

The Network Address is a unique address on the network. The Coordinator always has a Network Address of 0x0000 and it will assign a Network Address to each radio within its range. Routers will then assign Network Addresses to radios within their range which have not previously been assigned an address. Because the 16-bit address is unique to each radio on the network, an addressed packet can be sent from any radio on the network to any other radio located anywhere on the network.



ENGINEER'S TIP

16-bit Network Addresses.

In a ZigBee network, nodes are assigned a 16-bit NWK address according to how the network formed. By design, the Coordinator will always have a NWK address of 0x0000. The first Router to that associates with the Coordinator is assigned a NWK address of 0x0001. The second Router that associates with the Coordinator is assigned an address of 0x143E.

The 16-bit address is persistent through power loss and only resets when an NV Reset command is issued performed or NV Restore is disabled in EEPROM (EEPROM address 0x45, bit-3).

64-bit MAC address

The 64-bit MAC address consists of a 40-bit Organizationally Unique Identifier (OUI) and a 24-bit address programmed by the manufacturer. All ZB2430 transceivers have the same OUI of 0x00 0x00 0x00 0x50 0x67 which can be used to distinguish Aerocomm devices on a network but cannot be used to route packets throughout the network.

When a packet needs to be sent to a specific device through the network, the 16-bit network address **must** be used. In order to send data to a specific device in the network, the OEM can compile a table which lists the 64-bit MAC and the corresponding 16-bit Network address (see Table 3 below). The ZB2430's built-in Discover IEEE Address and Discover Network Address commands allow the OEM to query the network and discover all available devices that respond within a fixed period.

Table 3: Device Table Example

Index	MAC Address (64-bit)	NWK Address (16-bit)
0	0x00 0x00 0x00 0x50 0x67 0x12 0x34 0x56	0x0000
1	0x00 0x00 0x00 0x50 0x67 0x16 0x45 0x34	0x0001
2	0x00 0x00 0x00 0x50 0x67 0x34 0x21 0x78	0x143E

Mesh Routing (AODV)

The ZigBee protocol uses the Ad-Hoc On-Demand Distance Vector (AODV) routing algorithm. AODV allows nodes to pass messages through their neighbors to devices which they cannot communicate directly. This is done by discovering the routes along which messages can be passed using the shortest route possible.

Figure 4 below shows a typical ZigBee network. The circles surrounding the 4 nodes represent the Personal Operating Space (POS) of each node. Because of the limited range, each node can only communicate with the neighboring node(s) next to it. When a node needs to send a message to a node which is not a neighbor, it broadcasts a Route Request (RREQ) message containing the Source Destination Address, the Network Address of the Destination radio and a path cost metric.

In the example below, Node 0 needs to send a message to Node 3; however the two are not within communication range of each other. Node 0's neighbors are Node 1 and Node 2. Since Node 0 cannot directly communicate with Node 3, it sends out a RREQ which is heard by Nodes 1 and 2 (see Figure 5: "ZigBee Route Request" on page 17).

Figure 4: ZigBee AODV

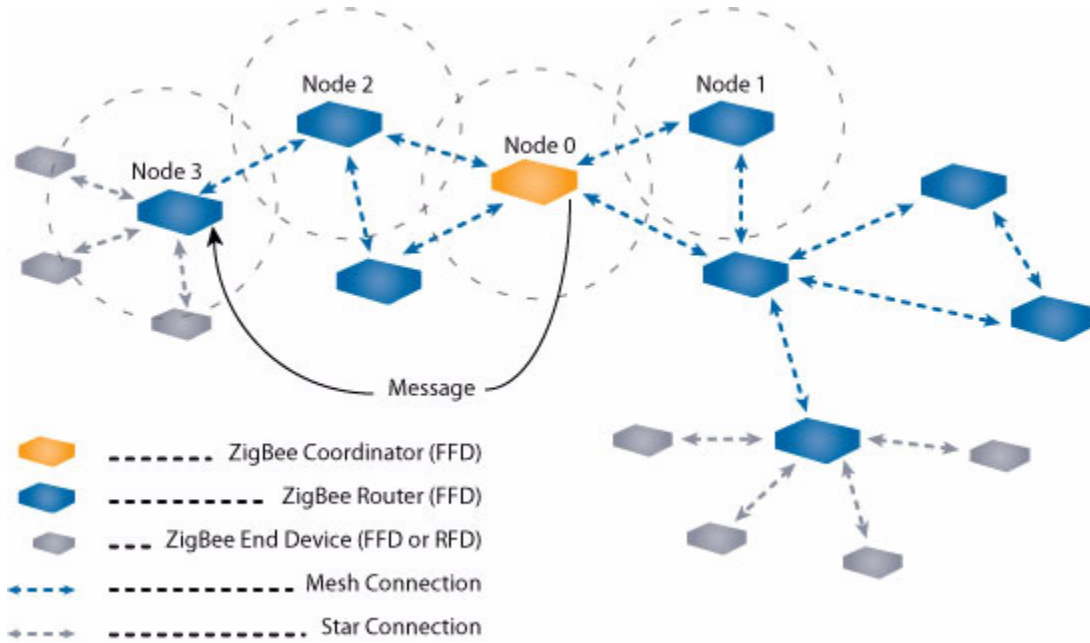
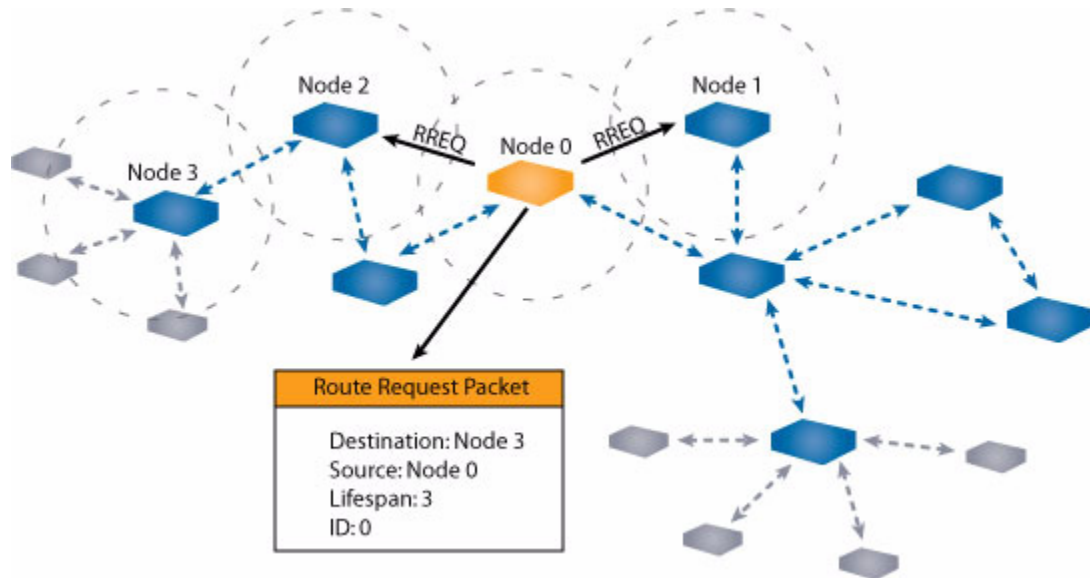

Figure 5: ZigBee Route Request



One of two things will happen when Nodes 1 and 2 receive the RREQ from Node 0:

- If a route is known or if they are the destination radio, they can send a Route Reply (RREP) back to Node 0.
- If they do not know the route and are also not the destination radio, they will rebroadcast the RREQ to their neighbors. The message keeps re-broadcasting until the lifespan (specified by the source radio) expires.

If Node 0 does not receive a reply within a set amount of time, it will rebroadcast the message, this time with a longer lifespan and a new ID number.

In the example, Node 1 does not have a route to Node 3 and therefore rebroadcasts the RREQ (see Figure 6: "ZigBee Route Reply" on page 18). Node 2 however, does have a route to Node 3 and therefore replies to the RREQ by sending out a RREP. Node 2 also sends a RREP to Node 3 so that it knows the route to Node 0.

Figure 6: ZigBee Route Reply

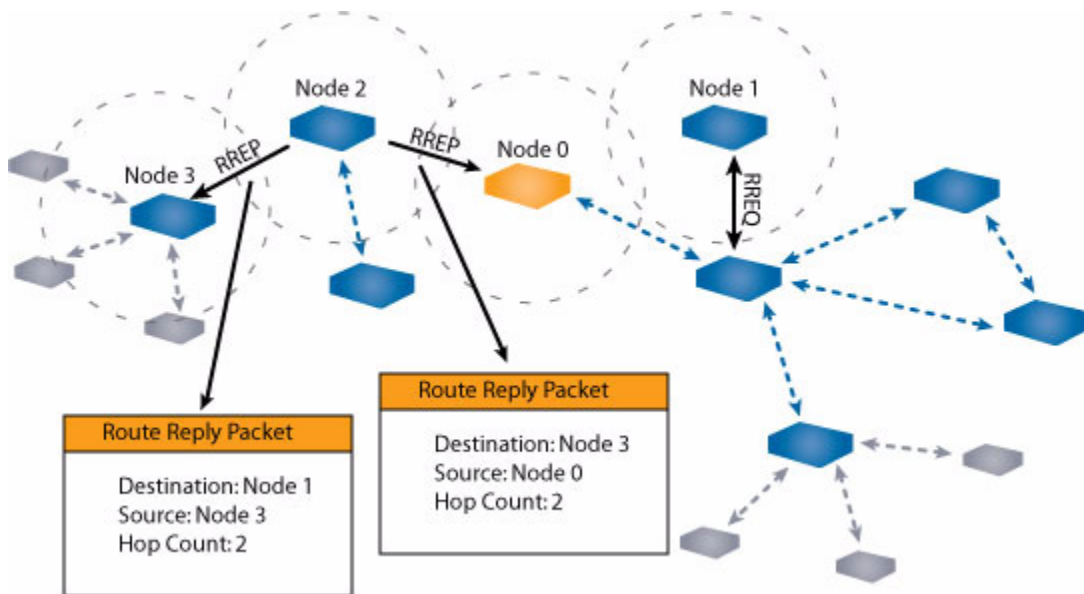

Coordinator Addressing

Since the Coordinator's NWK address is always 0x0000, it can be addressed using its 16-bit NWK address.

Broadcast Transmissions

Since ZigBee is targeted for large-scale applications in which all radios may not be in range of a single radio, broadcast packets are retransmitted throughout the network. Broadcast transmissions in ZigBee utilize a passive acknowledgement mechanism; meaning that the Coordinator and all Routers keep track of whether or not their neighbor(s) have relayed the broadcast packet and will re-broadcast the packet until all of their neighboring devices have received the packet. Any device can initiate a Broadcast transmission by programming its Destination Address with a Broadcast Address (see Table 4 on page 19). Subsequent broadcast transmissions occur every 500ms.

Table 4: Broadcast Addresses

Broadcast Address	Destination Group
0xFFFF	All devices in PAN
0xFFFE	Reserved
0xFFFD	All non-sleeping devices when <i>RXOn-WhenIdle</i> = True
0xFFFC	All Routers and Coordinator
0xFFF8 - 0xFFFB	Reserved

**ENGINEER'S TIP****Sending a Broadcast packet.**

While ZigBee does provide the means for broadcasting data packets throughout the network, because of the inherent delays associated with broadcast transmissions overall latency may increase; especially with larger networks. Because of the added latency and overall effect on the network, broadcast transmissions within a ZigBee network should be limited.

SERIAL INTERFACE

The ZB2430 transceiver module interfaces to the OEM Host via an asynchronous 3.3V serial UART interface; allowing the module to be easily integrated into any 3.3V system without requiring any level translation. The module can communicate with any logic and voltage compatible UART; or to any serial device with an additional level translator.

INTERFACE MODES

The ZB2430 has two different types of interface modes:

- Transparent Mode
- API Mode

Transparent Mode

When operating in Transparent Mode, the ZB2430 can act as a direct serial cable replacement in which received RF data is forwarded over the serial interface and vice versa. Additionally, many parameters can be configured using either AT commands or by toggling the Command/Data pin on the transceiver. In transparent mode, the radio needs to be programmed with the Network Address of the desired recipient. The destination address can be programmed permanently or on-the-fly.

When Transparent Mode is used, data is stored in the TX buffer until one of the following occurs:

- The RF packet size is reached (EEPROM address 0x5A)
- An Interface Timeout occurs (EEPROM address 0x58)

API Mode

API Mode is an alternative to the default Transparent operation of the ZB2430 and provides dynamic packet routing and packet accounting abilities to the OEM Host without requiring extensive programming by the OEM Host. API Mode utilizes specific frame-based packet formats; specifying various vital parameters used to control radio settings and packet routing on a packet-by-packet basis. The API features can be used in any combination that suits the OEM's application specific needs.

API Mode provides an alternative method of configuring modules and message routing at the OEM Host level; without requiring the use of Command Mode. The ZB2430 has three API functions:

- Transmit API
- Receive API
- API Send Data Complete

For additional details and examples, please refer to the API section on page 41.

SERIAL INTERFACE BAUD RATE

In order for the OEM Host and a transceiver to communicate over the serial interface they need to have the same serial data rate. This value determines the baud rate used for communicating over the serial interface to a transceiver. For a baud rate to be valid, the calculated baud rate must be within $\pm 3\%$ of the OEM Host baud rate.

Table 5: Baud Rate / Interface Timeout

Desired Baud Rate	Baud (0x42)	Minium Interface Timeout ¹ (0x58)	Stop Bit Delay (0x3F)
115,200	0x08	0x02	0x02
57,600	0x07	0x02	0x02
38,400 ²	0x06	0x02	0x02
31,250	0x05	0x02	0x02
19,200	0x04	0x02	0x02
9,600	0x03	0x03	0x03
4,800	0x02	0x05	0x05
2,400	0x01	0x09	0x09
1,200	0x00	0x16	0x16
Non-standard	0xE3	Use equations below	Use equations below

1. Interface timeout = 1 ms per increment
2. Default baud rate

For baud rates other than those shown in Table 5 the following equations can be used:

$$\text{Baud Rate} = \frac{(256 + \text{BAUD_M}) \times (2^{\text{BAUD_E}}) \times \text{FREQUENCY}}{2^{28}}$$

Where:

FREQUENCY = 32 MHz

BAUD_M = EEPROM Address 0x43

BAUD_E = EEPROM Address 0x44

$$\text{Minimum Interface Timeout required} = \frac{20}{\text{Baud Rate} \times 1 \text{ms}}$$

$$\text{Stop Bit Delay} = \frac{20}{(\text{Baud Rate} \times 1\text{ms})}$$



ENGINEER'S TIP

Using a non-standard baud rate.

The ZB2430 supports a majority of standard as well as non-standard baud rates. To select a standard baud rate, use the value shown for EEPROM address 0x42 in Table 5 above. To enable a non-standard baud rate, program EEPROM address 0x42 (Custom Baud Enable) to 0xE3 and then use the equation above to solve for BAUD_M and BAUD_E.

INTERFACE TIMEOUT / RF PACKET SIZE

Interface Timeout – Interface Timeout specifies a maximum byte gap between consecutive bytes. When that byte gap is exceeded, the bytes in the transmit buffer are processed as a complete packet. Interface Timeout (EEPROM address 0x58), in conjunction with the RF Packet Size, determines when a buffer of data will be sent out over the RF as a complete RF packet, based on whichever condition occurs first.

RF Packet Size - RF Packet Size is used in conjunction with Interface Timeout to determine when to delineate incoming data as an entire packet based on whichever condition is met first. When the transceiver receives the number of bytes specified by RF Packet Size (EEPROM address 0x5A) without experiencing a byte gap equal to Interface Timeout, that block of data is processed as a complete packet. Every packet the transceiver sends over the RF contains extra header bytes not counted in the RF Packet Size. Therefore, it is much more efficient to send a few large packets than to send many short packets.

Stop Bit Delay - For systems using the RS-485 interface, the RS-485 DE pin might be deasserted Low too quickly at the end of a packet (especially at slower interface baud rates). Stop Bit Delay (EEPROM address 0x3F) controls how long RS-485 DE should be left High at the end of a packet before dropping it Low and disabling the RS-485 driver circuitry. Generally, it should be set greater than or equal to two byte times.

FLOW CONTROL

Although flow control is not required for transceiver operation, it is recommended to achieve optimum system performance and to avoid overrunning the ZB2430's serial buffers. The ZB2430 uses separate buffers for incoming and outgoing data.

RXD Data Buffer and $\overline{\text{CTS}}$

As data is sent from the OEM Host to the radio over the serial interface, it is stored in the ZB2430's buffer until the radio is ready to transmit the data packet. As discussed in "Interface Modes" on page 20, the radio waits to transmit the data until one of the following conditions occur (whichever occurs first):

- The RF packet size is reached (EEPROM address 0x5B)
- An Interface Timeout occurs (EEPROM address 0x58)

After sending the packet over the RF the data continues to be stored in the buffer until the radio receives an RF Acknowledgement (ACK) from the receiving radio (addressed mode), or all transmit retries/broadcast attempts have been utilized. Once an ACK has been received or all retries/attempts have been exhausted, the current data packet is removed from the buffer and the radio will begin processing the next data packet in the buffer.

To prevent the radio's RXD buffer from being overrun, it is strongly recommended that the OEM Host monitor the radio's $\overline{\text{CTS}}$ output. When the number of bytes in the RXD buffer reaches the value specified by CTS_ON (EEPROM address 0x5C), the radio de-asserts (High) $\overline{\text{CTS}}$ to signal to the OEM Host to stop sending data over the serial interface. $\overline{\text{CTS}}$ is re-asserted after the number of bytes in the RXD buffer is reduced to the value specified by CTS_OFF (EEPROM address 0x5D); signalling to the OEM Host that it may resume sending data to the transceiver.

Note: It is recommended that the OEM Host cease all data transmission to the radio while $\overline{\text{CTS}}$ is de-asserted (High); otherwise potential data loss may occur.

TXD Data Buffer and $\overline{\text{RTS}}$

As data to be forwarded to the OEM Host accumulates, it is stored in the ZB2430's outgoing buffer until the radio is ready to begin sending the data to the OEM Host. Once the data packet has been sent to the Host over the serial interface, it will be removed from the buffer and the radio will begin processing the next data packet in the buffer.

With RTS Mode disabled, the transceiver will send any data to the OEM Host as soon as it has data to send. However, some OEM Hosts are not able to accept data from the transceiver all of the time. With RTS Mode Enabled, the OEM Host can prevent the transceiver from sending it a data by de-asserting $\overline{\text{RTS}}$ (High), causing the transceiver to store the data in its buffer. Once $\overline{\text{RTS}}$ is re-asserted (Low), the transceiver will continue sending data to the OEM Host, beginning with any data stored in its buffer.

Note: Leaving $\overline{\text{RTS}}$ de-asserted for too long can cause data loss once the radio's TXD buffer reaches capacity.



ENGINEER'S TIP

Can I implement a design using just TXD, RXD and Gnd (Three-wire Interface)?

Yes. However, it is strongly recommended that your hardware monitor the $\overline{\text{CTS}}$ pin of the radio. $\overline{\text{CTS}}$ is taken High by the radio when its interface buffer is getting full. Your hardware should stop sending at this point to avoid a buffer overrun (and subsequent loss of data).

You can perform a successful design without monitoring $\overline{\text{CTS}}$. However, you need to take into account the amount of latency the radio adds to the system, any additional latency caused by Transmit Retries, how often you send data, non-delivery network timeouts and interface data rate and the size of the packets.

Aerocomm can assist in determining whether $\overline{\text{CTS}}$ is required for your application.

NETWORKING

PAN ID - PAN ID (EEPROM address 0x79) is a 16-bit field and is similar to a password or network number and helps differentiate collocated networks. A transceiver will not be associated with a network unless its PAN ID and Channel Number match that of the Coordinator. Range is 0x0000 to 0x3FFF.

RF Channel Number - (EEPROM Address 0x40) Channels 0x0B - 0x1A; 5 MHz spacing. The transceiver will operate only on the RF Channel Number specified in the EEPROM.

Note: The ZB2430-Q is not approved for use on channel 0x1A and the channel number should therefore be selected accordingly.

Figure 7: IEEE 802.15.4 RF Channels

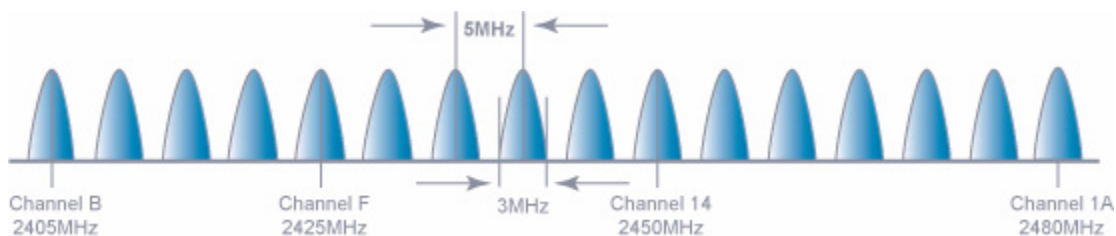

Table 6: RF Channel Number Settings

Radio Model	RF Channel Number Range (0x40)	Frequency Details & Regulatory requirements	Countries
ZB2430-D	0x0B - 0x1A	2400 - 2475 MHz	Pending Approval
ZB2430-Q	0x0B - 0x19	2400 - 2465 MHz	Global

Channel Select - When enabled in EEPROM (EEPROM address 0x56, bit-3) the Coordinator will select a channel permitted by the Channel Mask with the least amount of energy present. The Coordinator will start on the first channel and if RF energy is detected or another network is detected, it will change to the next channel. This continues for all the channels and then the clearest channel is selected.

When a Router is powered on, it will scan each channel; periodically sending beacons and searching for a parent. When the parent receives a beacon from the Router, it sends an acknowledgement to the Router, and the Router is associated with that parent.

When disabled in EEPROM, the Coordinator will use the RF Channel programmed at EEPROM address 0x40 to establish its network.

Channel Mask - The Channel Mask (EEPROM Address 0x30) is a 32-bit field which specifies the range of allowable channels that the radio can select from when choosing an RF channel. In order for two devices to communicate, a common channel must be selected. At least one channel must be selected (set to 1).

To use the Channel Mask, enable Channel Select (EEPROM Address 0x56, bit 3). When Channel Select is enabled, the radio disregards the Channel specified at EEPROM address 0x40. When Channel Select is disabled, only the Channel specified at EEPROM Address 0x40 will be used.

Examples:

The example shown in Figure 8 below enables all 2.4GHz channels for possible use by selecting 0x07FFF800 as the Channel Mask. The Channel Mask enables you to allow all or to exclude specific channels from selection. The example in Figure 9 shows channels 0x14-0x1A as the only available channels to select from. Finally Figure 10 below shows channels 0x0B-0x10 as the only available channels to select from.

Figure 8: Channel Mask - Allow all channels

Reserved	Reserved	Reserved	Reserved	Reserved	2480MHz	2475MHz	2470MHz	2465MHz	2460MHz	2455MHz	2450MHz	2445MHz	2440MHz	2435MHz	2430MHz	2425MHz	2420MHz	2415MHz	2410MHz	2405MHz	Reserved	Reserved	Reserved	Reserved	Reserved	Reserved	Reserved	Reserved	Reserved	Reserved	Reserved	Reserved	Reserved	Reserved
1F	1E	1D	1C	1B	1A	19	18	17	16	15	14	13	12	11	10	F	E	D	C	B	A	9	8	7	6	5	4	3	2	1	0			
32-bit Mask																																		
0	0	0	0	0	1	1	1	1	1	1	1	1	1	1	1	1	1	1	1	1	0	0	0	0	0	0	0	0	0	0	0	0	0	
Binary																																		
				7				F				F				F				8				0				0						
Hex representation																																		

Figure 9: Channel Mask - Allow channels 0x14-0x1A only

Reserved	Reserved	Reserved	Reserved	Reserved	2480MHz	2475MHz	2470MHz	2465MHz	2460MHz	2455MHz	2450MHz	2445MHz	2440MHz	2435MHz	2430MHz	2425MHz	2420MHz	2415MHz	2410MHz	2405MHz	Reserved	Reserved	Reserved	Reserved	Reserved	Reserved	Reserved	Reserved	Reserved	Reserved	Reserved	Reserved	Reserved	Reserved
1F	1E	1D	1C	1B	1A	19	18	17	16	15	14	13	12	11	10	F	E	D	C	B	A	9	8	7	6	5	4	3	2	1	0			
32-bit Mask																																		
0	0	0	0	0	1	1	1	1	1	1	1	0	0	0	0	0	0	0	0	0	0	0	0	0	0	0	0	0	0	0	0	0	0	
Binary																																		
				7				F				0				0				0				0				0						
Hex representation																																		

Figure 10: Allow channels 0x0B-0x10 only

Reserved	Reserved	Reserved	Reserved	Reserved	2480MHz	2475MHz	2470MHz	2465MHz	2460MHz	2455MHz	2450MHz	2445MHz	2440MHz	2435MHz	2430MHz	2425MHz	2420MHz	2415MHz	2410MHz	2405MHz	Reserved	Reserved	Reserved	Reserved	Reserved	Reserved	Reserved	Reserved	Reserved	Reserved	Reserved	Reserved	Reserved	Reserved
1F	1E	1D	1C	1B	1A	19	18	17	16	15	14	13	12	11	10	F	E	D	C	B	A	9	8	7	6	5	4	3	2	1	0			
32-bit Mask																																		
0	0	0	0	0	0	0	0	0	0	0	0	0	0	0	1	1	1	1	1	0	0	0	0	0	0	0	0	0	0	0	0	0	0	
Binary																																		
				0				0				1				F				8				0				0						
Hex representation																																		

Note: When Channel Select is enabled in EEPROM, the initial network synchronization time will increase. Channel Select is disabled in EEPROM by default. All devices on the network should use the same setting for Channel Select.

POWER DOWN MODES

Power down modes allow the ZB2430 to operate at minimum current consumption while not in use. The ZB2430 provides two such modes (End Devices only).

- Cyclic Sleep (Wake periodically based on software-controlled timer or pin interrupt)
- Deep Sleep (Wake on pin interrupt)

In order for a module to transition into Sleep mode, the $\overline{\text{Sleep_Int}}$ pin (pin 12) must be logic High or floating. If this pin is pulled Low, the device will be forced out of Sleep mode and will not be allowed to Sleep until the pin returns to the High state. While in Sleep mode, the module will not transmit/receive data until after waking up.

Table 7: Sleep Mode Settings

Sleep Mode	Transition to Sleep	Transition to Wake	Current Draw (mA)
Cyclic Sleep	Automatic transition to Sleep mode after sending Data Request to Parent Device or Sleep_Int is asserted High. End Device wake time can also be configured in the EEPROM (EEPROM address 0x3B).	Automatic transition to Wake mode occurs after an EEPROM selectable period or manual transition when Sleep_Int is pulled logic Low.	ZB2430: 0.5 uA ZB2430-100: 7.6 uA
Deep Sleep	Automatic transition to Sleep mode occurs after device has successfully associated with Network.	Manual transition to Wake mode occurs after Sleep_Int is pulled logic Low.	ZB2430: 0.5 uA ZB2430-100: 7.6 uA

Cyclic Sleep

In Cyclic Sleep mode the End Device will wake periodically to request data from its Parent device. The rate at which the module wakes up to check for data is adjustable in EEPROM (EEPROM address 0x34, 16-bits) in 1 ms increments with a default setting of 1000ms. The device will wakeup for the period specified by the End Device Wake time (EEPROM address 0x3B), send a data request to its Parent, and then return to sleep until the next cycle.

Note: Setting the sleep rate to 0x0000 forces the module into Deep Sleep mode (see below).

Deep Sleep

Deep sleep mode is a power-down mode in which the ZB2430 automatically transitions to Sleep mode after having associated with the Network. While in Deep Sleep mode, the device will not wake up until interrupted by the Sleep_Int pin. To wake the device out of Deep Sleep mode, Sleep_Int must be pulled logic Low. The device will return to Deep Sleep mode after Sleep_Int is returned to the High state.



ENGINEER'S TIP

Transmitting and Receiving data with a sleeping End Device.

- Data sent to the radio over the UART while it is sleeping will be lost. If the module wakes while receiving data over the UART, it will only see the data received since waking up.
- Incoming RF packets to the module will not keep it awake unless you enable Modify Wake upon RX in EEPROM (EEPROM address 0x45, bit-5).
- When sending data for the module to transmit, it is recommended that the module be forced awake using the $\overline{\text{Sleep_Int}}$ pin until the module is finished transmitting the data. .
- While the module is being kept awake using the $\overline{\text{Sleep_Int}}$ pin, it will send data requests to its Parent Device based on the Wake Poll rate specified in EEPROM (EEPROM address 0x3C) for as long as it is awake.
- A Parent will only store data for a sleeping End Device for a maximum amount of time specified by the Parent Hold Message EEPROM parameter (EEPROM address 0x39).

CONFIGURING THE ZB2430

The ZB2430 can be configured using the CC Configuration Commands. These commands can be issued using either Hardware or Software Configuration. To use Hardware Configuration, the Command/Data pin of a transceiver must be asserted Low. Software Configuration can be used by entering AT Command Mode before issuing the CC commands.

Figure 11: ZB2430 Configuration Flow

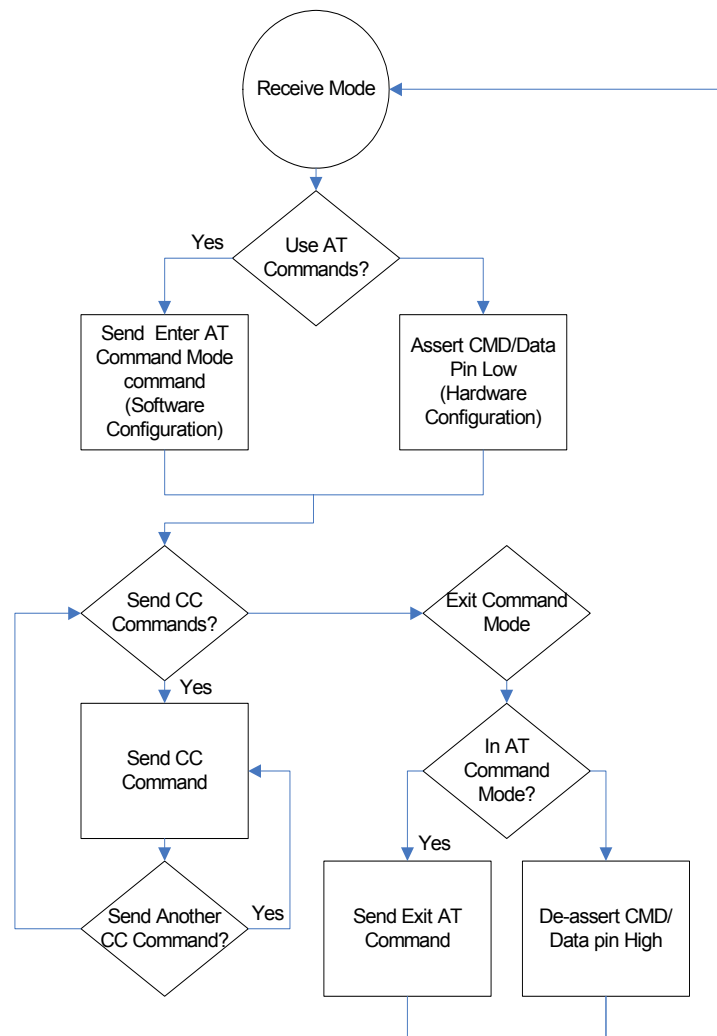

AT COMMANDS

The AT Command mode implemented in the ZB2430 creates a virtual version of the Command/Data pin. The “Enter AT Command Mode” Command asserts this virtual pin Low (to signify Command Mode) and the “Exit AT Command Mode” Command asserts this virtual pin High (to signify Data). Once this pin has been asserted Low, all On-the-Fly CC Commands documented in the manual are supported.

On-the-Fly Control Commands

The ZB2430 transceiver contains static memory that holds many of the parameters that control the transceiver operation. Using the “CC” command set allows many of these parameters to be changed during system operation. Because the memory these commands affect is static, when the transceiver is reset, these parameters will revert back to the settings stored in the EEPROM.

While in Command mode, the incoming RF interface of the transceiver is active and packets sent from other transceivers will still be received; however no outgoing RF packets will be sent. The transceiver uses Interface Timeout/RF Packet Size to determine when a CC Command is complete. Therefore, there should be no delay between each character as it is sent from the OEM Host to the transceiver or the transceiver will not recognize the command.

When an invalid command is sent, the radio discards the data and no response is sent to the OEM Host. Table 8 below shows a quick summary of the basic configuration & diagnostic commands available on the ZB2430. For detailed command information, please refer to the command descriptions immediately following the Quick Reference Table.

Table 8: Command Quick Reference

Command Name	Command (All bytes in Hex)	Return (All bytes in Hex)
Enter AT Command Mode	<0x41> <0x54> <0x2B> <0x2B> <0x2B> <0x0D>	<0xCC> <0x43> <0x4F> <0x4D>
Exit AT Command Mode	<0xCC> <0x41> <0x54> <0x4F> <0x0D>	<0xCC> <0x44> <0x41> <0x54>
Status Request	<0xCC> <0x00> <0x00>	<0xCC> <Firmware> <Status>
Read Channel	<0xCC> <0x02>	<0xCC> <Channel> <Channel Mask [3-0]>
Write Destination NWK Address	<0xCC> <0x10> <0x00> <NWK Hi> <NWK Lo>	<0xCC> <0x00> <NWK Hi> <NWK Lo>
Read Destination NWK Address	<0xCC> <0x11>	<0xCC> <0x00> <NWK Hi> <NWK Lo>
Auto Destination	<0xCC> <0x15> <Data>	<0xCC> <Data>
Read API Control	<0xCC> <0x16>	<0xCC> <API Control>
Write API Control	<0xCC> <0x17> <API Control>	<0xCC> <API Control>
Read Digital Input	<0xCC> <0x20>	<0xCC> <Data>
Read ADC	<0xCC> <0x21> <Data>	<0xCC> <ADC Hi> <ADC Lo>
Write Digital Outputs	<0xCC> <0x23> <Data>	<0xCC> <Data>
Set Power Control	<0xCC> <0x25> <Power>	<0xCC> <Power>
Read NWK Address	<0xCC> <0x8A> <0x00>	<0xCC> <0x8A> <NWK Hi> <NWK Lo>
Read Parent's NWK Address	<0xCC> <0x8A> <0x01>	<0xCC> <0x8A> <NWK Hi> <NWK Lo>

Table 8: Command Quick Reference

Command Name	Command (All bytes in Hex)	Return (All bytes in Hex)
Discover NWK Address	<0xCC> <0x8D> <MAC [2-0]> <Data>	<0xCC> <NWK Hi> <NWK Lo> <Data [n-0]>
Discover IEEE Address	<0xCC> <0x8E> <NWK Hi> <NWK Lo> <Data>	<0xCC> <MAC [7-0]> <Data [n-0]>
Read Temperature	<0xCC> <0xA4>	<0xCC> <Temperature [1-0]>
EEPROM Byte Read	<0xCC> <0xC0> <Start> <Length>	<0xCC> <Start> <Length> <Data [n-0]>
EEPROM Byte Write	<0xCC> <0xC1> <Start> <Length> <Data>	<Start> <Length> <Last byte written>
Soft Reset	<0xCC> <0xFF>	None
Soft Reset with NV reset	<0xCC> <0xFF> <0xE3>	None
Restore Factory Defaults	<0xCC> <0xFF> <0xDF>	None

COMMAND DESCRIPTIONS

Enter AT Command Mode

Prior to sending this command, the OEM Host must ensure that the transceiver's RF transmit buffer is empty. This can be accomplished by waiting up to one second between the last packet and the AT command. If the buffer is not empty, the radio will interpret the command as data and it will be sent over the RF.

Command: <0x41> <0x54> <0x2B> <0x2B> <0x2B> <0x0D>

Number of Bytes Returned: 4

Response: <0xCC> <0x43> <0x4F> <0x4D>

Exit AT Command Mode

The OEM Host should send this command to exit AT Command mode and resume normal operation.

Command: <0xCC> <0x41> <0x54> <0x4F> <0x0D>

Number of Bytes Returned: 4

Response: <0xCC> <0x44> <0x41> <0x54>

Status Version Request

The OEM Host issues this command to request the firmware and link status of the transceiver.

Command: <0xCC> <0x00> <0x00>

Number of bytes returned: 3

Response: <0xCC> <Firmware> <Type>

Parameter Range:

<Firmware> = Radio Firmware version eg: 0x17 = v1.7
 <Type> = 0x00: End Device
 0x01: Router
 0x02: Coordinator
 0x03: Initialized - not started automatically
 0x04: Initialized - not connected to anything
 0x05: Discovering PAN's to join
 0x06: Joining a PAN
 0x07: Rejoining a PAN (only for End Devices)
 0x08: Joined but not yet authenticated
 0x09: Started a NWK as ZigBee Coordinator
 0x0A: Device has lost info about its parent

Read Channel

The OEM Host issues this command to read the channel of the transceiver.

Command: <0xCC> <0x02>

Number of Bytes Returned: 6

Response: <0xCC> <Channel> <ChMask>

Parameter Range:

<Channel> = RF Channel currently in use
 <ChMask> = 32-bit Channel Mask being used

Write Destination Address

The OEM Host issues this command to the transceiver to change the Destination Address.

Command: <0xCC> <0x10> <0x00> <NWK Hi> <NWK Lo>

Number of bytes returned: 4

Response: <0xCC> <0x00> <NWK Hi> <NWK Lo>

Parameter Range:

<NWK Hi> = MSB of destination radio's NWK address
 <NWK Lo> = LSB of destination radio's NWK address

Read Destination Address

The OEM Host issues this command to the transceiver to read the Destination Address.

Command: <0xCC> <0x11>

Number of bytes returned: 4

Response: <0xCC> <0x00> <NWK Hi> <NWK Lo>

Parameter Range:

<NWK Hi> = MSB of destination radio's NWK address

<NWK Lo> = LSB of destination radio's NWK address

Auto Destination

The Host issues this command to change the Auto Destination setting. When issuing this command, the Auto Destination setting will only be changed if the corresponding enable bit is set. Otherwise, the command performs a read of Auto Destination.

Command: <0xCC> <0x15> <Auto Dest>

Number of Bytes Returned: 2

Response: <0xCC> <Auto Dest>

Parameter Range:

<Auto Dest> = bit 7: Ignored
 bit 6: Ignored
 bit 5: Ignored
 bit 4: Read=0, Write =1
 bit 3: Ignored
 bit 2: Ignored
 bit 1: Ignored
 bit 0: Auto Destination

Read API Control

The OEM Host issues this command to read the API Control byte.

Command: <0xCC> <0x16>

Number of Bytes Returned: 2

Response: <0xCC> <API Control>

Parameter Range:

<API Control> = bits 7-3: 0
 bit-2: Send Data Complete
 bit-1: Transmit API
 bit-0: Receive API

Write API Control

The OEM Host issues this command to write the API Control byte to enable or disable the API features.

Command: <0xCC> <0x17> <API Control>

Number of Bytes Returned: 2

Response: <0xCC> <API Control>

Parameter Range:

<API Control> = bits 7-3: Ignored
 bit-2: Send Data Complete
 bit-1: Transmit API
 bit-0: Receive API

Read Digital Input

The OEM Host issues this command to read the state of GIO input pins. Pins configured as outputs will report their current state.

Command: <0xCC> <0x20>

Number of Bytes Returned: 2

Response: <0xCC> <Digital In>

Parameter Range:

<Digital In> = bit-0: GIO

Read ADC

The OEM Host issues this command to read the onboard 12-bit A/D converters.

This command allows a very detailed amount of customization. The OEM Host can select which pin or sensor to monitor, the resolution of the measurement and the reference voltage to measure the input ADC against.

Greater Resolution will provide a more detailed response, but will introduce additional latency.

The following equations can be used to determine the voltages associated with the ADC value returned:

$$ADIn = \left(\frac{\text{ADC value}}{[\text{RES}]} \right) \times [\text{REFvoltage}]$$

Command: <0xCC> <0x21> <Channel> <Resolution> <Ref>

Number of bytes Returned: 3

Response: <0xCC> <Hi ADC> <Lo ADC>

Parameter Range:

<Channel> = 0x00: Cmd/Data

0x01: InRange

0x02: GIO3

0x03: GIO4

0x04: GIO5

0x05: GIO6

0x06: GIO7

0x07: GIO8

0x0D: Positive Voltage Reference = 1.25V

0x0E: Temperature Sensor

0x0F: Vdd

<Resolution> = 0x00: 8 bit resolution [RES=0x00FF]

0x01: 10 bit resolution [RES=0x03FF]

0x02: 12 bit resolution [RES=0x0FFF]

0x03: 14 bit resolution [RES=0x3FFF]

<Reference> = 0x00: Internal 1.25V [REFvoltage= 1.25V]

0x01: External Reference on GIO8

0x02: Vdd

0x03: Differential between pins GIO7 and GIO8

<Hi ADC> = MSB of requested 12-bit ADC value

<Lo ADC> = LSB of requested 12-bit ADC value

Write Digital Outputs

The OEM Host issues this command to write both digital output lines to particular states.

The OEM Host must write the value of all digital outputs at once. Each bit represents a GIO. The first 8 bits are reserved and not in use.

Command: <0xCC> <0x23> <Digital Out[1-0]>

Number of Bytes Returned: 2

Response: 0xCC <Digital Out [1-0]>

Parameter Range:

<Digital Out> = bit-0: GO0

bit-1: GO1

bit-2: GO2

bit-3: GO3

bit-4: GO4

bit-5: GO5

bit-6: GO6

bit-7: GO7

bit-8-15 : Reserved

Set Max Power

The OEM Host issues this command to adjust the maximum output power.

Command: <0xCC> <0x25> <Max Pwr>

Number of Bytes Returned: 2

Response: 0xCC <Max Pwr>

Parameter Range:

<Max Pwr> =	High Power	Low Power
0x00:	17 dBm	0x00: 3 dBm
0x01:	11 dBm	0x01: -3 dBm
0x02:	5 dBm	0x02: -9 dBm
0x03:	-1 dBm	0x03: -15 dBm

Read 16-bit NWK Address

The OEM Host issues this command to determine the 16-bit NWK address of the device it is connected to.

Command: <0xCC> <0x8A> <0x00>

Number of Bytes Returned: 4

Response: <0xCC> <0x8A> <NWK Hi> <NWK Lo>

Parameter Range:

<NWK Hi> = MSB of radio's NWK address
<NWK Lo> = LSB of radio's NWK address

Note: If the device has not yet been assigned, a NWK address of 0xFFFF will be returned.

Read 16-bit NWK Address of Parent Device

The OEM Host issues this command to determine the 16-bit NWK address of its' Parent Device.

Command: <0xCC> <0x8A> <0x01>

Number of Bytes Returned: 4

Response: <0xCC> <0x8A> <NWK Hi> <NWK Lo>

Parameter Range:

<NWK Hi> = MSB of Parent's NWK address
<NWK Lo> = LSB of Parent's NWK address

Note: If the device has not yet associated, a NWK address of 0xFFFF will be returned.

Discover 16-bit NWK Address of Remote Radio

The OEM Host issues this command to discover the 16-bit NWK address of a remote radio.

Note: This command is valid only for Coordinators and/or Router devices. This command will not issue a response if the requested address is unable to be located in the network. A timeout of several seconds should be assumed when using this command.

Command: <0xCC> <0x8D> <IEEE [7-0]>

Number of Bytes Returned: 3

Response: <0xCC> <NWK Hi> <NWK Lo>

Parameter Range:

<IEEE> = 64-bit IEEE Address of remote radio
<NWK Hi> = MSB of remote radio's NWK address
<NWK Lo> = LSB of remote radio's NWK address

Discover IEEE Address of Remote Radio



The OEM Host issues this command to discover the 64-bit IEEE address of a remote radio.

Note: This command is valid only for Coordinators and/or Router devices. This command will not issue a response if the requested address is unable to be located in the network. A timeout of several seconds should be assumed when using this command.

Command: <0xCC> <0x8E> <0x00> <NWK Hi> <NWK Lo>

Number of Bytes Returned: 9

Response: <0xCC> <IEEE [7-0]>

Parameter Range:

<NWK Hi> = MSB of remote radio's NWK address

<NWK Lo> = LSB of remote radio's NWK address

<IEEE> = 64-bit IEEE Address of remote radio

Discover IEEE Address & Children of Remote Radio

The OEM Host issues this command to discover the 64-bit IEEE address of a remote radio as well as report a list of that device's Children.

Note: This command is valid only for Coordinators and/or Router devices. This command will not issue a response if the requested address is unable to be located in the network. A timeout of several seconds should be assumed when using this command.

Command: <0xCC> <0x8E> <0x00> <NWK Hi> <NWK Lo> <0x01>

Number of Bytes Returned: 10+

Response: <0xCC> <IEEE [7-0]> <Length> <List>

Parameter Range:

<NWK Hi> = MSB of remote radio's NWK address

<NWK Lo> = LSB of remote radio's NWK address

<IEEE> = 64-bit IEEE Address of remote radio

<Length> = Length of data to follow

<List> = List of remote radio's associated devices
[<Index n> <NWK Hi n> <NWK Lo n>]

Read Temperature

The OEM Host issues this command to read the onboard temperature sensor.

Note: The temperature sensor is uncalibrated and has a tolerance of +/- 3C. For calibration instructions, contact Aerocomm's technical support.

Command: <0xCC> <0xA4>

Number of bytes returned: 3

Response: 0xCC <+/-> <Temp.>

Parameter Range:

<+/-> = 0x2B: +

0x2D: -

<Temp.> = Temperature (Celsius) (0x08 - 0x50)

Read Voltage

The OEM Hosts issues this command to read the input voltage to the radio.

Command: <0xCC> <0xC0> <0xA6>

Number of Bytes Returned: 2

Response: <0xCC> <Voltage Integer> <Voltage Decimal>

Parameter Range:

<Voltage Integer> = Integer portion of voltage reading

<Voltage Decimal> = Decimal portion of voltage reading

Example Output: 0xCC 0x03 0x37

<0x03> = Integer portion is 3v

<0x37> = decimal portion is .55v

Voltage level is 3.55V

EEPROM Byte Read

Upon receiving this command, a transceiver will respond with the desired data from the addresses requested by the OEM Host.

*Note: Maximum Length is 0xFC.

Command: <0xCC> <0xC0> <Start> <Length>

Number of Bytes Returned: 4+

Response: <0xCC> <Start> <Length> <Data>

Parameter Range:

<Start> = EEPROM address to begin reading at

<Length> = Length of data to be read

<Data> = Requested data

EEPROM Byte Write

Upon receiving this command, a transceiver will write the data bytes to the specified address but will not respond to the OEM Host until the EEPROM write cycle is complete.

Note: The maximum length of data that can be written in a single write process is 0x50. If writing the entire 256-byte EEPROM, it is convenient to perform 64 byte (0x40) writes.

Command: <0xCC> <0xC1> <Start> <Length> <Data>

Number of Bytes Returned: 3

Response: <Start> <Length> <Last byte>

Parameter Range:

<Start> = EEPROM address to begin writing at

<Length> = Length of data to be written (Max = 0x50)

<Data> = Data to be written

<Last byte> = Value of last byte written

Reset

The OEM Host issues this command to perform a soft reset of the transceiver. Any transceiver settings modified by CC commands will revert to the values stored in the EEPROM.

Command: <0xCC> <0xFF>

Number of Bytes Returned: None

Response: None

Restore Factory Defaults

The OEM Host issues this command to restore the EEPROM Configuration to factory default.

*Note. This command does not perform a NV Reset.

Command: <0xCC> <0xFF> <0xDF>

Number of Bytes Returned: None

Response: None

Soft Reset with NV reset

The OEM Host issues this command to perform a soft reset of the transceiver and to erase the network settings stored in the radio's non-volatile memory. Any transceiver settings modified by CC commands will revert to the values stored in the EEPROM.

Command: <0xCC> <0xFF> <0xE3>

Number of Bytes Returned: None

Response: None

EEPROM PARAMETERS

The OEM Host can program various parameters that are stored in EEPROM and become active after a power-on reset. The table below gives the locations and descriptions of the parameters that can be read/written by the OEM Host. Factory default values are also shown. Do not write to any EEPROM addresses other than those listed below. Do not copy one transceiver's EEPROM to another transceiver as doing so may cause the transceiver to malfunction.

Table 9: EEPROM Parameters

Parameter	EEPROM Address	Length (Bytes)	Range	Default	Description
Product ID	0x00	40			Product identifier string. Includes revision information for software and hardware.
Channel Mask	0x30	4		0x07FFF800	When Channel Select is enabled in EEPROM, tells the radio the available channels to use in Channel Select mode.
End Device Poll Rate	0x34	2	0x0000 - 0xFFFF	0x03E8	Specifies how often the End Device will wakeup from Sleep Mode, and request data from its parent. 1 ms per increment. Note: Valid only for End Devices
Parent Hold Message	0x39	1	0x00 - 0xFF	0x42	Specifies the amount of time that a Parent Device will hold a message for a sleeping End Device before discarding. 1000 ms per increment. Note: Valid only for Coordinator and Routers
End Device Wake Time	0x3A	2	0x0000 - 0xFFFF	0x0064	Specifies the amount of time that an End Device will remain awake. 1 ms per increment. Note: Valid only for End Devices
End Device Wake Poll Rate	0x3C	2	0x0000 - 0xFFFF	0x0032	Specifies how often the End Device should request messages from its Parent Device while awake. 1 ms per increment. Note: Valid only for End Devices
Stop Bit Delay	0x3F	1	0x00 - 0xFF	0x00	For systems employing the RS-485 interface or Parity, the serial stop bit might come too early. Stop bit delay controls the width of the last bit before the stop bit occurs. Should be set to 2 times the byte time when used. 0x00 = Disable stop bit delay Note: Stop bit delay only needs to be used when using external RS485 hardware or RS485 DE/RE.
Channel Number	0x40	1	0x0B - 0x1A	0x0B	RF Channel Number. Used when Channel Select mode is disabled.

Table 9: EEPROM Parameters

Parameter	EEPROM Address	Length (Bytes)	Range	Default	Description
Baud Rate	0x42	1	0x00 - 0x08, 0xE3	0x06	0x00: 1200 0x01: 2400 0x02: 4800 0x03: 9600 0x04: 19200 0x05: 31250 0x06: 38400 0x07: 57600 0x08: 115200 0xE3: Enable Custom Baud rate Note: If any value other than 0x00-0x08 or 0xE3 is used, the radio will default to 9600 baud.
Baud_M	0x43	1	0x00 - 0xFF	0xFF	Used to calculate baud rate when Custom Baud Rate is enabled.
Baud_E	0x44	1	0x00-0xFF	0xFF	Used to calculate baud rate when Custom Baud Rate is enabled.
Control 0	0x45	1	0x01 - 0xFF	0x38	Settings are: bit-7: Reserved bit-6: Reserved bit-5: Modify Wake 0 = Disabled 1 = Enabled bit-4: Reload Sleep 0 = Disabled 1 = Enabled bit-3: NV Restore 0 = Disabled 1 = Enabled bit-2: End-to-End Acknowledgement 0 = Disabled 1 = Enabled bit-1: Reserved bit-0: Reserved
MAC Retries	0x4B	1	0x00 - 0x07	0x03	Specifies the number of retries to use at the MAC level. A setting of 0x03 actually sends the packet up to 4 times. MAC retries can be set to 0x00, but since they occur faster than the transmit retries, the default setting is typically recommended.
Network Retries	0x4C	1	0x01 - 0x07	0x02	Specifies the maximum number of network retries. When MAC retries is not set to 0x00, the actual amount of transmit attempts is equal to MAC retries x Network Retries. Network Retries occur at a slower rate than MAC retries. Network retries are retries that occur between two connected nodes.
Broadcast Attempts	0x4D	1	0x00 - 0x05	0x04	Specified the maximum number of times to broadcast a packet. Attempts occur at 500ms intervals. There is a limit of 9 broadcast messages every 10 seconds.
End-to-End Retries	0x4E	1	0x00 - 0xFF	0x04	Specified the maximum number of times to retry an end to end packet. End to End Retries are only suitable for multihop packets.. Attempts occur at 6s intervals.

Table 9: EEPROM Parameters

Parameter	EEPROM Address	Length (Bytes)	Range	Default	Description
Stale Limit	0x4F	1	0x01-0xFF	0x32	Specifies amount of time to keep a radio in the Radio Table without having received a packet from that particular radio. Prevents retries from being interpreted as new packets. Adjustable in 100 ms increments.
Control 1	0x56	1	0x01 - 0xFF	0x43	Settings are: bit-7: RS495 DE/RE 0 = Disabled 1 = Enabled bit-6: Reserved bit-5: Reserved bit-4: Auto Destination 0 = Use Destination Address 1 = Use Auto Destination bit-3: Auto Channel 0 = Disabled 1 = Enabled bit-2: Reserved bit-1: Reserved bit-0: Reserved
Interface Timeout	0x58	1	0x02 - 0xFF	0x04	Specifies a byte gap timeout, used in conjunction with RF Packet Size to determine when a packet coming over the interface is complete. Note: 1 ms per increment.
RF Packet Size	0x5A	2	0x0001 -0x0054	0x0054	Specifies the RF packet size. Note: RF packet size needs to be set to a minimum of six bytes in order to use the Enter AT command.
$\overline{\text{CTS}}$ On	0x5C	2	0x0001 - 0x01C0 Coordinator /Router: 0x0001 - 0x0416 End Device: 0x0001 - 0x0096	Coordinator /Router: 0x0190 End Device: 0x50	$\overline{\text{CTS}}$ will be deasserted (High) when the Transmit buffer contains at least this many characters
$\overline{\text{CTS}}$ Off	0x5E	2	0x0001 - 0x01C0 Coordinator /Router: 0x0001 - 0x0416 End Device: 0x0001 - 0x0096	Coordinator /Router: 0x0180 End Device: 0x50	Once $\overline{\text{CTS}}$ has been deasserted, $\overline{\text{CTS}}$ will be reasserted (Low) when the transmit buffer contains this many or less characters.
Power Control	0x63	1	0x00 - 0x03	0x00	Determines output power of transceiver. ZB2430-Q 0x00: 17 dBm 0x01: 11 dBm 0x02: 5 dBm 0x03: -1 dBm ZB2430-D 0x00: 3 dBm 0x01: -3 dBm 0x02: -9 dBm 0x03: -15 dBm
Destination ID	0x76	2	0x0000 - 0xFFFF	R/E: 0x0000 C: 0x0001	Specifies destination for RF packets.
PAN ID	0x78	2	0x0000 - 0x3FFF	0x0001	Similar to network name. Radios must have the same PAN ID to associate with each other.

Table 9: EEPROM Parameters

Parameter	EEPROM Address	Length (Bytes)	Range	Default	Description
MAC ID	0x80	8	0x00 - 0xFF		Factory programmed 8 byte unique IEEE MAC address. Note: This address is write protected and cannot be modified.
Part Number	0x90	16	0x00 - 0xFF		Provides part number information. EEPROM byte 0x95 can be read to determine device type (C, R, or E).
API Control	0xC1	1	0x00 - 0xFF	0xF8	Settings are: bit-7: Reserved bit-6: Reserved bit-5: Reserved bit-4: Reserved bit-3: Reserved bit-2: API Send Data Complete 0 = Disabled 1 = Enable bit-1: Transmit API 0 = Disabled 1 = Enabled bit-0: Receive API 0 = Disabled 1 = Enabled
RSSI Threshold	0xC8	1	0x00 - 0xFF		The minimum RSSI required. Packets received with a weaker RSSI than this threshold will be discarded.
D.O.B.	0xE0	4			Provides factory calibration and test date.

API OPERATION

API Operation is a powerful alternative to the default Transparent operation of the ZB2430 and provides dynamic packet routing and packet accounting abilities to the OEM Host without requiring extensive programming by the OEM Host.. API operation utilizes specific packet formats; specifying various vital parameters used to control radio settings and packet routing on a packet-by-packet basis. The API features can be used in any combination that suits the OEM's specific needs and can be different between radios operating on the same network.

API Transmit Packet

API Transmit Packet is a powerful command that allows the OEM Host to send data to a single or multiple (broadcast) transceivers on a packet-by-packet basis. This can be useful for many applications; including polling and/or mesh networks.

API Transmit Packet is enabled when bit-1 of the API Control byte is enabled. The OEM Host should use the format shown in Figure 12 below to transmit a packet over the RF.

Figure 12: Transmit API packet format

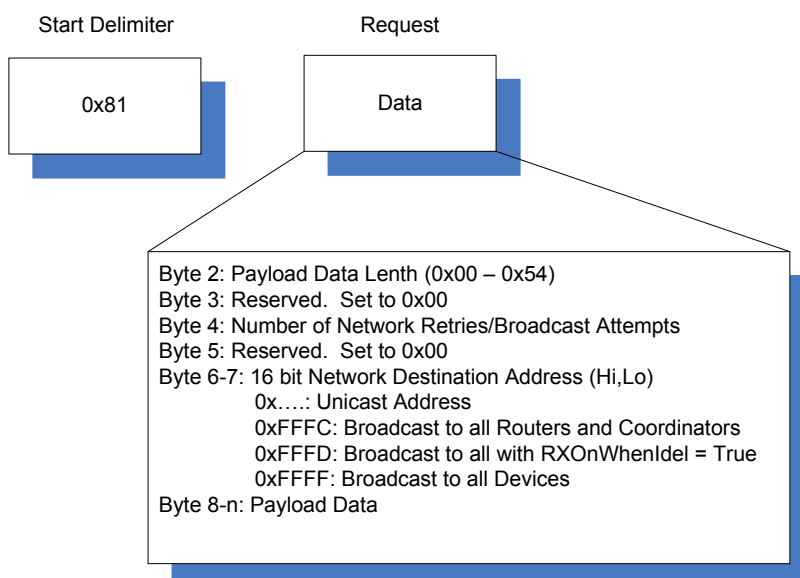

API Send Data Complete

API Send Data complete can be used as a software acknowledgement indicator. When a radio sends an addressed packet, it will look for a received acknowledgement (transparent to the OEM Host). If an acknowledgement is not received, the packet will be retransmitted until one is received or all retries have been exhausted.

For applications where data loss is not an option, the OEM Host may wish to monitor the acknowledgement process using the API Send Data Complete. If an acknowledgement is not received (Failure), the OEM Host can send the packet to the transceiver once again.

API Send Data Complete is enabled when bit-2 of the API Control byte is enabled. The transceiver sends the OEM Host the data shown in Figure 13 upon receiving an RF acknowledge or exhausting all attempts.

*Note: Send Data Complete may report a failure though the packet arrived due to timing issues. It will never report successful though unless the packet absolutely arrived.

Figure 13: Send Data Complete packet format

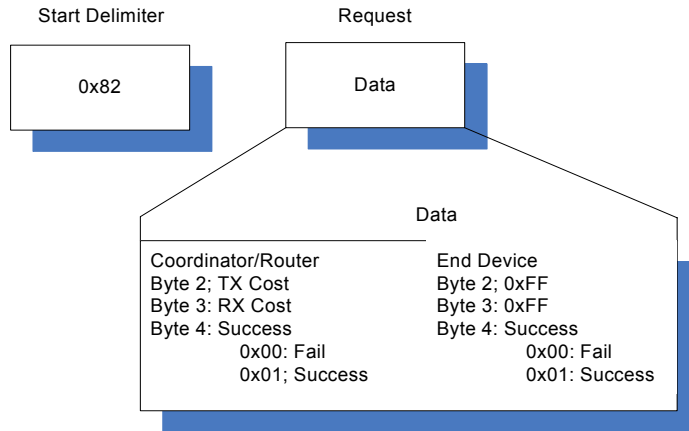

API Receive Packet

By default, the source MAC is not included in the received data string sent to the OEM Host. For applications where multiple radios are sending data, it may be necessary to determine the origin of a specific data packet. When API Receive Packet is enabled, all packets received by the transceiver will include the MAC address of the source radio as well as an RSSI indicator which can be used to determine the link quality between the two.

API Receive Packet is enabled when bit-0 of the API Control byte is enabled. Upon receiving a RF packet, the radio sends its OEM Host the data as shown in Figure 14 below.

Figure 14: Receive API packet format

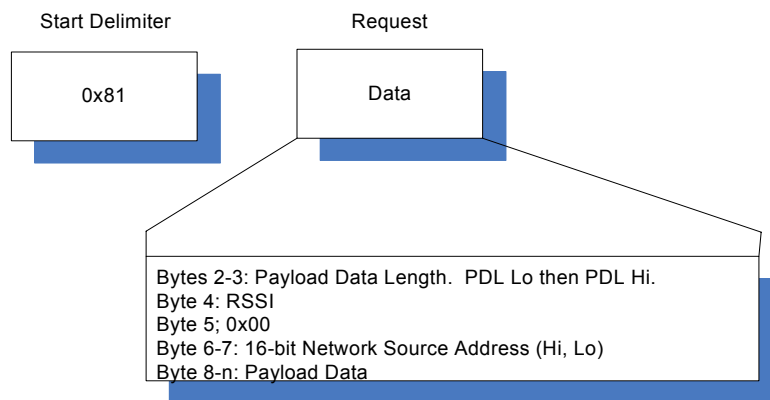

ZB2430 ADDRESSING

Every ZB2430 transceiver module has a unique static 64-bit MAC address that is programmed at the factory. Upon joining the network, the device is assigned a 16-bit NWK Address. The NWK address only changes on initial power-up and when a NV Reset command is issued to the radio.

In Figure 15 four nodes with the three LSBs of each of their MAC addresses are shown.

Figure 15: ZigBee Addressing by MAC - Node 0 to Node 3

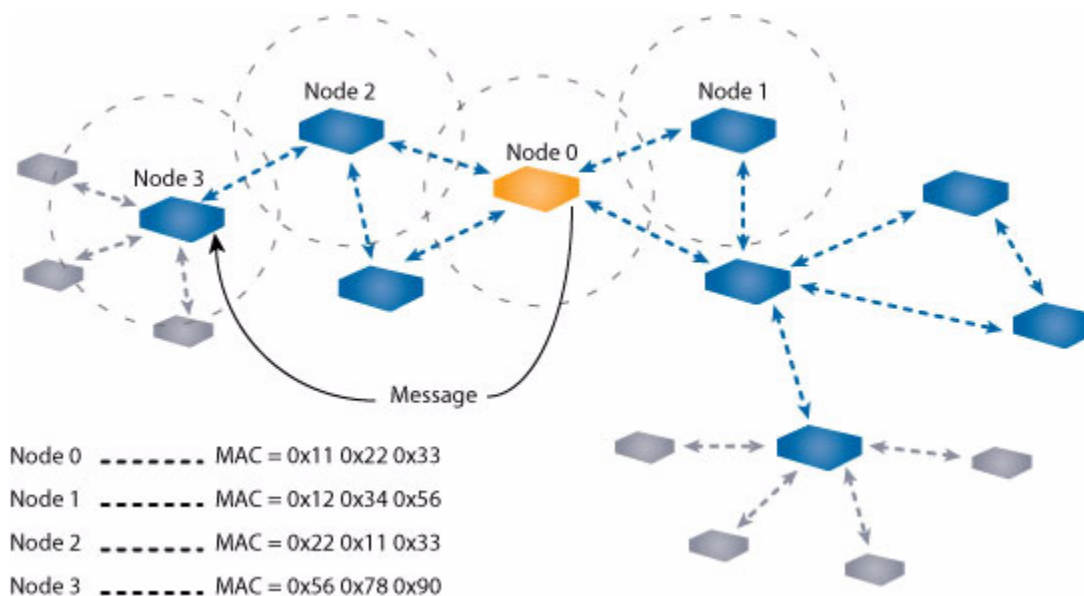

In previous sections (see “Mesh Routing (AODV)” on page 16), the Ad-Hoc On-Demand Vector routing protocol, Route Requests and Replies were discussed. Fortunately, the routing, RREQ’s and RREP’s are not left up to the OEM Host and are all taken care of by the ZigBee protocol embedded in the ZB2430. A message can therefore be sent to a device anywhere on the network once its 16-bit NWK address is known.

Using the same example as before, assume that Node 0 needs to send a message to Node 3 which is out of Node 0’s range. This can be done using the procedure below (note that the underlined values will vary from radio to radio):

1. Enter AT Command Mode: 0x41 0x54 0x2B 0x2B 0x2B 0x0D
2. Wait for command response:..... 0xCC 0x43 0x4F 0x0D
3. Discover NWK Address:..... 0xCC 0x8D 0x56 0x78 0x90
4. Wait for command response:..... 0xCC 0x00 0x01
5. Write 16-bit Destination NWK address:..... 0xCC 0x10 0x00 0x00 0x01
6. Wait for command response:..... 0xCC 0x00 0x00 0x01
7. Exit AT Command Mode:..... 0xCC 0x41 0x54 0x4F 0x0D

8. Wait for command response:..... 0xCC 0x44 0x41 0x54
9. Send data to device

Figure 16: ZigBee Addressing by MAC - Node 0 to Node 2

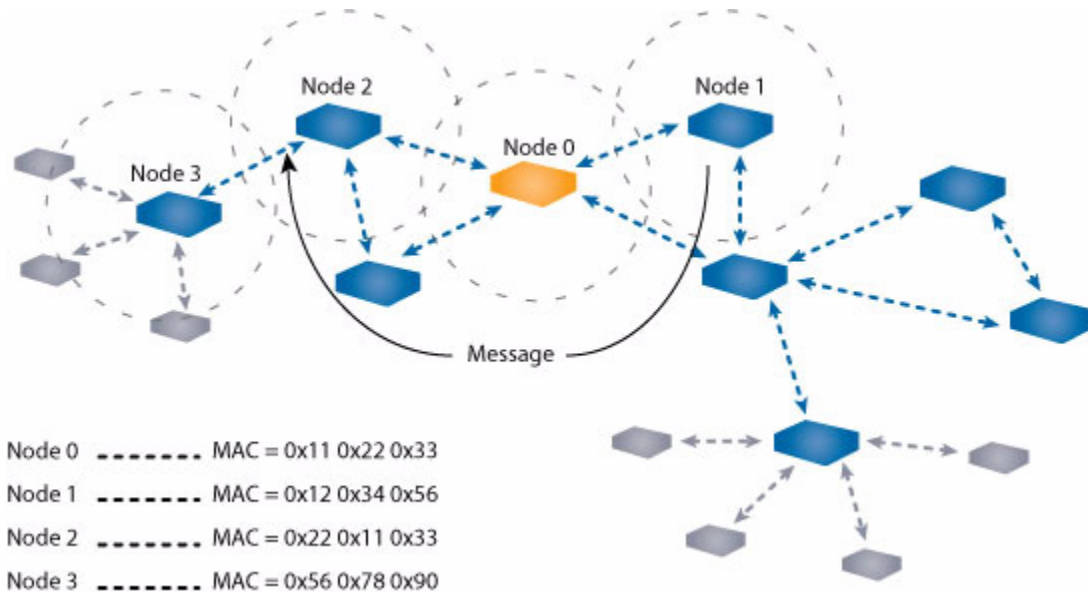

Next, assume that Node 1 needs to send a message to Node 2, which is also out of its range. The procedure is the essentially the same as above (see Figure 16: "ZigBee Addressing by MAC - Node 0 to Node 2"). Note that the underlined values will vary from radio to radio.

1. Enter AT Command Mode: 0x41 0x54 0x2B 0x2B 0x2B 0x0D
2. Wait for command response:..... 0xCC 0x43 0x4F 0x0D
3. Discover NWK Address:..... 0xCC 0x8D 0x22 0x11 0x33
4. Wait for command response:..... 0xCC 0x14 0x3E
5. Write 16-bit Destination NWK address:..... 0xCC 0x10 0x00 0x14 0x3E
6. Wait for command response:..... 0xCC 0x00 0x14 0x3E
7. Exit AT Command Mode: 0xCC 0x41 0x54 0x4F 0x0D
8. Wait for command response:..... 0xCC 0x44 0x41 0x54
9. Send data to device

ADVANCED NETWORK COMMANDS

Some applications may require a more extensive knowledge of the Network and its current configuration. For this reason, the ZB2430 includes several advanced commands which can be issued anytime the radio is in Command mode. Each of these commands include a 16-bit Return Mask which allows the OEM Host to select the information returned in the command response.

Note: All unused bits in the Return Mask should be set to “0”.

Read Neighbor Table

The Neighbor Table is stored in NV RAM in stores information about neighboring devices which are operating with the same Channel Mask, but not necessarily the same channel. The command format is shown in Figure 17.

Command Definitions

- Start Index: Starting index within the Neighbor Table to begin reporting.
- Count: Number of entries to include in Neighbor Table. Maximum number of indexes = 8 (Coordinator and Routers) and 4 (End Devices).
- Index Number: Index location of radio in Route Table.
- NWK Address: 16-bit NWK address of the neighboring device.
- PAN ID: The 16-bit PAN ID of the network to which the device belongs.
- TX Cost: Counter of transmission (success/failures)
- RX Cost: Average of received RSSI values for the specified device

Figure 17: Read Neighbor Table Command

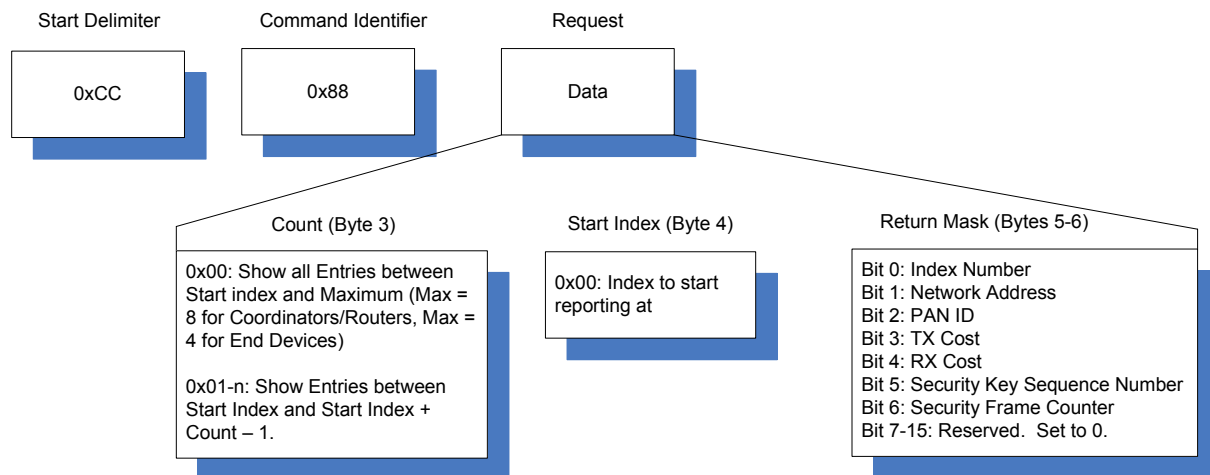

After issuing the Read Neighbor Table command, the radio will respond with the requested information as shown in Figure 18 below. The actual command response format may vary depending on the Return Mask setting used in the command.

*Note: Command will only fail if more than the maximum number of neighbors is requested.

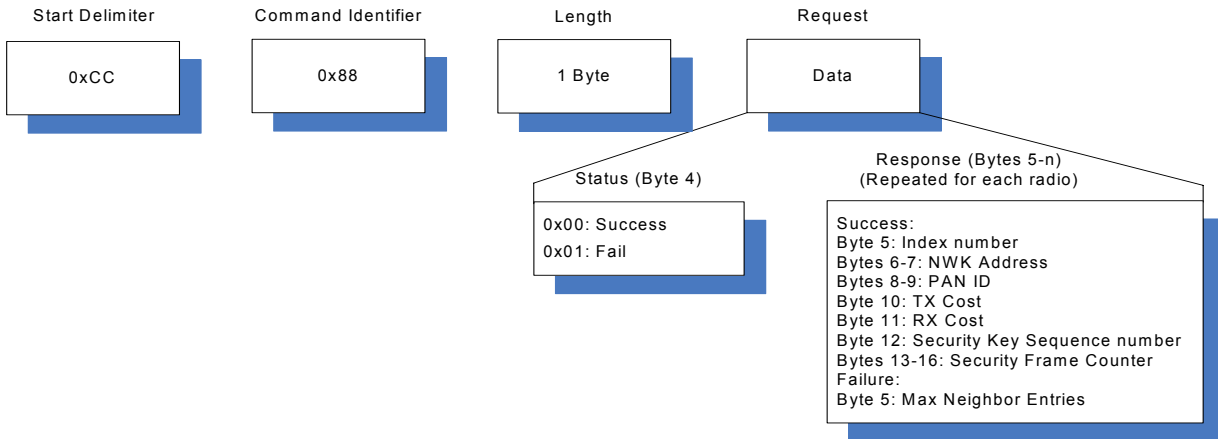
Figure 18: Read Neighbor Table Response

Read Route Table

ZigBee Coordinators and Routers maintain a routing table in memory which is used to establish a route to a particular destination device.

Note: This command is not valid for End Devices.

Command Definitions

- Count: Number of entries to include in Route Table. Maximum number of indexes = 20
- Start Index: Starting index within the Route Table to begin reporting.
- Index Number: Index location of radio in Route Table.
- Destination Address: The 16-bit NWK address of the route.
- Next Hop Address: The 16-bit NWK address of the next radio on the way to the destination.
- Expiry Time: A countdown timer indicating the number of seconds until route expires. Expiry Time is set to 0x1E (30s) when a new route is created.
- Status: The status of the route.
- Command will fail if the maximum requested entries is greater than 20.

Figure 19: Read Route Table Command

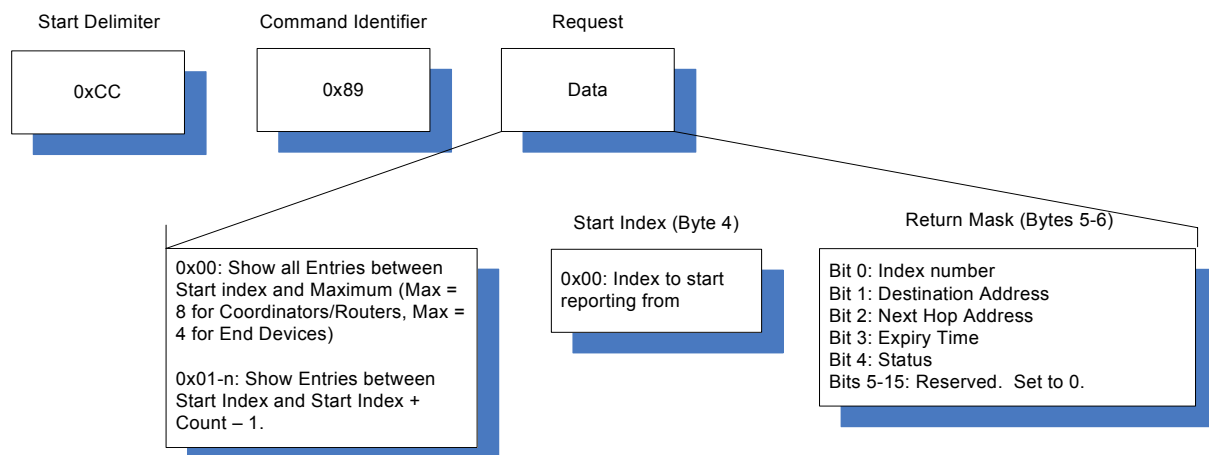
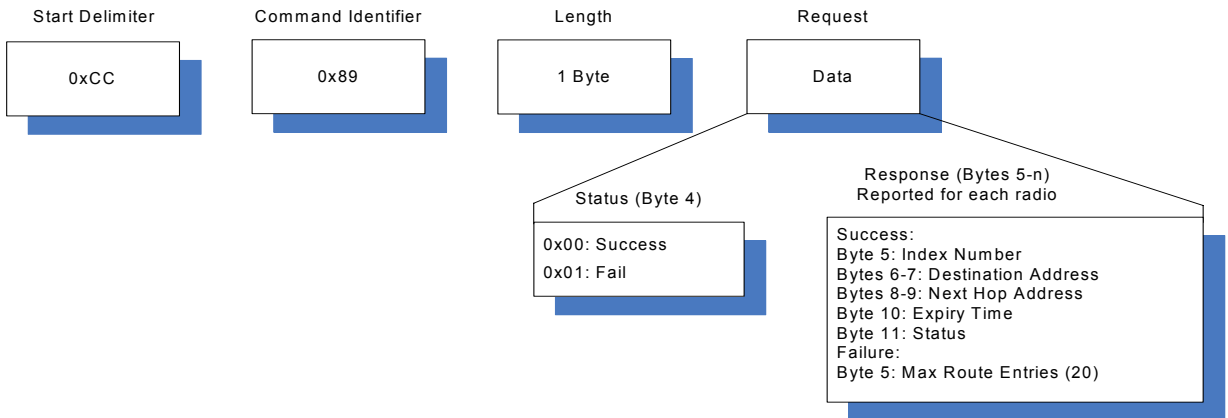

Figure 20: Read Route Table Response

Perform Scan

ZigBee Coordinators and Routers can manually scan selected channels for RF activity and other ZigBee devices/PAN ID's, etc.

Note: This command not valid for End Devices.

Command Definitions

- Scan Channel: A 32-bit channel mask specifying the channel(s) to include in the scan.
- Scan Type: Specifies the type of scan to perform. Energy scan, the device will tune to each channel & perform an energy measurement. Active scan, the device tunes to each channel, sends a beacon request and listen for beacons from other ZigBee devices.
- Scan Duration: Duration of the Active & Energy scans on each channel selected. Time is measured as: $(15.36ms) \times 2^{(Scan\ Duration + 1)}$
- Max Results: The maximum number of results to report for Active scans. Ignored with Energy scan command.
- Status: Indicates the status of the current scan.
- Channel Number: 8-bit channel current measurement was taken from.
- Energy: The strength of the RF channel during the Energy scan.
- NWK Address: 16-bit NWK address of the neighboring device.
- PAN ID: The 16-bit PAN ID of the network to which the device belongs.
- Link Quality: The strength of the link between the current device and the device found during the Active scan.

Figure 21: Perform Scan Command

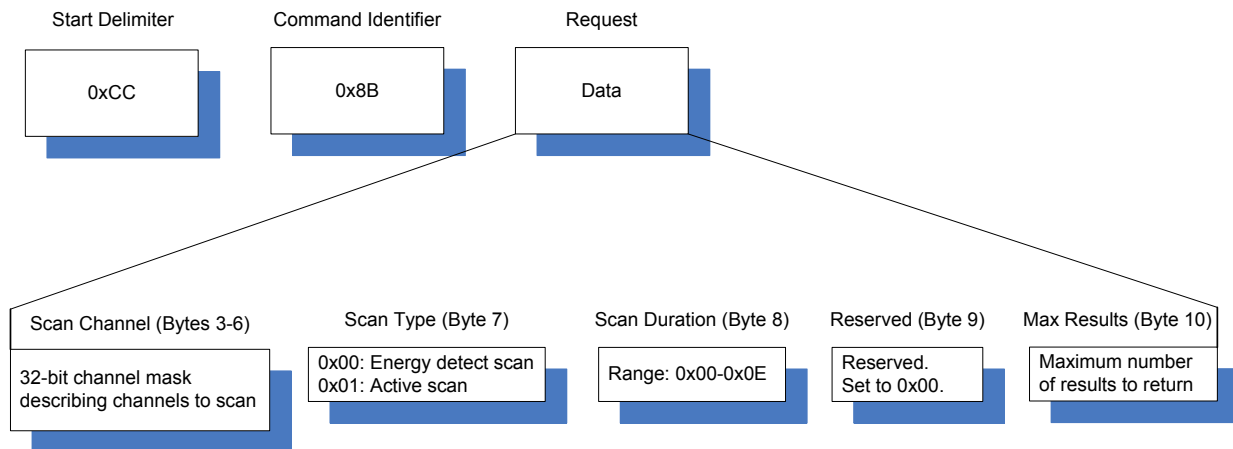
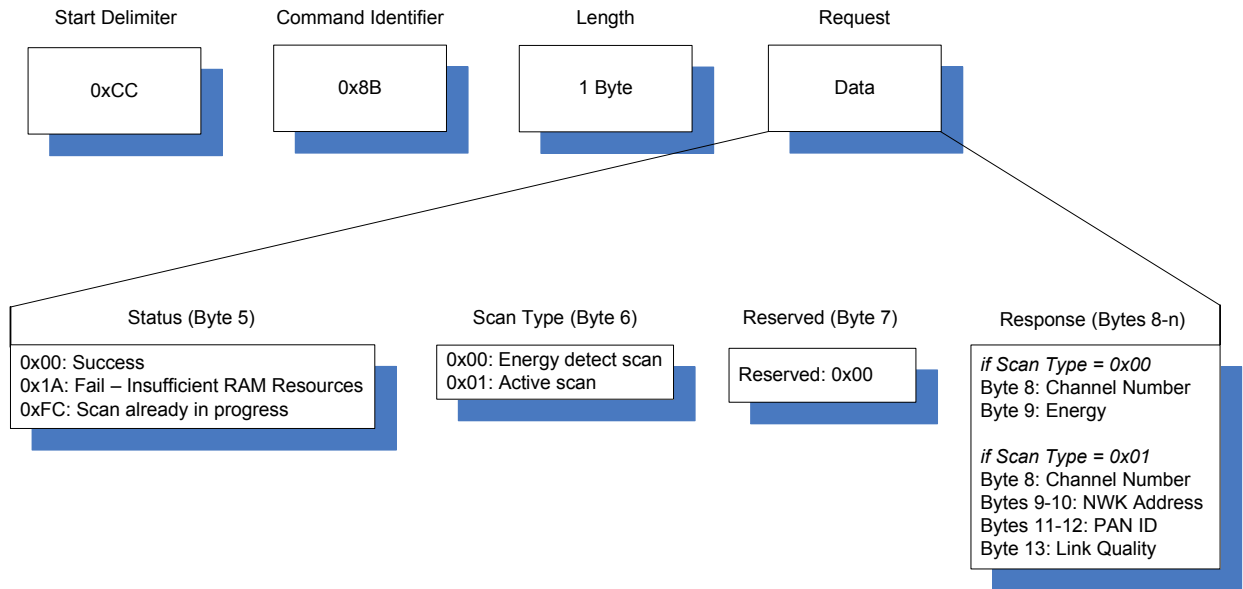

Figure 22: Perform Scan Response



Read Radio Table

The Radio Table, stored in NV RAM, contains information about any parent or children it is associated with. The Radio Table stores relationship and link-state information which updates everytime the radio receives a packet from that device. To read a device's Radio Table, use the command format shown in Figure 23 below.

Note: This command not valid for End Devices.

Command Definitions

- Index Number: Index location of radio in Radio Table (range = 0-20).
- NWK Address: 16-bit NWK address of the device.
- Node Relation: The type/relation of the device.
- Device Status: Status of the link between the two devices.
- TX Cost: Counter of transmission (success/failures). Failures are incremented on fail and decremented on success. Range is 0x00 - 0x07.
- RX Cost: Average of received RSSI values for the specified device

Figure 23: Read Radio Table Command

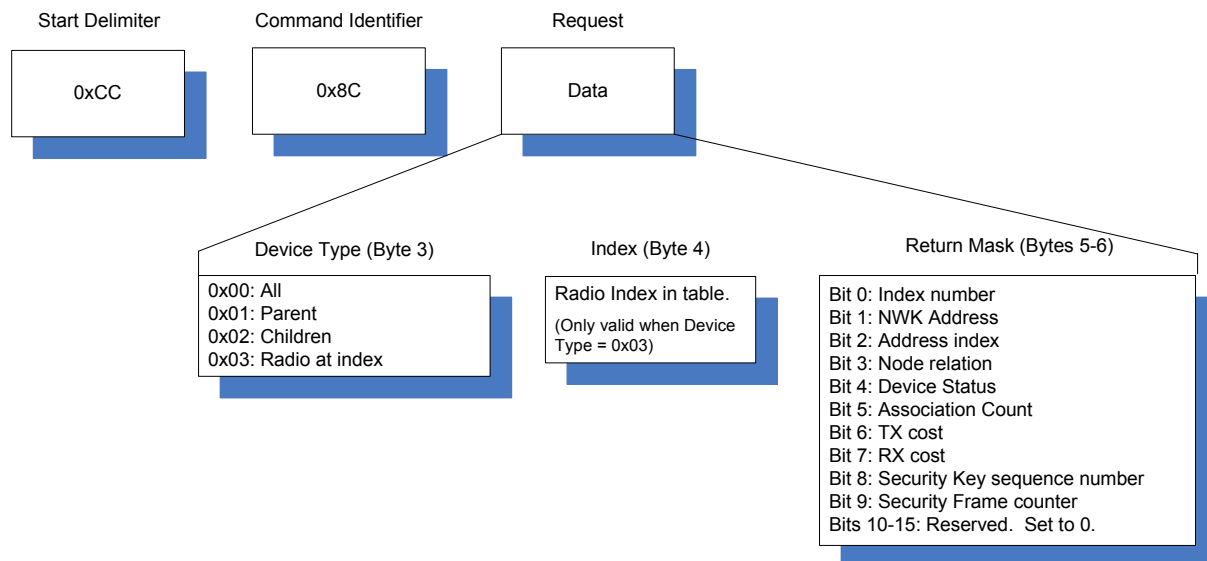

After issuing the Read Radio Table command, the radio will respond with the requested information as shown in Figure 24 below. The actual command response format may vary depending on the Return Mask setting used in the command.

Figure 24: Read Radio Table Response

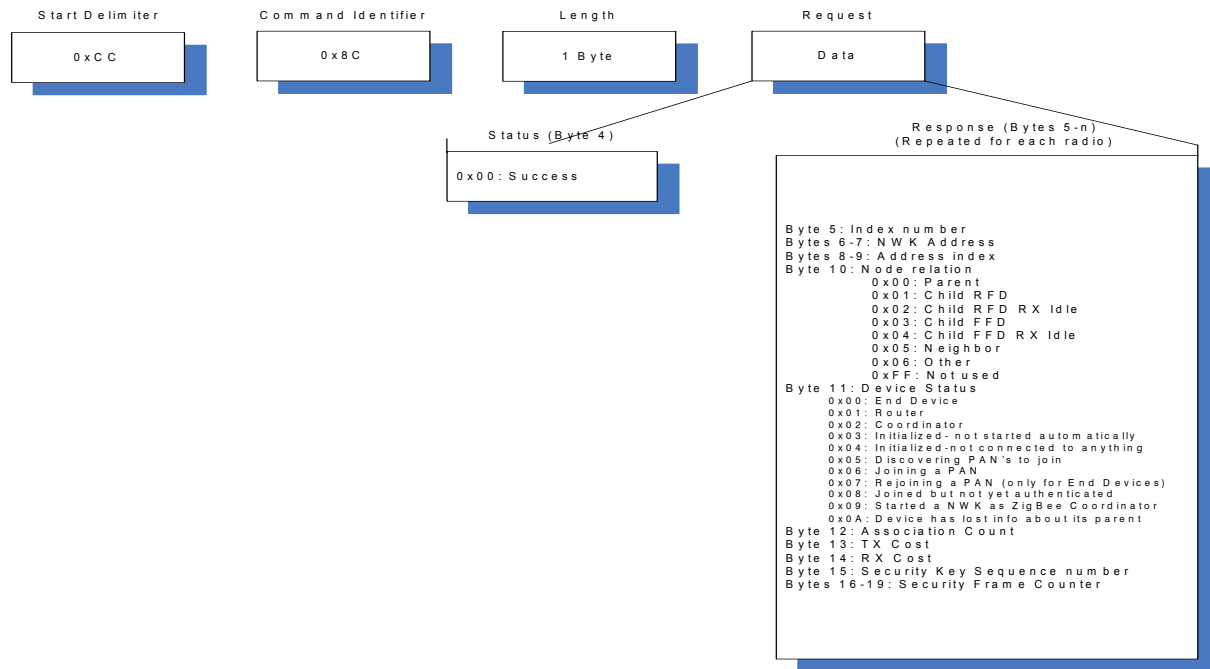

DIMENSIONS

ZB2430 MECHANICAL

Figure 25: ZB2430 Mechanical Drawing

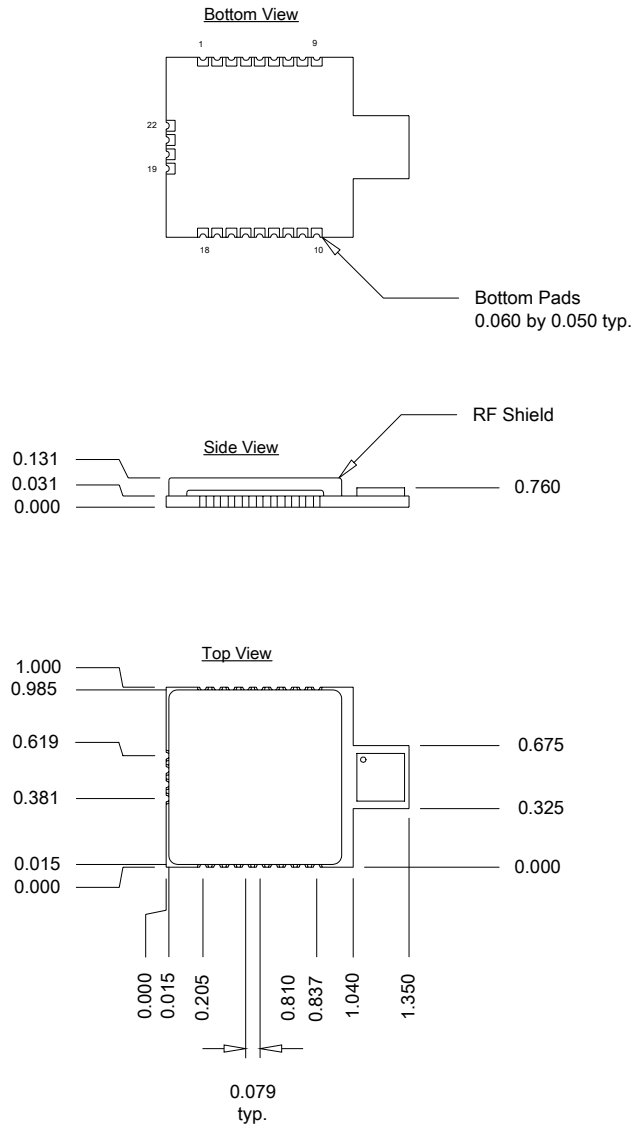

Notes:
 All dimensions are +/- .005 inches
 PC Board Material is 0.031 thick FR4
 Board edge connections are 1/2 of 0.031 plated holes

ORDERING INFORMATION

PRODUCT PART NUMBERS

"D" Version	ZB243 _ - D - _ - S - _	(a) 0 = Standard 1 = Location Engine
	part (a) (b) (c) (d) (e)	
"Q" Version	ZB243 _ - D - _ - S - _	(b) D = Low Power (2 mW) Q = High Power (100 mW)
	part (a) (b) (c) (d) (e)	(c) C = Coordinator R = Router E = End Device
		(d) S = Surface mount P = Pluggable
		(e) A = Chip antenna U = U.FL antenna

COMPLIANCE INFORMATION

AGENCY IDENTIFICATION NUMBERS

Agency compliance is a very important requirement for any product development. Aerocomm is in the process of obtaining modular approval for its ZB2430 product family so that the OEM only needs to meet a few requirements to use that approval. The corresponding agency identification numbers and approved antennas are listed below.

Table 10: Agency Identification Numbers

Part Number	US/FCC	CANADA/IC	ETSI
ZB2430-D	KQL-ZB2430D	2268C-ZB2430D	Approved
ZB2430-100	KQL-ZB2430-100	2268C-ZB2430	Pending

APPROVED ANTENNA LIST

The following antennas are approved for operation with the ZB2430 as identified. The OEM is free to choose another vendor's antenna of like type and equal or lesser gain as an antenna appearing in the table and still maintain compliance.

Table 11: ZB2430 Approved Antenna List

Aerocomm Part Number	Manufacturer Part Number	Manufacturer	Type	Gain (dBi)	ZB2430-D	ZB2430-100
-	FR05-S1-N-o-001	Fractus	Integral Chip	2	-	X
0600-00039	S151FC-L-(132)PX-2450S	Nearson	Omni	5	X	X
	WIC2450-A	Laird/Centurion	Chip	2	X	-

FCC / IC REQUIREMENTS FOR MODULAR APPROVAL

In general, there are two agency classifications of wireless applications; portable and mobile.

Portable - Portable is a classification of equipment where the user, in general, will be within 20 cm of the transmitting antenna. Portable equipment is further broken down into two classes; within 2.5 cm of human contact and beyond 2.5 cm (**Note:** Ankles, feet, wrists, and hands are permitted to be within 2.5 cm of the antenna even if the equipment is designated as being greater than 2.5 cm). The ZB2430 is not agency approved for portable applications. The OEM is required to have additional testing performed to receive this classification. Contact AeroComm for more details.

Mobile - Mobile defines equipment where the user will be 20 cm or greater from the transmitting equipment. The antenna must be mounted in such a way that it cannot be moved closer to the user with respect to the equipment, although the equipment may be moved. (**Note:** Ankles, feet, wrists, and hands are permitted to be within 20 cm of mobile equipment).

OEM EQUIPMENT LABELING REQUIREMENTS

WARNING: The OEM must ensure that FCC labeling requirements are met. This includes a clearly visible label on the outside of the OEM enclosure specifying the appropriate AeroComm FCC identifier for this product as well as the FCC notice below. The FCC identifiers are listed above.

Contains FCC ID: KQL-ZB2430-100 / KQL-ZB2430D

The enclosed device complies with Part 15 of the FCC Rules. Operation is subject to the following two conditions: (1) This device may not cause harmful interference, and (2) This device must accept any interference received, including interference that may cause undesired operation.

Label and text information should be in a size of type large enough to be readily legible, consistent with the dimensions of the equipment and the label. However, the type size for the text is not required to be larger than eight point.

ANTENNA REQUIREMENTS

WARNING: This device has been tested with a U.FL connector with the above listed antennas. When integrated into the OEM's product, these fixed antennas require professional installation preventing end-users from replacing them with non-approved antennas. Any antenna not listed in the above table must be tested to comply with FCC Section 15.203 for unique antenna connectors and Section 15.247 for emissions. Contact AeroComm for assistance.

Caution: Any changes or modifications not expressly approved by AeroComm could void the user's authority to operate the equipment.

WARNINGS REQUIRED IN OEM MANUALS

WARNING: This equipment has been approved for mobile applications where the equipment should be used at distances greater than 20 cm from the human body (with the exception of hands, feet, wrists, and ankles). Operation at distances of less than 20 cm is strictly prohibited and requires additional SAR testing.

CHANNEL WARNING

The OEM must prevent the end-user from selecting a channel not approved for use by the FCC.



