

阅读申明

- 1.本站收集的数据手册和产品资料都来自互联网，版权归原作者所有。如读者和版权方有任何异议请及时告之，我们将妥善解决。
- 2.本站提供的中文数据手册是英文数据手册的中文翻译，其目的是协助用户阅读，该译文无法自动跟随原稿更新，同时也可能存在翻译上的不当。建议读者以英文原稿为参考以便获得更精准的信息。
- 3.本站提供的产品资料，来自厂商的技术支持或者使用者的心得体会等，其内容可能存在描述上的差异，建议读者做出适当判断。
- 4.如需与我们联系，请发邮件到marketing@iczoom.com，主题请标有“数据手册”字样。

Read Statement

1. The datasheets and other product information on the site are all from network reference or other public materials, and the copyright belongs to the original author and original published source. If readers and copyright owners have any objections, please contact us and we will deal with it in a timely manner.
2. The Chinese datasheets provided on the website is a Chinese translation of the English datasheets. Its purpose is for reader's learning exchange only and do not involve commercial purposes. The translation cannot be automatically updated with the original manuscript, and there may also be improper translations. Readers are advised to use the English manuscript as a reference for more accurate information.
3. All product information provided on the website refer to solutions from manufacturers' technical support or users the contents may have differences in description, and readers are advised to take the original article as the standard.
4. If you have any questions, please contact us at marketing@iczoom.com and mark the subject with "Datasheets" .

FM Transmitter & Receiver Hybrid Modules

Features

- FM Radio Transmitters & Receivers
- Available 433MHz
- Transmit Range up to 250m
- Miniature Packages
- Data Rate up to 9.6Kbps
- No Adjustable Components
- Very Stable Operating Frequency
- Operates from -20 to +85°C
- EMC Compliant for use in Europe
- FCC Compliant for use in USA

Transmitter

- 3V Supply Voltage
- SIL, DIL or SMT Packages available

Receiver

- PLL XTAL Design
- CMOS/TTL Output
- RSSI Output
- Standby Mode (max 100nA)
- 5V Supply Voltage

Applications

- Wireless Security Systems
- Car Alarms
- Remote Gate Controls
- Remote Sensing
- Data Capture
- Sensor Reporting

Description

These miniature RF modules provide a cost effective high performance FM Radio data link, at, 433.92MHz. The modules uses no adjustable components ensuring very reliable operation.

This transmitter and receiver pair enables the simple implementation of a data link at distances up to 75 metres in-building and 250 metres open ground.

The modules have been approved for operation with Europe and USA within FCC part15.

These modules will suit one-to-one and multi-node wireless links in applications including car and building security, EPOS and inventory tracking, remote industrial process monitoring and computer networking. Because of their small size and low power requirements both modules are ideal for use in portable, battery-powered applications such as hand-held terminals.



RTFQ1P

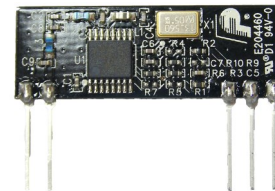
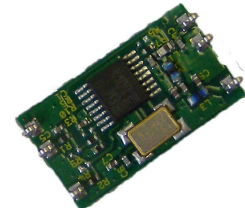

RTFQ2P

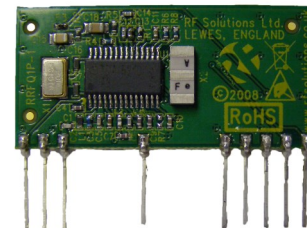

RRFQ1P

FM Transmitter & Receiver Modules



Transmitters

There are three versions of transmitter:

- RTFQ1; A dual in line package operating at 3.3V. This provides the most rugged mechanical fixing to the host PCB. Power down mode is also available.
- RTFQ1 SM: A dual in line surface mount package operating at 3.3V. This provides the quickest and most efficient mechanical fixing to the host PCB.
- RTFQ2; A Single in line package operating at 3.3V

Transmitter Block Diagram

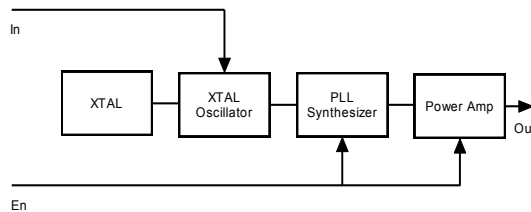

Transmitter Part Numbering

315MHz Transmitter Modules		433MHz Transmitter Modules		868MHz Transmitter Modules	
Part Number	Description	Part Number	Description	Part Number	Description
FM-RTFQ1-315P	DIL Module	FM-RTFQ1-433P	DIL Module	FM-RTFQ1-868P	DIL Module
FM-RTFQ1-315PSO	SMT Module	FM-RTFQ1-433PSO	SMT Module	FM-RTFQ1-868PSO	SMT Module
FM-RTFQ2-315P	SIL Module	FM-RTFQ2-433P	SIL Module	FM-RTFQ2-868P	SIL Module

Receiver Block Diagram

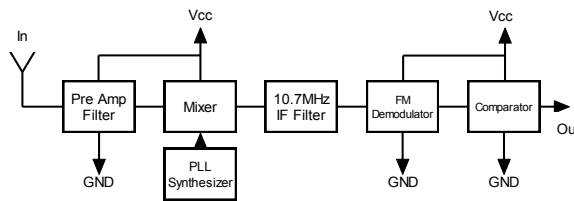

Receiver Part Numbering

315MHz Receiver Modules		433MHz Receiver Modules		868MHz Receiver Modules	
Part Number	Description	Part Number	Description	Part Number	Description
FM-RRFQ1-315P	SIL Module	FM-RTFQ2-433P	SIL Module	FM-RTFQ2-868P	SIL Module

FM Transmitter & Receiver Modules



RTFQ1 Mechanical Dimensions

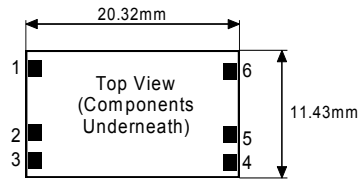
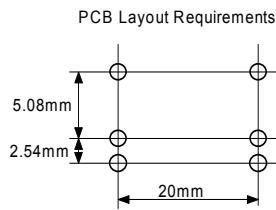

Module Thickness 2mm

Pins on *0.1 pitch
Pin Dimensions :
0.25mm x 0.50mm

RTFQ1 SMT Mechanical Dimensions

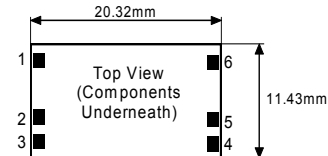
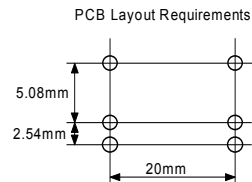

Module Thickness 2mm

Pins on *0.1 pitch
Pin Dimensions :
0.25mm x 0.50mm

RTFQ2 Mechanical Dimensions

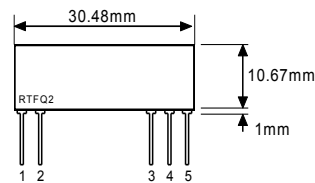
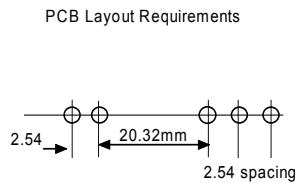

Module Thickness 2mm

Pins on *0.1 pitch
Pin Dimensions :
0.25mm x 0.50mm

Pin Description

RTFQ1	RTFQ2	Name	Description
1	N/A	En	Enable (active high)
2	5	IN	Data input
3	1	GND	Ground, Connect to RF earth return path
4	3	Vcc	Supply Voltage
5	4	GND	Ground, Connect to RF earth return path
6	2	EA	External Antenna

Technical Specifications RTFQ1P. RTFQ2P

Electrical Characteristics	MIN	TYPICAL	MAX	DIMENSION
Supply Voltage	2.1	3.3	4.00	V
Supply Current		7	8	mA
Standby Current (IN = EN = Low)			100	nA
Frequency		315.00 433.92 868.35		MHz
RF Output into 50W (Vcc=3.3V)		+5 / +5 / +1		dBm
Initial Frequency Accuracy	-35	0	+35	KHz
FM Deviation	25	30	35	KHz
Harmonic Spurious Emissions		-50		dBc
Input High Voltage RTFQ1	1.5		Vcc	V
Input High Voltage RTFQ2	1.5		5.5	V
Power up Time (En to full RF)			1	mS
Power up Time (Power on to full RF)			5	mS
Max Data Rate			9.6	KHz
Power up Time (Power on to full RF)			5	mS
Max Data Rate			9.6	Kbit/s
Operating Temperature	-20		+85	°C

FM Transmitter & Receiver Modules



RRFQ1 Mechanical Details

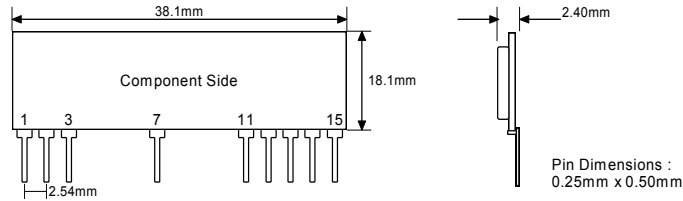

Pin Description

RRFQ1	Pin Description
1	+Vcc
2, 7, 11	GND
3	Data In (Antenna)
12	NC
13	Received Signal Strength Output
N/A	AF Output
14	Data Out
15	Power Down 0V = Standby 5V = Operating

RSSI Output*

RF In (dBm)	RSSI (V)
-120	1.20
-110	1.32
-100	1.50
-90	1.78
-80	2.06
-70	2.35
-60	2.62
-50	2.72
-40	2.75

RSSI Output

The RSSI provides a DC Voltage proportional to the peak value of the receive data signal. This output can be used as an indicator for the received signal strength to use in wake-up circuits etc.

An RC circuit is normally used to provide the timing for the RSSI signal. The modules have a 10nF capacitor internally connected to GND, therefore a pull down resistor (to GND) connected to the RSSI pin may be used to generate a simple RC network time constant for the RSSI signal output.

Please note that the maximum output current is typically 950 μ A, the discharge current is lower than 2 μ A

FM Transmitter & Receiver Modules



Technical Specifications

Electrical Characteristics	Min	Typical	Max	Dimension	Notes
Supply Voltage (Vcc)	4.5	5	5.5	V	
Supply Current (Operating)		5.7	6.8	mA	
Supply Current (Standby)			100	nA	
Receiver Frequency		315.00 433.92 868.35		MHz	
R.F Sensitivity 315 .433MHZ versions 868MHz versions		-103 -100		dBm	
3dB Bandwidth		+/-150		KHz	
Data Rate RRFQ1 CTC RRFQ1 /RRFQ2	300 300		9,600 4,800	Hz	
Turn on Time			5	mSecs	1
Turn on Time		8		mSecs	2
Level of Emitted Spectrum			-70	dBm	
Low Level Output Voltage			0.8	V	I = 200uA
High Level Output Voltage	Vcc-1			V	I = 200uA
RSSI Output		0.95		mA	
Operating Temperature Range	-25		+80	°C	

Notes

Time from PD pin going high to stable data. (RRFQ1 only)

Time from Power ON to stable data.

Prototyping Hints

It is essential when building any Low Power Radio System that you have a 'clean' DC power source. Typically the ripple voltage should be less than 10mV Peak to Peak. Normally a 470uF decoupling capacitor is sufficient de-coupling for an AC derived DC power source. Small capacitors of 10-100nF can also be used across the power supply to filter high frequency noise.

Never place a Transmitter or Receiver directly into Vero-Board or any similar prototyping board. This will severely restrict the range. Rather, use small lengths of wire from the prototyping board to the pins of the Transmitter or Receiver.

A useful antenna, for testing purposes, for both the Transmitter and Receiver on 433MHz is to use a piece of wire 17.3cm long (23.8cm at 315MHz) soldered directly to the antenna pin.

Data should be encoded before it is transmitted over a wireless link to ensure reliability and reduce the effect of interference and cross talk. A range of encoders IC's are available from RF Solutions, please refer to the RF Solutions website for further information.

FM Transmitter & Receiver Modules



Typical Application

The following circuits show a remote control system with 'self learning feature'. Please refer to datasheet DS600 for more information.

Transmitter Circuit

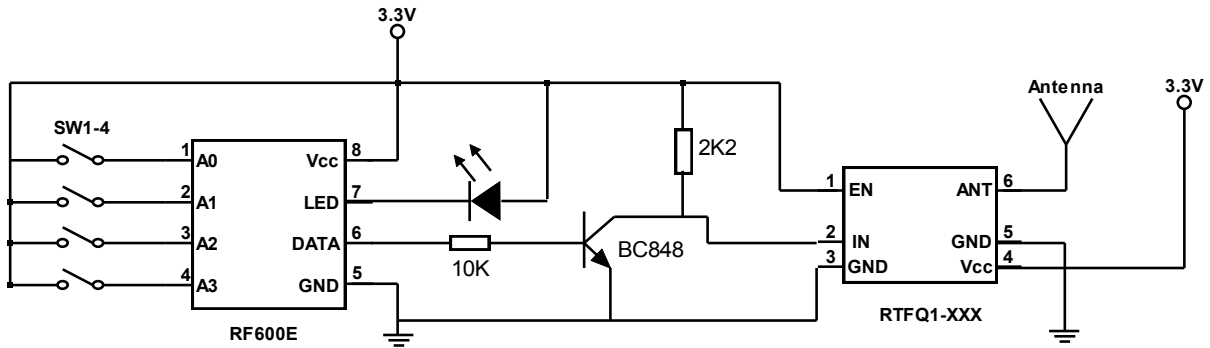

Receiver Circuit

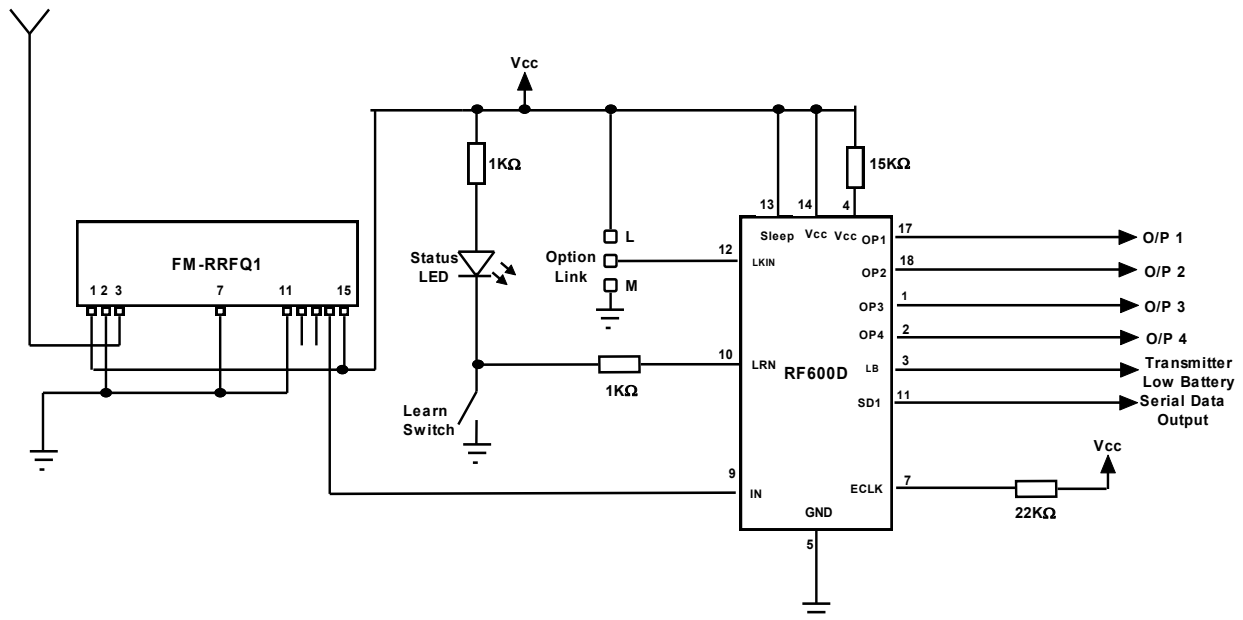

FM Transmitter & Receiver Modules



RF Solutions Ltd. Recycling Notice

Meets the following EC Directives:

DO NOT

Discard with normal waste, please recycle.



ROHS Directive 2002/95/EC

Specifies certain limits for hazardous substances.



WEEE Directive 2002/96/EC

Waste electrical & electronic equipment. This product must be disposed of through a licensed WEEE collection point. RF Solutions Ltd., fulfills its WEEE obligations by membership of an approved compliance scheme.

Waste Batteries and Accumulators Directive 2006/66/EC

Where batteries are fitted, before recycling the product, the batteries must be removed and disposed of at a licensed collection point.

Environment Agency producer registration number:

WEE/JB0104WV.

Disclaimer:

Whilst the information in this document is believed to be correct at the time of issue, RF Solutions Ltd does not accept any liability whatsoever for its accuracy, adequacy or completeness. No express or implied warranty or representation is given relating to the information contained in this document. RF Solutions Ltd reserves the right to make changes and improvements to the product(s) described herein without notice. Buyers and other users should determine for themselves the suitability of any such information or products for their own particular requirements or specification(s). RF Solutions Ltd shall not be liable for any loss or damage caused as a result of user's own determination of how to deploy or use RF Solutions Ltd's products. Use of RF Solutions Ltd products or components in life support and/or safety applications is not authorised except with express written approval. No licences are created, implicitly or otherwise, under any of RF Solutions Ltd's intellectual property rights. Liability for loss or damage resulting or caused by reliance on the information contained herein or from the use of the product (including liability resulting from negligence or where RF Solutions Ltd was aware of the possibility of such loss or damage arising) is excluded. This will not operate to limit or restrict RF Solutions Ltd's liability for death or personal injury resulting from its negligence.

www.rfsolutions.co.uk

RF Solutions Ltd

William Alexander House, William Way, Burgess Hill, West Sussex, RH15 9AG
Sales: +44(0)1444 227 910 Tech Support: +44(0)1444 227909

