

阅读申明

- 1.本站收集的数据手册和产品资料都来自互联网，版权归原作者所有。如读者和版权方有任何异议请及时告之，我们将妥善解决。
- 2.本站提供的中文数据手册是英文数据手册的中文翻译，其目的是协助用户阅读，该译文无法自动跟随原稿更新，同时也可能存在翻译上的不当。建议读者以英文原稿为参考以便获得更精准的信息。
- 3.本站提供的产品资料，来自厂商的技术支持或者使用者的心得体会等，其内容可能存在描述上的差异，建议读者做出适当判断。
- 4.如需与我们联系，请发邮件到marketing@iczoom.com，主题请标有“数据手册”字样。

Read Statement

1. The datasheets and other product information on the site are all from network reference or other public materials, and the copyright belongs to the original author and original published source. If readers and copyright owners have any objections, please contact us and we will deal with it in a timely manner.
2. The Chinese datasheets provided on the website is a Chinese translation of the English datasheets. Its purpose is for reader's learning exchange only and do not involve commercial purposes. The translation cannot be automatically updated with the original manuscript, and there may also be improper translations. Readers are advised to use the English manuscript as a reference for more accurate information.
3. All product information provided on the website refer to solutions from manufacturers' technical support or users the contents may have differences in description, and readers are advised to take the original article as the standard.
4. If you have any questions, please contact us at marketing@iczoom.com and mark the subject with "Datasheets" .

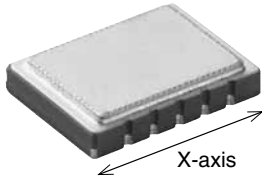

↔ : Direction of acceleration detection

FEATURES

1. High precision and high reliability:
Offset temperature characteristics
 $\pm 47\text{mg}$ (Typical value)
2. High sensitivity: 1 to 1.333V/g
(VDD=5V)

TYPICAL APPLICATIONS

- Car navigation system
- Projectors (trapezoidal compensation)
- Elevators, Medical caregiving devices (inclination detection)

Compliance with RoHS Directive

ORDERING INFORMATION

AGS 1 1 5 1

Number of detectable axis (Method)

1: 1-axis Acceleration Sensor (Electrostatic capacitance type)

Package type/Size

1: Ceramic package/6.2 x 8.5 mm

Detection sensitivity

1: 1 V/g

3: 1.333 V/g

Operation power supply voltage/Output type

5: 5 V DC/Analog output

Type

1: Built-in ASIC

TYPES

Product name	Operation power supply voltage	Acceleration detection range	Detection sensitivity	Part number
1-axis Acceleration sensor GS1	5V DC	$\pm 2\text{g}$	1V/g	AGS11151
		$\pm 1.5\text{g}$	1.333V/g	New AGS11351

Standard packing: Carton: 1,000 pcs.

MAXIMUM RATING

Item	Unit	Standard value			Remarks
		min.	typ.	max.	
Max. applied voltage	V	-0.3	—	7	Ta=25°C 77°F
Storage temperature range	°C °F	-40 -40	—	85 185	
Operation temperature range	°C °F	-40 -40	—	85 185	
Anti-shock characteristic	g	5,000	—	—	

GS1 Sensor (AGS1)

ELECTRICAL CHARACTERISTICS

Item	Unit	Standard value						Remarks
		min.		typ.		max.		
		AGS11151	AGS11351	AGS11151	AGS11351	AGS11151	AGS11351	
Acceleration detection range ^{Note 1)}	g	-2	-1.5	—		2	1.5	
Operation power supply voltage	V	4.75		5		5.25		-40 to +85°C -40 to +185°F
Current consumption	mA	—		5		7		0g, Ta=25°C 77°F
Sensitivity	V/g	0.97	1.293	1	1.333	1.03	1.373	Ta=25°C 77°F
Offset voltage (0 g)	V	2.4		2.5		2.6		Ta=25°C 77°F
Temperature sensitivity characteristic	%	-4		—		4		-40 to +85°C -40 to +185°F
Offset voltage temperature characteristic	mg	-70		—		70		-40 to +85°C -40 to +185°F
Other axis sensitivity ^{Note 2)}	%	-5		—		5		Ta=25°C 77°F
Non-linearity ^{Note 3)}	%FS	-1		—		1		Ta=25°C 77°F
Turn-on time ^{Note 4)}	ms	—		10		—		0g, Ta=25°C 77°F C1=220nF, C2=27nF
Frequency response ^{Note 5)}	Hz	DC		60		—		-3dB point, C2=27nF

Notes: 1. The acceleration unit "g" means 9.8 m/s².

2. VDD=5 V when there is no indication.

3. Maximum error from linear output that connects +2 g and -2 g output.

4. "C1" is a ceramic capacitor installed between the VDD and GND terminals. "C2" is a ceramic capacitor installed between the Vout and Ext-Cap terminals.

5. The frequency characteristics can be changed depending on the C2 capacitance value. Please refer to "Recommended circuit diagram" on the following page. Note that the maximum frequency response is 200 Hz.

REFERENCE DATA

1. Output characteristics

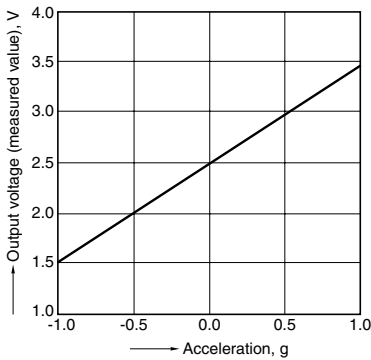

2. Inclination angle - Output voltage characteristics

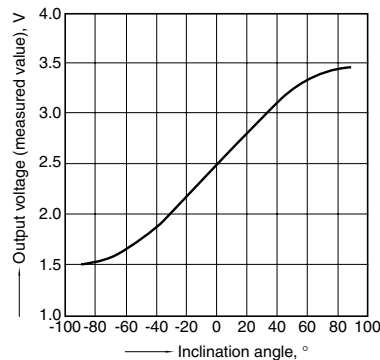

3. Sensitivity temperature characteristics (VDD=5V)

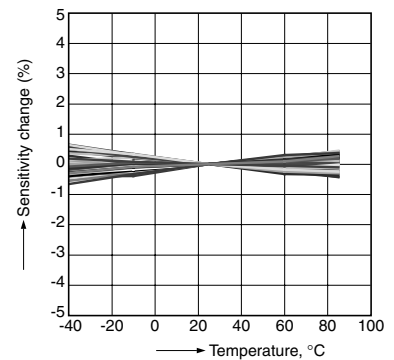

4. Offset voltage temperature characteristics (VDD=5V)

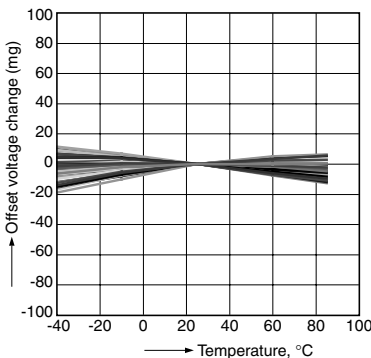

5. Frequency characteristics

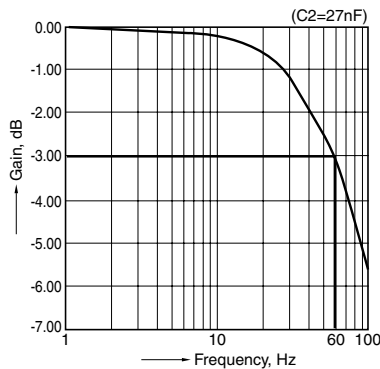

Note: The frequency characteristics can be changed depending on the C2 capacitance value. Please refer to "Recommended circuit diagram" on the following page.

DIMENSIONS (mm inch)

The CAD data of the products with a **CAD Data** mark can be downloaded from: <http://panasonic-electric-works.net/ac>

CAD Data

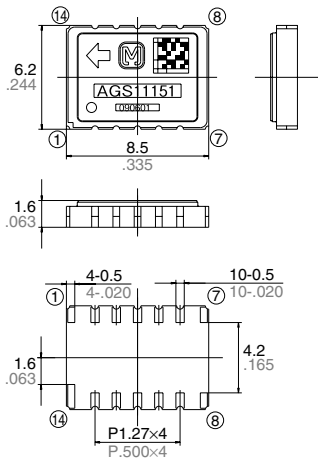

Terminal layout			
①	NC	⑧	NC
②	GND	⑨	VDD
③	NC	⑩	NC
④	Vout	⑪	NC
⑤	Ext-Cap	⑫	NC
⑥	GND	⑬	NC
⑦	NC	⑭	NC

Leave terminal "NC (No. 1, 3, 7, 8 and 10 to 14)" unconnected.
The No. 2 and No. 6 terminals are connected internally.

Tolerance: ±0.2 ±.008

Recommended PC board pad

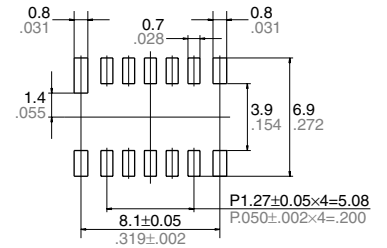

RECOMMENDED CIRCUIT DIAGRAM

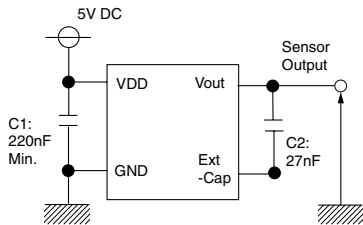

The frequency characteristics value can be changed depending on the C2 capacitance value.
-3dB bandwidth is expressed in the formula below.

$$f_{-3dB} = \frac{1}{2\pi \times (100k\Omega) \times C2}$$

PACKING FORMAT (Tape and reel) (mm inch)

Tape dimensions

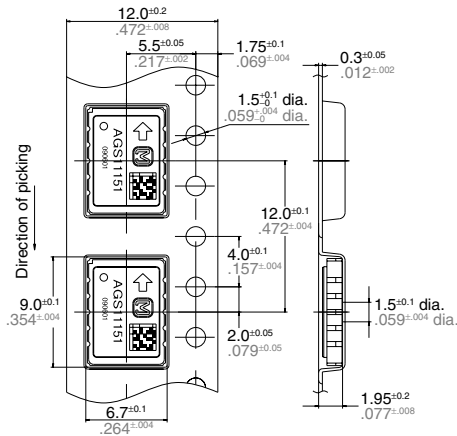

Dimensions of tape reel

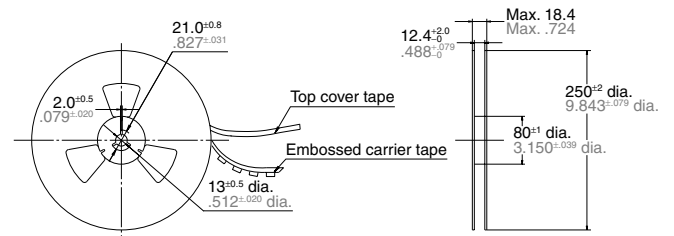

GS2 Sensor (AGS2)/GS1 Sensor (AGS1)

NOTES

1. To ensure reliability, please verify quality under conditions of actual use.

2. Mounting

Use lands on the PC boards to which the sensor can be securely fixed.

- Malfunctioning may occur if much noise is present in the power supply used for this product. In order to prevent, in particular, superimposed noise, please install the recommended capacitor between the sensor input terminals (between VDD and GND) closest to the sensor (a position within 20 mm of the pattern circuit length). However, please reselect an ideal capacitor after performing tests on the actual equipment.
- Since the top surface (where the part number is visible) of the sensor is GND, please make sure that the metallic parts of other components do not come into contact.

3. Soldering

- Take steps to minimize the effects of external heat. Damage and changes to characteristics may occur due to heat deformation.

- Use a non-corrosive resin type of flux.

1) Manual soldering

- Set the soldering tip from 350 to 400°C 662 to 752°F (30 to 60W), and solder for no more than 3 seconds.

- Please note that output may change if the pressure is applied on the terminals when the soldering.

- Thoroughly clean the soldering iron.

2) Reflow soldering

- The recommended reflow temperature profile conditions are given below.
- We recommend the screen solder printing method as the method for cream solder printing.

- Please refer to the recommended PC board pad for the PC board foot pattern.
- Self alignment may not always work as expected; therefore, please carefully adjust the position of the terminals and pattern.

- The profile temperature is the value measured on the PC board near the terminals.
- When doing reflow soldering on the back of the PC board after performing sensor reflow, please fix the sensor with adhesive and so on.

- When doing reflow soldering on the back of the PC board after performing sensor reflow, please fix the sensor with adhesive and so on.

3) Solder reworking

- Finish reworking in one operation.
- For reworking of the solder bridge, use a soldering iron with a flat tip. Please do not add more flux when reworking.
- Please use a soldering iron that is below the temperature given in the specifications in order to maintain the correct temperature at the tip of the soldering iron.

4) Too much temperature on the terminals will cause deformation and loss in effectiveness of the solder. Therefore, please avoid dropping and careless handling of the product.

5) When cut folding the PC board after mounting the sensor, take measures to prevent stress to the soldered parts.

6) The sensor terminals are designed to be exposed, so contact of the terminals with metal shards and the like will cause output errors. Therefore, please be careful and prevent things such as metal shards and hands from contacting the terminals.

7) To prevent degradation of the PC board insulation after soldering, please be careful not to get chemicals on the sensor when coating.

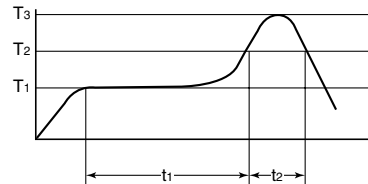

T₁ = 150 to 180°C 302 to 356°F
T₂ = 230°C 446°F
T₃ = Max. 250°C 482°F
t₁ = 60 to 120 sec.
t₂ = With in 30 sec.

4. Connections

- Please perform connections correctly in accordance with the terminal connection diagram. In particular, be careful not to reverse wire the power supply as this will cause damage or degrade to the product.
- Do not connect "NC" terminals that are not used. This can cause malfunction of the sensor.

5. Cleaning

- Avoid ultrasonic cleaning since this may cause breaks or disconnections in the wiring.

6. Environment

- Please avoid using or storing the sensor in a place exposed to corrosive gases (such as the gases given off by organic solvents, sulfuric acid gas, hydrogen sulfides, etc.) which will adversely affect the performance of the sensor.
- When installing the sensor, you must provide a capacitor as shown in the recommended circuit diagram.
- Since the internal circuitry may be destroyed if an external surge voltage is supplied, provide an element which will absorb the surges.
- Malfunctioning may occur if the product is in the vicinity of electrical noise such as that from static electricity, lightning, a broadcasting station, an amateur radio, or a mobile phone.

- Please do not use the sensor in a location where it may be sprayed with water, etc.

- Avoid using the sensor in an environment where condensation may form.

Furthermore, its output may fluctuate if any moisture adhering to it freezes.

- Avoid using the sensor where it will be susceptible to ultrasonic or other high-frequency vibration.

7. Other handling precautions

To assure reliability, check the sensor under actual loading conditions. Avoid any situation that may adversely affect its performance.

- This product may malfunction if dropped on its own before it is installed. Do not use if this happens.

- Caution is required because differences in the acceleration detection range and the method of connection can lead to accidents.

- The actual acceleration should be within the rated acceleration range. Damage may occur if it is outside of this range.

- This product may become damaged if exposed to static electricity. Therefore, please be careful, as follows, when handling.

(1) Since plastic containers easily hold a charge, please do not use them for storage or transport.

(2) Please store or transport the product in an environment that hinders the occurrence of static electricity (for example, places with 45% to 60% humidity) and protect the product using electrically conductive packaging.

(3) Implement static electricity prevention measures once the product packaging has been opened.

- Any personnel handling the sensor should wear electrostatic clothing and be body grounded.

- Place an electrically conducting board on the work surface and ground any devices used such as measuring instruments and jigs.

- Use a soldering iron with a low leak current or else ground the tip.

- Make sure that customer equipment used for device assembly is grounded.

(4) Since the internal circuitry may be destroyed if an external surge voltage is supplied, provide an element which will absorb the surges. (Surge toleration: power supply voltage of absolute maximum rating)