

阅读申明

- 1.本站收集的数据手册和产品资料都来自互联网，版权归原作者所有。如读者和版权方有任何异议请及时告之，我们将妥善解决。
- 2.本站提供的中文数据手册是英文数据手册的中文翻译，其目的是协助用户阅读，该译文无法自动跟随原稿更新，同时也可能存在翻译上的不当。建议读者以英文原稿为参考以便获得更精准的信息。
- 3.本站提供的产品资料，来自厂商的技术支持或者使用者的心得体会等，其内容可能存在描述上的差异，建议读者做出适当判断。
- 4.如需与我们联系，请发邮件到marketing@iczoom.com，主题请标有“数据手册”字样。

Read Statement

1. The datasheets and other product information on the site are all from network reference or other public materials, and the copyright belongs to the original author and original published source. If readers and copyright owners have any objections, please contact us and we will deal with it in a timely manner.
2. The Chinese datasheets provided on the website is a Chinese translation of the English datasheets. Its purpose is for reader's learning exchange only and do not involve commercial purposes. The translation cannot be automatically updated with the original manuscript, and there may also be improper translations. Readers are advised to use the English manuscript as a reference for more accurate information.
3. All product information provided on the website refer to solutions from manufacturers' technical support or users the contents may have differences in description, and readers are advised to take the original article as the standard.
4. If you have any questions, please contact us at marketing@iczoom.com and mark the subject with "Datasheets" .

HEDL-550x/554x, HEDL-560x/564x, HEDL-9000/9100, HEDL-9040/9140/ 92xx Encoder Line Drivers



Data Sheet



Description

Line Drivers are available for the HEDS-55xx/56xx series and the HEDS-9000/9100/9200/9040/9140 series encoders. The line driver offers enhanced performance when the encoder is used in noisy environments, or when it is required to drive long distances.

The encoder line driver utilizes an industry standard line driver IC, AM26C31Q, which provides complementary outputs for each encoder channel. Thus, the output of the line driver encoder is A, \bar{A} , B, \bar{B} and I/ \bar{I} for three channel versions. Suggested line receivers are 26LS32 and 26LS33.

For additional information, please refer to:

HEDS-5500/5540/5600/5640 data sheet,

HEDS-90x0/91x0/92x0 data sheets,

HEDS-9000 series extended resolution data sheet, and AM26C31Q data sheet.

Features

- Available on Both Encoder Modules (HEDS-9000 Series) and Encoder Kit Housing (HEDS-5500 Series)
- Complementary Outputs
- Industry Standard Line Driver IC
- Single 5 V Supply
- Onboard Bypass Capacitor

Note: Avago Technologies encoders are not recommended for use in safety critical applications. Eg. ABS braking systems, power steering, life support systems and critical care medical equipment. Please contact sales representative if more clarification is needed.

Device Characteristics

Parameter	Characteristic	Notes
Termination	10 conductor ribbon cable with 10 position IDC connector	See pinout
Electrical Outputs	Complementary outputs: A, \bar{A} , B, \bar{B} , I, \bar{I}	I and \bar{I} available only on three channel encoders
Line Driver Components	AM26C31Q line driver IC, decoupling capacitor on PC board.	
Operating Temperature Range	-40°C to 100° C	100° C Series
Storage Temperature	-40°C to 100° C	100° C Series

ESD WARNING: NORMAL HANDLING PRECAUTIONS SHOULD BE TAKEN TO AVOID STATIC DISCHARGE.

Line Driver Package Dimensions

For Detailed Dimensions on encoder packages, please refer to the respective data sheets.

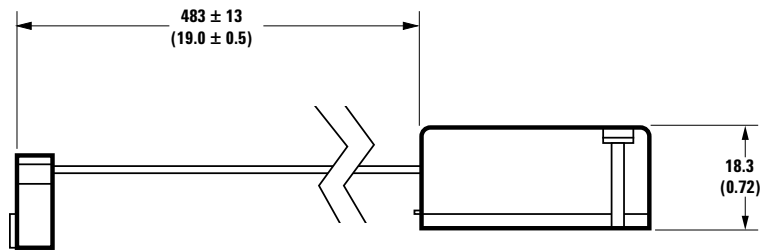
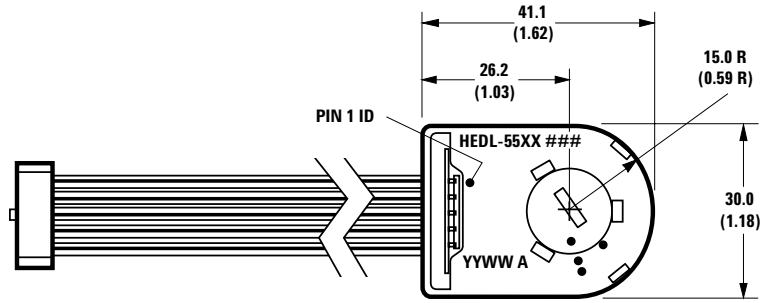

HEDL-550X/554X/560X/564X

NOTE: DIMENSIONS IN MILLIMETERS (INCHES)

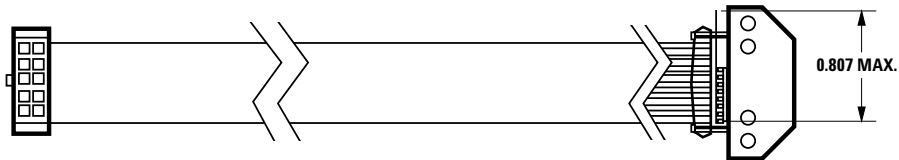
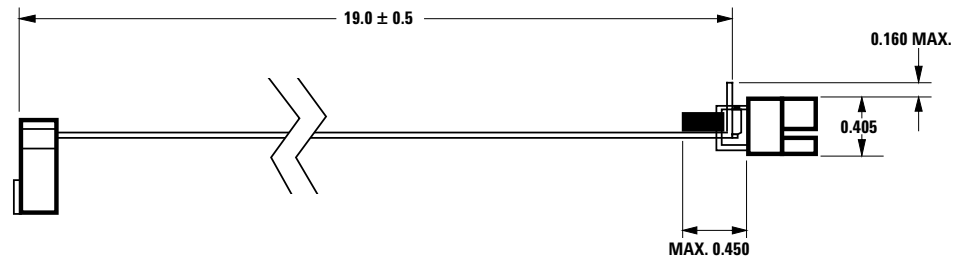

HEDL-9000/9100/9200/9040/9140

Waveforms

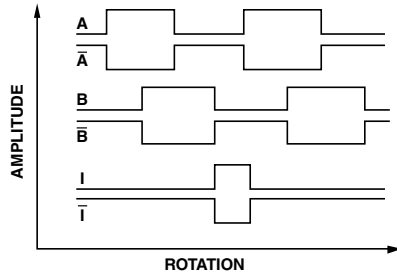

Block Diagram

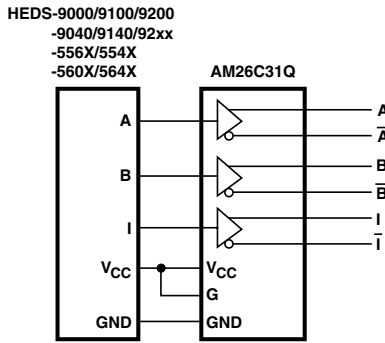

Pinouts

10-PIN CONNECTOR

NO.	COLOR	PARAMETER
1	BROWN	NC
2	RED	V _{CC} (+ 5 V)
3	ORANGE	GND
4	YELLOW	NC
5	GREEN	A̅
6	BLUE	A
7	VIOLET	B̅
8	GREY	B
9	WHITE	I̅ (INDEX)
10	BLACK	I (INDEX)

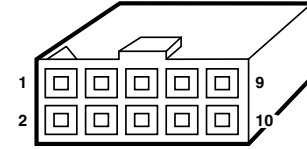

10 POSITION IDC CONNECTOR
CENTER POLARIZED.

Note: I̅ only available on three channel encoders.

Line Driver Base Parts Available:

100°C Line Driver Base Part	Channels	Refer to the following encoder data sheet for additional information and option codes (XXX = resolution and/or shaft size)
HEDL-5500#XXX	A, B	HEDS-5500#XXX
HEDL-5505#XXX	A, B	HEDS-5505#XXX
HEDL-5540#XXX	A, B, I	HEDS-5540#XXX
HEDL-5600#XXX	A, B	HEDS-5600#XXX
HEDL-5605#XXX	A, B	HEDS-5605#XXX
HEDL-5640#XXX	A, B, I	HEDS-5640#XXX
HEDL-5645#XXX	A, B, I	HEDS-5645#XXX
HEDL-9000#XXX	A, B	HEDS-9000#XXX
HEDL-9040#XXX	A, B, I	HEDS-9040#XXX
HEDL-9100#XXX	A, B	HEDS-9100#XXX
HEDL-9140#XXX	A, B, I	HEDS-9140#XXX

Ordering Information:

For option code selection, refer to the data sheet for the corresponding “HEDS” part number (see right column).

		01	02	04	05	06	11	12	13	14
HEDL-5500#	A		*			*				
	E					*				
	G				*			*		
	H					*				
	I			*						
HEDL-5505#	A					*				
	I								*	
HEDL-5540#	A	*	*		*	*	*	*	*	*
	C		*		*			*		
	E					*	*			
	G						*			
	I	*				*	*		*	
HEDL-5600#	A					*				
	H					*				
HEDL-5605#	A					*				
	C									*
HEDL-5640#	A					*	*	*		
HEDL-5645#	A					*			*	
	G					*				

HEDL-9000#	U00
HEDL-9040#	B00
HEDL-9100#	A00
HEDL-9140#	A00 I00

For product information and a complete list of distributors, please go to our web site: www.avagotech.com

Avago, Avago Technologies, and the A logo are trademarks of Avago Technologies, Limited in the United States and other countries.
 Data subject to change. Copyright © 2006 Avago Technologies Pte. All rights reserved. Obsoletes 5989-4105EN
 AV02-0993EN - January 30, 2008

