

阅读申明

- 1.本站收集的数据手册和产品资料都来自互联网，版权归原作者所有。如读者和版权方有任何异议请及时告之，我们将妥善解决。
- 2.本站提供的中文数据手册是英文数据手册的中文翻译，其目的是协助用户阅读，该译文无法自动跟随原稿更新，同时也可能存在翻译上的不当。建议读者以英文原稿为参考以便获得更精准的信息。
- 3.本站提供的产品资料，来自厂商的技术支持或者使用者的心得体会等，其内容可能存在描述上的差异，建议读者做出适当判断。
- 4.如需与我们联系，请发邮件到marketing@iczoom.com，主题请标有“数据手册”字样。

Read Statement

1. The datasheets and other product information on the site are all from network reference or other public materials, and the copyright belongs to the original author and original published source. If readers and copyright owners have any objections, please contact us and we will deal with it in a timely manner.
2. The Chinese datasheets provided on the website is a Chinese translation of the English datasheets. Its purpose is for reader's learning exchange only and do not involve commercial purposes. The translation cannot be automatically updated with the original manuscript, and there may also be improper translations. Readers are advised to use the English manuscript as a reference for more accurate information.
3. All product information provided on the website refer to solutions from manufacturers' technical support or users the contents may have differences in description, and readers are advised to take the original article as the standard.
4. If you have any questions, please contact us at marketing@iczoom.com and mark the subject with "Datasheets" .

FEATURES

1. Built-in optical filter for spectral response similar to that of the human eye.

Peak sensitivity wavelength is 580 nm

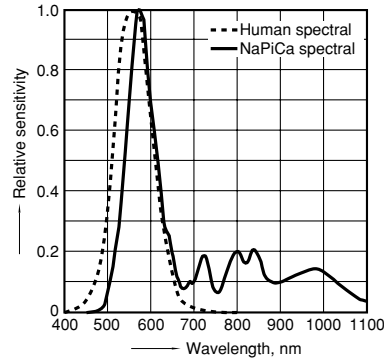

2. Photocurrent is proportional to illumination. (linear output)

High photocurrent is achieved by built-in photocurrent amp.

$I_L = 260 \mu A$ (typical)

$E_v = 100 \text{ lx}$ (fluorescent light)

3. Uses environmentally friendly silicon chips.

4. Lead-free.

5. Operates on 1.5 to 6 V DC, which is suitable for battery operation.

6. Compact, SMD package

TYPICAL APPLICATIONS

1. Brightness detection for LCD backlight control for LCD devices (mobile phones, LCD TVs, car navigation systems, mobile PCs, and PDAs).

2. Brightness detection for circuits in household lighting, crime prevention lighting, and automatic lighting for bicycle.

3. Brightness detection for controlling the keypad backlight in mobile phones.

4. Brightness detection for surveillance cameras (night switching).



L 2.0mm .079inch
W 3.2mm .126inch
H 1.0mm .039inch

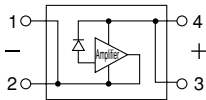

TYPES

Packing quantity: 3,000pcs.

Output rating	Part No.	
	Picked from the 1/4-pin side	Picked from the 2/3-pin side
260 μA *	AMS104Y	AMS104W

Note: $E_v = 100 \text{ lx}$ (Fluorescent lamp is used as light source)
Tape package is the standard packing style.

Ratings

1. Absolute maximum ratings (Ambient temperature: 25°C 77°F)

Item	Symbol	AMS104	Remarks
Reverse voltage	V_R	-0.5 to 8 V	
Photocurrent	I_L	5 mA	
Power dissipation	P	40 mW	
Operating temperature	T_{opr}	-30 to +85°C -22 to +185°F	Non-condensing at low temperatures
Storage temperature	T_{stg}	-40 to +100°C -40 to +176°F	Non-condensing at low temperatures

2. Recommended operating condition

Item	Symbol	AMS104	Remarks
Reverse voltage	Minimum	1.5 V	—
	Maximum	6 V	

3. Electrical characteristics (Ambient temperature: 25°C 77°F)

Item	Symbol	AMS104	Condition	
Peak sensitivity wavelength	λ_p	580 nm	—	
Photocurrent 1	Minimum	9.1 μA	$V_R = 5\text{ V}$ $E_v = 5\text{ lx}^{*1}$	
	Typical	13 μA		
	Maximum	16.9 μA		
Photocurrent 2	Minimum	182 μA	$V_R = 5\text{ V}$ $E_v = 100\text{ lx}^{*1}$	
	Typical	260 μA		
	Maximum	338 μA		
Photocurrent 3	Typical	500 μA	$V_R = 5\text{ V}$ $E_v = 100\text{ lx}^{*2}$	
Dark current	Maximum	I_D	0.3 μA $V_R = 5\text{ V}$	
Switching time	Rise time	Typical	t_r	8.5 ms $V_R = 2.5\text{ V}$, $V_O = 2.5\text{ V}$ $R_L = 5\text{ k}\Omega$
	Fall time	Typical	t_f	

*1 Fluorescent lamp is used as light source.

*2 CIE standard illuminant 'A' is used as light source.

*3 Measuring method for switching time.

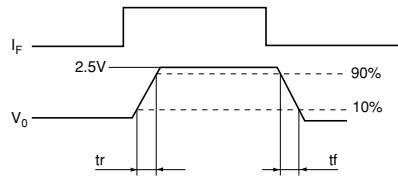
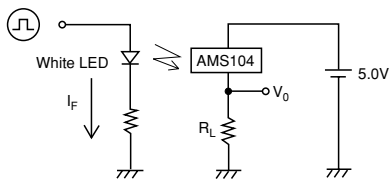

REFERENCE DATA

1. Power dissipation vs. ambient temperature characteristics

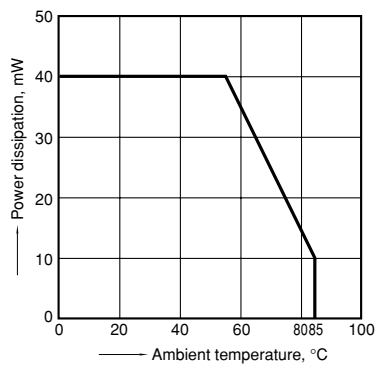

2. Relative sensitivity vs. wavelength characteristics

Ambient temperature: 25°C 77°F

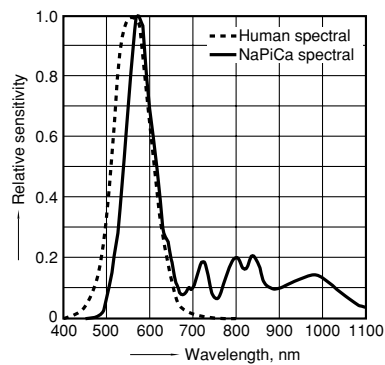

3. Dark current vs. ambient temperature characteristics

Reverse voltage: 5V

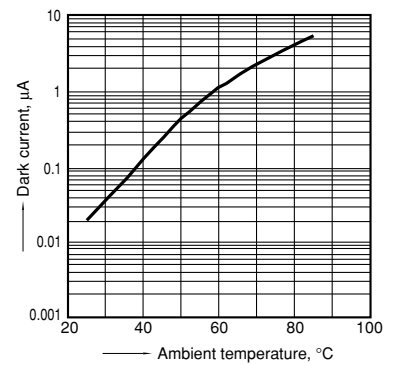

4. Photocurrent vs. brightness characteristics

Light source: Fluorescent lamp, CIE standard "A"
Reverse voltage: 5V, Ambient temperature: 25°C 77°F

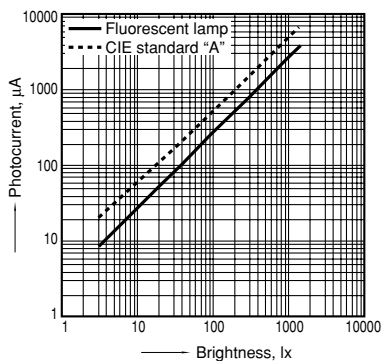

5. Relative photocurrent vs. ambient temperature characteristics

Light source: Fluorescent lamp, Brightness: 100 lx
Reverse voltage: 5V

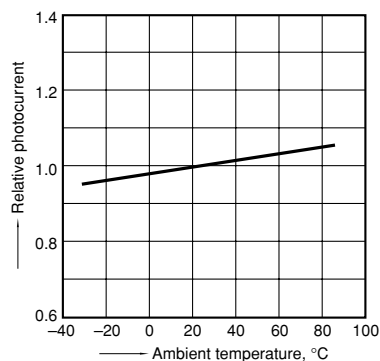

6. Relative photocurrent vs. reverse voltage characteristics

Light source: Fluorescent lamp, Brightness: 100 lx
Ambient temperature: 25°C 77°F

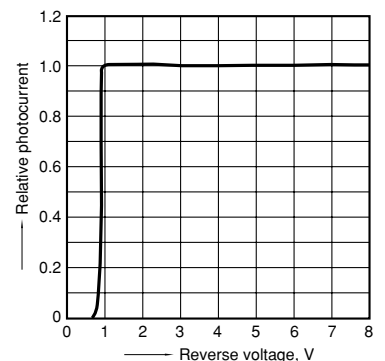

CAUTIONS FOR USE

1. Applying stress that exceeds the absolute maximum rating

If the voltage or current value for any of the terminals exceeds the absolute maximum rating, internal elements will deteriorate because of the excessive voltage or current. In extreme cases, wiring may melt, or silicon P/N junctions may be destroyed.

As a result, the design should ensure that the absolute maximum ratings will never be exceeded, even momentarily.

2. Deterioration and destruction caused by discharge of static electricity

This phenomenon is generally called static electricity destruction, and occurs when static electricity generated by various factors is discharged while the relay terminals are in contact, producing internal destruction of the element. To prevent problems from static electricity, the following precautions and measures should be taken when using your device.

1) Employees handling sensor should wear anti-static clothing and should be grounded through protective resistance of 500 kΩ to 1 MΩ.

2) A conductive metal sheet should be placed over the work table. Measuring instruments and jigs should be grounded.

3) When using soldering irons, either use irons with low leakage current, or ground the tip of the soldering iron. (Use of low-voltage soldering irons is also recommended.)

4) Devices and equipment used in assembly should also be grounded.

5) When packing printed circuit boards and equipment, avoid using high-polymer materials such as foam styrene, plastic, and other materials which carry an electrostatic charge.

6) When storing or transporting sensor, the environment should not be conducive to generating static electricity (for instance, the humidity should be between 45 and 60%), and sensor should be protected using conductive packing materials.

3. When powered on, please note that current flow in the sensor will fluctuate for the purpose of internal circuit stability.

4. Storage

The sensors are compact, transparent, plastic packages. They are sensitive to moisture and come in sealed, moisture-proof packages. Observe the following cautions when storing.

1) After the moisture-proof package is unsealed, take the devices out of storage as soon as possible (within 1 week at the

most).

2) If the devices are to be left in storage for a considerable period after the moisture-proof package has been unsealed, it is recommended to keep them in another moisture-proof bag containing silica gel (within 3 months at the most).

3) Storage under extreme conditions will cause soldering degradation, external appearance defects, and deterioration of the characteristics. The following storage conditions are recommended:

- Temperature: 0 to 30°C 32 to 86°F
- Humidity: Less than 60% R.H.
- Atmosphere: No harmful gasses such as sulfurous acid gas, minimal dust.

*When mounting with solder, if thermal stress is applied to sensors that have absorbed moisture, the moisture will vaporize, swelling will occur, and the inside of the package will become stressed. This may cause the package surface to blister or crack. Therefore, please take caution and observe the soldering conditions in the following section.

5. Recommended soldering conditions

1) Recommended condition 1: (Recommended solder composition: Sn3.0Ag0.5Cu) If using SnPb eutectic solder, please refer to "Recommended condition 2" in section 2), below.

(1) IR (Infrared reflow) soldering method

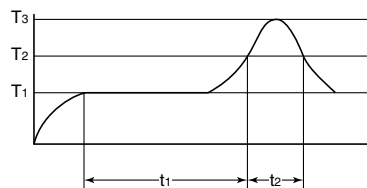

$T_1 = 155$ to 180°C 311 to 356°F

$T_2 = 230^\circ\text{C}$ 446°F

$T_3 = 250^\circ\text{C}$ 482°F or less

$t_1 = 60$ to 120 s or less

$t_2 = 30$ s or less

(2) Soldering iron method
Tip temperature: 350 to 400°C 662 to 752°F

Wattage: 30 to 60 W

Soldering time: within 3 s

2) Recommended condition 2: (Recommended solder composition: SnPb eutectic)

(1) IR (Infrared reflow) soldering method

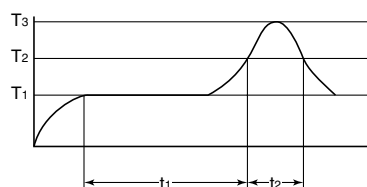

$T_1 = 155$ to 165°C 311 to 329°F

$T_2 = 180$ to 200°C 356 to 392°F

$T_3 = 245^\circ\text{C}$ 473°F or less

$t_1 = 120$ s or less

$t_2 = 30$ s or less

(2) Soldering iron method

Tip temperature: 280 to 300°C 536 to 572°F

Wattage: 30 to 60 W

Soldering time: within 5 s

3) Do not do flow soldering.

6. Notes for mounting

1) If many different packages are combined on a single substrate, then lead temperature rise is highly dependent on package size. For this reason, please make sure that the temperature of the terminal solder area of the Light sensor falls within the temperature conditions of item 9 before mounting.

2) If the mounting conditions exceed the recommended solder conditions in item 9, resin strength will fall and the nonconformity of the heat expansion coefficient of each constituent material will increase markedly, possibly causing cracks in the package, severed bonding wires, and the like. For this reason, please inquire with us about whether this use is possible.

7. Cleaning solvents compatibility

We recommend cleaning with an organic solvent. If you cannot avoid using ultrasonic cleansing, please ensure that the following conditions are met, and check beforehand for defects.

• Frequency: 27 to 29 kHz

• Ultrasonic output:

No greater than $0.25\text{W}/\text{cm}^2$

• Cleaning time:

No longer than 30 s

• Cleanser used: Asahiklin AK-225

• Other:

Submerge in solvent in order to prevent the PCB and elements from being contacted directly by the ultrasonic vibrations.

Note: Applies to unit area ultrasonic output for ultrasonic baths.

8. Transportation

Extreme vibration during transport will warp the lead or damage the sensor. Handle the outer and inner boxes with care.

9. Avoid using the sensor in environments containing excessive amounts of steam, dust, corrosive gas, or where organic solvents are present.

Light Sensor (AMS1)

10. The following shows the packaging format

1) Tape and reel

mm inch

Type	Tape dimensions	Dimensions of paper tape reel
Light sensor	<p>(1) When picked from 1 and 4-pin side: Part No. AMS104Y (Shown above) (2) When picked from 2 and 3-pin side: Part No. AMS104W</p>	

NaPiCa light sensor terminology

Term	Symbol	Explanation
Reverse voltage	V_R	The applied voltage between the cathode and anode.
Photocurrent	I_L	The current that flows between the cathode and anode when light is applied.
Power dissipation	P	The electric power loss that occurs between the cathode and anode.
Operating temperature	T_{opr}	The workable ambient temperature range at which normal operation is possible under the condition of a prescribed allowable loss.
Storage temperature	T_{stg}	The ambient temperature range at which the sensor can be left or stored without applying voltage.
Peak sensitivity wavelength	λ_p	The wavelength of light at which sensitivity is at its maximum.
Dark current	I_D	The current between the cathode and anode when reverse voltage is applied during darkness.
Rise time	t_r	Time required for the output waveform to rise from 10% to 90% when light is applied.
Fall time	t_f	Time required for output waveform to lower from 90% to 10% when light is cut.

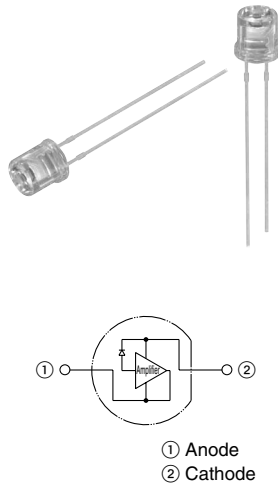

FEATURES

1. Built-in optical filter for spectral response similar to that of the human eye.

Peak sensitivity wavelength is 580 nm

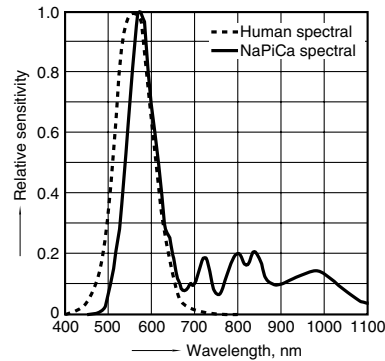

2. Photocurrent is proportional to illumination. (linear output)

High photocurrent is achieved by built-in photocurrent amp.

$I_L = 260 \mu\text{A}$ (typical)

$E_v = 100 \text{ lx}$ (florescent light)

3. Uses environmentally friendly silicon chips.

4. Lead-free.

5. Operates on 1.5 to 6 V DC, which is suitable for battery operation.

6. Same through-hole shape as CdS cell.

TYPICAL APPLICATIONS

- Brightness detection for LCD backlight control for LCD devices (LCD TVs, car navigation systems, etc.)
- Brightness detection for circuits in household lighting, crime prevention lighting, and automatic lighting for bicycle.
- Brightness detection for wall clocks (radio clocks).
- Brightness detection for surveillance cameras (night switching).

TYPES

Photocurrent	Part No.	Packing quantity
260 μA *	AMS302T	2,000pcs.

Note: $E_v = 100 \text{ lx}$ (Fluorescent lamp is used as light source)
Tape package is the standard packing style.

RATINGS

1. Absolute maximum ratings (Ambient temperature: 25°C 77°F)

Item	Symbol	AMS302	Remarks
Reverse voltage	V_R	-0.5 to 8 V	—
Photocurrent	I_L	5 mA	—
Power dissipation	P	40 mW	—
Operating temperature	T_{opr}	-30 to +85°C -22 to +185°F	Non-condensing at low temperatures
Storage temperature	T_{stg}	-40 to +100°C -40 to +176°F	Non-condensing at low temperatures

2. Recommended operating condition

Item	Symbol	AMS302	Remarks
Reverse voltage	Minimum	1.5 V	—
	Maximum	6 V	

Light Sensor (AMS3)

3. Electrical characteristics (Ambient temperature: 25°C 77°F)

Item		Symbol	AMS302	Condition
Peak sensitivity wavelength	—	λ_p	580 nm	—
Photocurrent 1	Minimum	I_{L1}	9.1 μA	$V_R = 5 \text{ V}, E_v = 5 \text{ lx}^{-1}$
	Typical		13 μA	
	Maximum		16.9 μA	
Photocurrent 2	Minimum	I_{L2}	182 μA	$V_R = 5 \text{ V}, E_v = 100 \text{ lx}^{-1}$
	Typical		260 μA	
	Maximum		338 μA	
Photocurrent 3	Typical	I_{L3}	500 μA	$V_R = 5 \text{ V}, E_v = 100 \text{ lx}^{-2}$
Dark current	Maximum	I_D	0.3 μA	$V_R = 5 \text{ V}$
Switching time	Rise time	Typical	t_r	$V_R = 2.5 \text{ V}, V_O = 2.5 \text{ V}, R_L = 5 \text{ k}\Omega$
	Fall time	Typical	t_f	

*1 Fluorescent lamp is used as light source. (Substituted with white LED for testing before shipping.)

*2 CIE standard illuminant 'A' is used as light source.

* Measuring method for switching time.

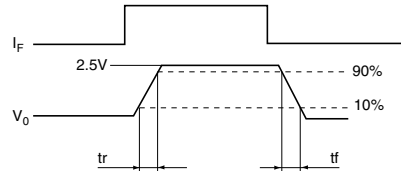
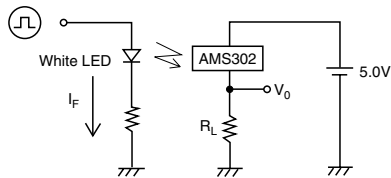

REFERENCE DATA

1. Power dissipation vs. ambient temperature characteristics

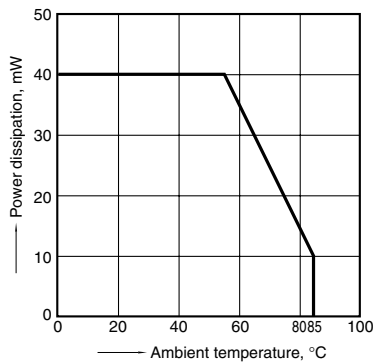

2. Relative sensitivity vs. wavelength characteristics

Ambient temperature: 25°C 77°F

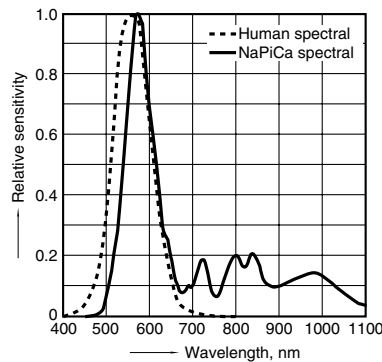

3. Dark current vs. ambient temperature characteristics

Reverse voltage: 5V

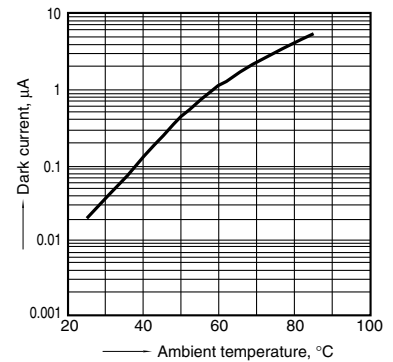

4. Photocurrent vs. brightness characteristics

Light source: Fluorescent lamp, CIE standard "A"
Reverse voltage: 5V, Ambient temperature: 25°C 77°F

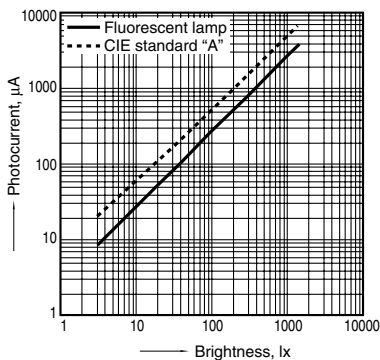

5. Relative photocurrent vs. ambient temperature characteristics

Light source: Fluorescent lamp, Brightness: 100 lx
Reverse voltage: 5V

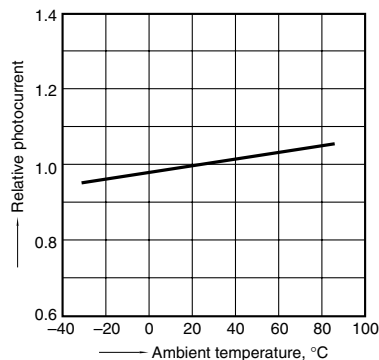

6. Relative photocurrent vs. reverse voltage characteristics

Light source: Fluorescent lamp, Brightness: 100 lx
Ambient temperature: 25°C 77°F

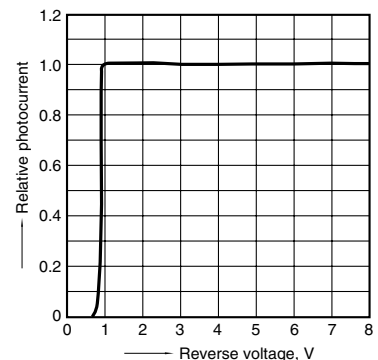

7. Switching time vs. resistive load characteristics

Light source: White LED, Reverse voltage: 2.5V
 Resistive load voltage: 2.5V
 Ambient temperature: 25°C 77°F

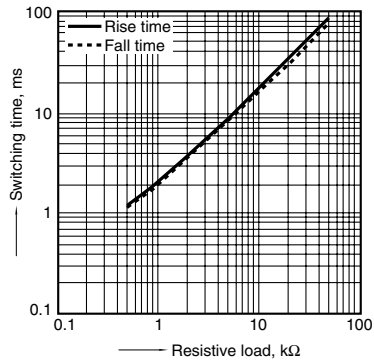

DIMENSIONS

mm inch

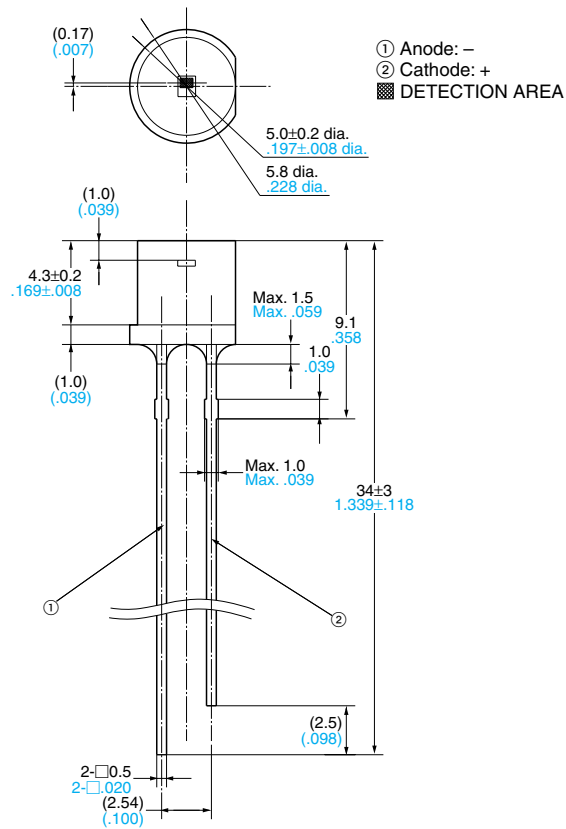
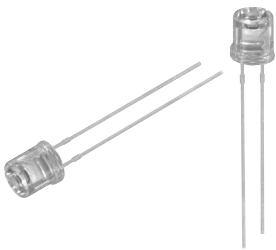

General Tolerance: ±0.5 ±.020

Light Sensor (AMS3)

SAFETY PRECAUTIONS

Be sure to obey the following in order to prevent injuries and accidents.

- Do not use the sensors under conditions that exceed the range of its specifications.
It may cause overheating, smoke, or fire.
- Connect terminals correctly by verifying the pin layout with the specifications diagram or other instructions.
Erroneous connections may lead to unexpected operating errors, overheating, smoke, or fire.
- For an important and serious application in terms of safety, add protection circuit or any other protection method.

CAUTIONS FOR USE

1. Applying stress that exceeds the absolute maximum rating

If the voltage or current value for any of the terminals exceeds the absolute maximum rating, internal elements will deteriorate because of the excessive voltage or current.

In extreme cases, wiring may melt, or silicon P/N junctions may be destroyed. As a result, the design should ensure that the absolute maximum ratings will never be exceeded, even momentarily.

2. Deterioration and destruction caused by discharge of static electricity

This phenomenon is generally called static electricity destruction.

Static electricity generated by various factors flows through the terminal and occurs to destroy internal elements.

To prevent problems from static electricity, the following precautions and measures should be taken when using your device.

- 1) Employees handling sensor should wear anti-static clothing and should be grounded through protective resistance of 500 k Ω to 1 M Ω .
- 2) A conductive metal sheet should be placed over the work table. Measuring instruments and jigs should be grounded.
- 3) When using soldering irons, either use irons with low leakage current, or ground the tip of the soldering iron.
(Use of low-voltage soldering irons is also recommended.)
- 4) Devices and equipment used in assembly should also be grounded.
- 5) When packing printed circuit boards and equipment, avoid using high-polymer materials such as foam styrene, plastic, and other materials which carry an electrostatic charge.
- 6) When storing or transporting sensor, the environment should not be generated static electricity (for instance, the humidity should be between 45 and 60%), and sensor should be protected using conductive packing materials.

3. Just after supplying voltage, please note that current in the sensor will be not constant until internal circuit stability.

4. Storage

The sensors are transparent plastic packages. They are sensitive to moisture and come in moisture-proof packages.

Observe the following cautions when storing.

- 1) After the moisture-proof package is unsealed, take the sensors out of storage as soon as possible (within 1 week at the most).
- 2) If the devices are to be left in storage for a considerable period after the moisture-proof package has been unsealed, it is recommended to keep them in another moisture-proof bag containing silica gel (within 3 months at the most).
- 3) Storage under extreme conditions will cause soldering degradation, external appearance defects, and deterioration of the characteristics.

The following storage conditions are recommended:

- Temperature: 0 to 30°C **32 to 86°F**
 - Humidity: Less than 60% R.H. (Avoid freezing and condensing)
 - Atmosphere: No harmful gasses such as sulfurous acid gas, minimal dust.
- * When mounting with solder, if thermal stress is applied to sensors that have absorbed moisture, the moisture will vaporize, swelling will occur, and the inside of the package will become stressed.

This may cause the package surface to blister or crack. Therefore, please take caution and observe the soldering conditions in the following section.

5. Recommended soldering conditions

- 1) Recommended condition
(1) Double wave soldering method

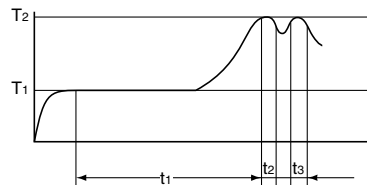

- T₁ = 120°C **248°F**
- T₂ = 260°C **500°F** or less
- t₁ = 120 s or less
- t₂+t₃ = 6 s or less

- (2) Soldering iron method

Tip temperature: 350 to 400°C **662 to 752°F**

Wattage: 30 to 60 W

Soldering time: within 3 s

- 2) The soldered position on leads should not be closer than 3mm **.118inch** to the molding resin of this sensor.

6. Notes for mounting

- 1) Temperature rise in the lead portion is highly dependent on package size. If multiple different packages are mounted on the same board, please check your board beforehand in an actual product, ensuring that the temperature of the solder area of the sensor terminals falls within the temperature conditions of item 5.

- 2) If the mounting conditions exceed the recommended solder conditions in item 5, resin strength will fall and the mismatching of the heat expansion coefficient of each constituent material will increase markedly, possibly causing cracks in the package, disconnections of bonding wires, and the like. For this reason, please inquire with us about whether this use is possible.

7. Cleaning solvents compatibility

We recommend dip cleaning with an organic solvent for removal of solder flux etc.

If you cannot avoid using ultrasonic cleansing, please ensure that the following conditions are met, and check beforehand for defects.

- Frequency: 27 to 29 kHz
- Ultrasonic power:
No greater than 0.25W/cm²
- Cleaning time:
No longer than 30 s
- Cleanser used: Asahiklin AK-225
- Other: Submerge in solvent in order to prevent the PCB and sensors from being contacted directly by the ultrasonic vibrations.

Note: Applies to unit area ultrasonic power for ultrasonic baths.

8. Transportation

Extreme vibration during transport will warp the lead or damage the sensor. Handle the outer and inner boxes with care.

9. Avoid using the sensor in environments containing excessive amounts of steam, dust, corrosive gas, or where organic solvents are present.

10. Lead forming and cutting

- 1) Lead forming must be done at normal temperature before soldering
- 2) The bent and cut position on leads should not be closer than 3mm .118inch to the base of leads.
- 3) Lead forming and cutting must be done while fixing the base of leads.
- 4) Avoid mounting with stress at the base of leads.

11. The following shows the packaging format

mm inch

		Tape dimensions		
		Symbol	Dimensions	Remarks
Light sensor NaPiCa Through-hole type		P ₀	12.7±0.3 .500±.012	
		P	12.7±1.0 .500±.039	
		P ₂	6.35±1.3 .250±.051	
		H	20.5±1.0 .807±.039	
		F	2.54±0.5 .100±.020	
		Δh	0±1.0 0±.039	
		Δp	0±1.0 0±.039	
		W	18.0 ^{+1.0} _{-0.5} .709 ^{+0.033} _{-.020}	
		W ₀	13.0±0.3 .512±.012	
		W ₁	9.0 ^{+0.75} _{-0.5} .354 ^{+0.030} _{-.020}	
		W ₂	0 to 0.5 0 to .020	
		D ₀	3.8±0.2 .150±.008	
		t	0.5±0.2 .020±.008	

Zigzag tape style is used.

Light Sensor NaPiCa terminology

Term	Symbol	Explanation
Reverse voltage	V _R	The applied voltage between the cathode and anode.
Photocurrent	I _L	The current that flows between the cathode and anode when light is applied.
Power dissipation	P	The electric power loss that occurs between the cathode and anode.
Operating temperature	T _{opr}	The workable ambient temperature range at which normal operation is possible under the condition of a prescribed allowable loss.
Storage temperature	T _{stg}	The ambient temperature range at which the sensor can be left or stored without applying voltage.
Peak sensitivity wavelength	λ _p	The wavelength of light at which sensitivity is at its maximum.
Dark current	I _D	The current between the cathode and anode when reverse voltage is applied during darkness.
Rise time	t _r	Time required for the output waveform to rise from 10% to 90% when light is applied.
Fall time	t _f	Time required for the output waveform to fall from 90% to 10% when light is cut.