

## 阅读申明

- 1.本站收集的数据手册和产品资料都来自互联网，版权归原作者所有。如读者和版权方有任何异议请及时告之，我们将妥善解决。
- 2.本站提供的中文数据手册是英文数据手册的中文翻译，其目的是协助用户阅读，该译文无法自动跟随原稿更新，同时也可能存在翻译上的不当。建议读者以英文原稿为参考以便获得更精准的信息。
- 3.本站提供的产品资料，来自厂商的技术支持或者使用者的心得体会等，其内容可能存在描述上的差异，建议读者做出适当判断。
- 4.如需与我们联系，请发邮件到marketing@iczoom.com，主题请标有“数据手册”字样。

## Read Statement

1. The datasheets and other product information on the site are all from network reference or other public materials, and the copyright belongs to the original author and original published source. If readers and copyright owners have any objections, please contact us and we will deal with it in a timely manner.
2. The Chinese datasheets provided on the website is a Chinese translation of the English datasheets. Its purpose is for reader's learning exchange only and do not involve commercial purposes. The translation cannot be automatically updated with the original manuscript, and there may also be improper translations. Readers are advised to use the English manuscript as a reference for more accurate information.
3. All product information provided on the website refer to solutions from manufacturers' technical support or users the contents may have differences in description, and readers are advised to take the original article as the standard.
4. If you have any questions, please contact us at marketing@iczoom.com and mark the subject with "Datasheets" .

### Omron's Next Generation of Sub-miniature Photoelectric Sensors

- Utilizes Omron's "Hyper LED" technology to achieve the industry's smallest visible red beam
- Self-contained sensor ideal for space-restricted applications
- "Pin-point" beam for detecting extremely small objects
- Offered in both flat and rectangular body styles
- Retroreflective model employs Omron's Free-Angle Optics technology (FAO) to detect objects as small as 2 mm dia.
- Convergent-beam model spot diameter is 0.15 mm
- Through-beam model is capable of sensing distances of 1 meter with a 2 mm target diameter
- CE conformance
- Robotic cable versions available (See Note 2, below.)



## Ordering Information

### ■ PHOTOELECTRIC SENSORS

| Sensor type      |          | Sensing method |                 |                 |                    |                  |                 |                 |
|------------------|----------|----------------|-----------------|-----------------|--------------------|------------------|-----------------|-----------------|
|                  |          | Through-beam   |                 | Retroreflective | Diffuse reflective | Convergent-beam  |                 |                 |
| Appearance       |          | Side-view      | Flat            | Side-view       | Flat               | Side-view        |                 |                 |
|                  |          |                |                 |                 |                    |                  |                 |                 |
| Sensing distance |          | 1 m            | 500 mm          | 10 to 200 mm    | 5 to 30 mm         | 5 to 15 mm       | 5 to 30 mm      |                 |
| Part number      | Light-ON | NPN            | <b>E3T-ST11</b> | <b>E3T-FT11</b> | <b>E3T-SR11</b>    | <b>E3T-FD11N</b> | <b>E3T-SL11</b> | <b>E3T-SL21</b> |
|                  |          | PNP            | <b>E3T-ST13</b> | <b>E3T-FT13</b> | <b>E3T-SR13</b>    | <b>E3T-FD13N</b> | <b>E3T-SL13</b> | <b>E3T-SL23</b> |
|                  | Dark-ON  | NPN            | <b>E3T-ST12</b> | <b>E3T-FT12</b> | <b>E3T-SR12</b>    | <b>E3T-FD12N</b> | <b>E3T-SL12</b> | <b>E3T-SL22</b> |
|                  |          | PNP            | <b>E3T-ST14</b> | <b>E3T-FT14</b> | <b>E3T-SR14</b>    | <b>E3T-FD14N</b> | <b>E3T-SL14</b> | <b>E3T-SL24</b> |

Note: 1. All through-beam models are packaged and sold as pairs (one transmitter and one receiver).

2. E3T sensors are available with robotic cable. To order, add the letter "R" to the end of the part number. Example: E3T-ST11R

3. 5-M cable models are available. To order, add the designation 5M to the end of the part number. Example: E3T-T11 5M

## ■ ACCESSORIES (ORDER SEPARATELY)

### Slits (Apertures)

| Slits for sensor models | Slit width | Sensing distance | Minimum sensing object (typical) | Comments                          | Part number |
|-------------------------|------------|------------------|----------------------------------|-----------------------------------|-------------|
| E3T-ST1□                | 0.5 dia.   | 50 mm            | 0.5 mm wide                      | One each for Emitter and Receiver | E39-S63     |
|                         | 1 dia.     | 100 mm           | 1 mm wide                        |                                   |             |

| Slits for sensor models | Slit width | Sensing distance | Minimum sensing object (typical) | Comments                          | Part number |
|-------------------------|------------|------------------|----------------------------------|-----------------------------------|-------------|
| E3T-FT1□                | 0.5 dia.   | 50 mm            | 0.5 mm wide                      | One each for Emitter and Receiver | E39-S64     |
|                         | 1 dia.     | 100 mm           | 1 mm wide                        |                                   |             |

### Reflectors





| Item                          | Sensing distance | Minimum sensing object (typical) | Part number           |
|-------------------------------|------------------|----------------------------------|-----------------------|
| Compact retroreflective model | 10 to 200 mm     | 2 mm wide                        | E39-R4<br>(See Note.) |
|                               | 10 to 100 mm     |                                  | E39-R37               |

Note: E39-R4 reflector included with the E3T-SR1□ (can also be ordered separately).

### Adjustable Aperture

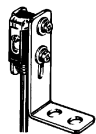
| For sensor models | Appearance  | Part number |
|-------------------|---|-------------|
| E3T-ST1□          |  | E39-E10     |

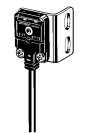
### Mounting Brackets

| For sensor models | Appearance  | Comments  | Part number |
|-------------------|---|---|-------------|
| E3T-S□            |  | Two mounting brackets are required for through-beam models. | E39-L116    |
|                   |  |   | E39-L117    |
|                   |  |   | E39-L118    |
| E3T-F□            |  | E39-L119  |             |
|                   |  | E39-L120  |             |

# Specifications

## ■ RATINGS/CHARACTERISTICS

| Sensing method                                       |                   | Through-beam  |       |           |       | Retroreflective  |       | Convergent beam                             |       |   |       | Diffuse reflective                          |                   |
|--|-------------------|---|-------|-----------|-------|--|-------|---|-------|---|-------|---|-------------------|
| Shape  |                   | Side-view   |       | Flat      |       | Side-view  |       |   |       |   |       | Flat  |                   |
| Output type  |                   | NPN   | PNP   | NPN       | PNP   | NPN  | PNP   | NPN   | PNP   | NPN   | PNP   | NPN   | PNP               |
| Part number  | Light-ON          | -ST11   | -ST13 | -FT11     | -FT13 | -SR11  | -SR13 | -SL11                                       | -SL13 | -SL21                                       | -SL23 | -FD11                                       | -FD13             |
|  | Dark-ON           | -ST12   | -ST14 | -FT12     | -FT14 | -SR12  | -SR14 | -SL12                                       | -SL14 | -SL22                                       | -SL24 | -FD12                                       | -FD14             |
| Sensing distance                                     |                   | 1 m<br>(adjustable aperture is available)   |       | 500 mm    |       | 10 to 200 mm<br>(with the E39-R4)  |       | 5 to 15 mm<br>(50 x 50 mm Kodak white card) |       | 5 to 30 mm<br>(50 x 50 mm Kodak white card) |       | 5 to 30 mm<br>(50 x 50 mm Kodak white card) |                   |
| Standard sensing target                              |                   | 2 mm dia. min.  |       |           |       | 10 mm dia. min.  |       | ---   |       |   |       |   |                   |
| Min. sensing target (typical)                        |                   | 2 mm dia. min.  |       |           |       | 2 mm dia.<br>(sensing distance at 100 mm)  |       | 0.15 mm dia. (sensing distance at 10 mm)    |       |   |       |   |                   |
| Hysteresis   |                   | ---   |       |           |       |  |       | 2 mm max.                                   |       | 6 mm max.                                   |       | 6 mm max.                                   |                   |
| Optical angle  | Emitter           | 3° to 10°   |       | 3° to 13° |       | 2° to 5°   |       | ---   |       |   |       |   |                   |
|  | Receiver          | 3° to 70°   |       | 3° to 70° |       | ---  |       |   |       |   |       |   |                   |
| Light source (wave length)                           |                   | Red LED ("Pin-point" LED) ( $\lambda=670$ nm)   |       |           |       |  |       |   |       |   |       |   |                   |
| Power supply voltage                                 |                   | 12 to 24 VDC $\pm 10\%$ , ripple (p-p) 10% max.   |       |           |       |  |       |   |       |   |       |   | 24 VDC $\pm 10\%$ |
| Current consumption                                  |                   | 12 mA max. emitter/receiver   |       |           |       | 20 mA max.   |       |   |       |   |       |   |                   |
| Output   |                   | Open collector, load current: 50 mA max. at 24 VDC, residual voltage: 1 V max., operation mode: Light-ON or Dark-ON (separate models) |       |           |       |  |       |   |       |   |       |   |                   |
| Circuit protection (See <i>Precautions</i> Section.) |                   | Protection from reversed and output short-circuit   |       |           |       | Protection from reversed polarity, output short-circuit, and mutual interference |       |   |       |   |       |   |                   |
| Response time  |                   | 1 ms max. each for on and off   |       |           |       |  |       |   |       |   |       |   |                   |
| Ambient light immunity                               | Incandescent lamp | 5,000 lx max.   |       |           |       |  |       |   |       |   |       |   |                   |
|  | Sunlight          | 10,000 lx max.  |       |           |       |  |       |   |       |   |       |   |                   |
| Ambient temperature                                  | Operating         | -25°C to 55°C (-13°F to 131°F)  |       |           |       |  |       |   |       |   |       |   |                   |
|  | Storage           | -40°C to 70°C (-40°F to 158°F) with no icing or condensation  |       |           |       |  |       |   |       |   |       |   |                   |
| Ambient humidity                                     | Operating         | 35% to 85% RH   |       |           |       |  |       |   |       |   |       |   |                   |
|  | Storage           | 35% to 95% RH (with no condensation)  |       |           |       |  |       |   |       |   |       |   |                   |
| Insulation resistance                                |                   | 20 M $\Omega$ min. (at 500 VDC)   |       |           |       |  |       |   |       |   |       |   |                   |
| Dielectric strength                                  |                   | 1,000 VAC, 50/60 Hz for 1 min   |       |           |       |  |       |   |       |   |       |   |                   |
| Vibration resistance                                 |                   | 10 to 2,000 Hz, 1.5-mm double amplitude or 300 m/s <sup>2</sup> (approx. 30G) for 0.5 hrs each in X, Y, and Z axis                    |       |           |       |  |       |   |       |   |       |   |                   |
| Shock resistance                                     |                   | 1,000 m/s <sup>2</sup> (approx. 100G) 3 times each in X, Y, and Z axis  |       |           |       |  |       |   |       |   |       |   |                   |
| Enclosure rating                                     |                   | IEC60529: IP67  |       |           |       |  |       |   |       |   |       |   |                   |
| Connection method                                    |                   | Pre-leaded (standard length: 2 m), optional 5-M cable, optional robotic cable   |       |           |       |  |       |   |       |   |       |   |                   |
| Weight (with packaging)                              |                   | Approx. 40 g  |       |           |       | Approx. 20 g   |       |   |       |   |       |   |                   |
| Materials  | Case              | PBT   |       |           |       |  |       |   |       |   |       |   |                   |
|  | Lens and cover    | Polycarbonate   |       |           |       |  |       |   |       |   |       |   |                   |
| Accessories included                                 |                   | Two each of M2 mounting screws, spring washers, and flat washers, and reflector (E39-R4: retroreflective model only)                  |       |           |       |  |       |   |       |   |       |   |                   |

# Engineering Data

## EXCESS GAIN VS. SET DISTANCE (TYPICAL)

**E3T-ST1** (Through-beam)

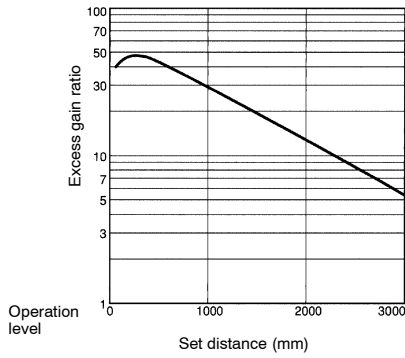

**E3T-FT1** (Through-beam)

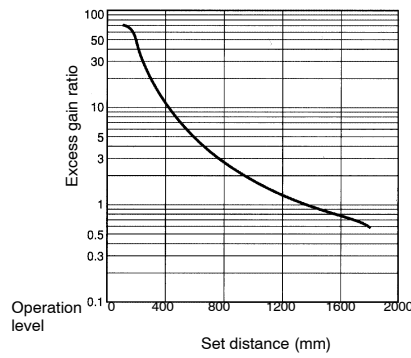

**E3T-SR1** with E39-R4 (Retroreflective)

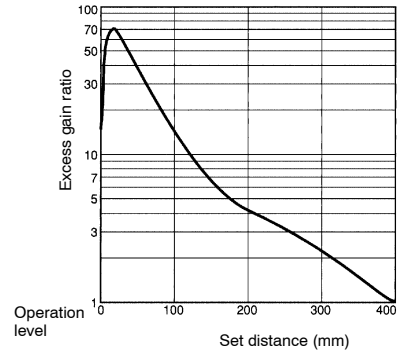

**E3T-FD1** (Diffuse Reflective)

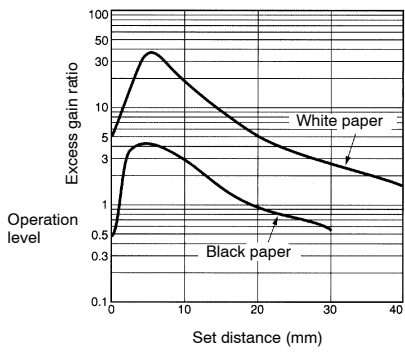

**E3T-SL1** (Convergent Beam)

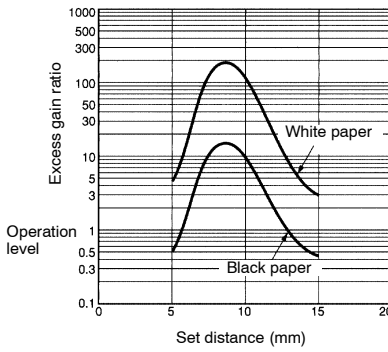

**E3T-SL2** (Convergent Beam)

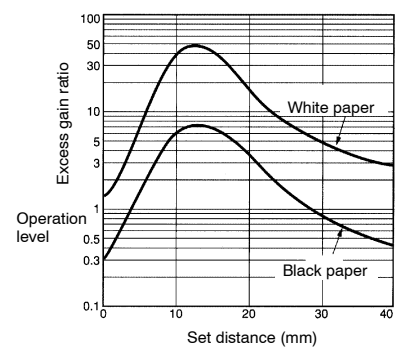

**PARALLEL OPERATING RANGE (TYPICAL)**

**E3T-ST1** □ with Slit (Aperture)  
(Through-Beam)

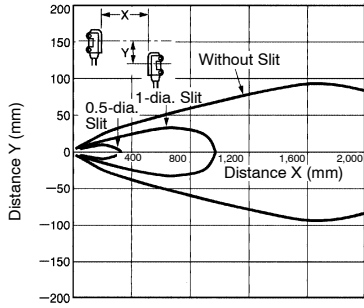

**E3T-ST1** □ with Slit (Enlarged graph)  
(Through-Beam)

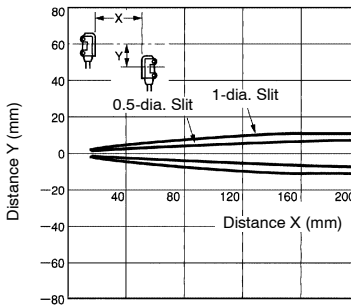

**E3T-SR1** □ with E39-R4  
(Retroreflective)

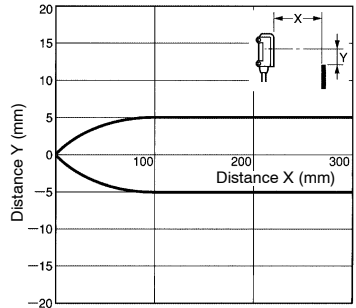

**E3T-FT1** □ with Slit (Through-Beam)

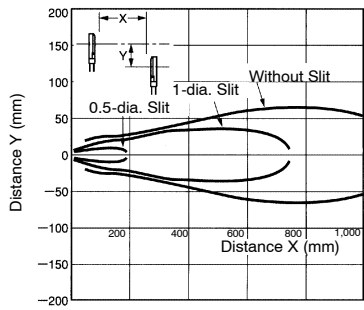

**E3T-FT1** □ with Slit (Enlarged graph)  
(Through-Beam)

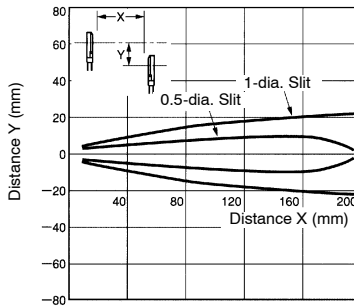

**ANGLE CHARACTERISTICS (TYPICAL)**

**E3T-SL1** □  
(Up and Down)

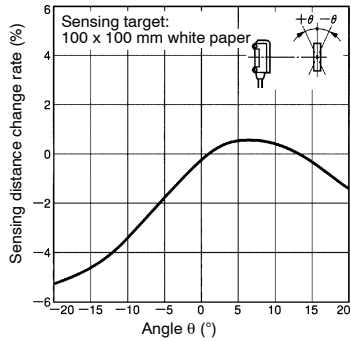

**E3T-SL1** □  
(Left and Right)

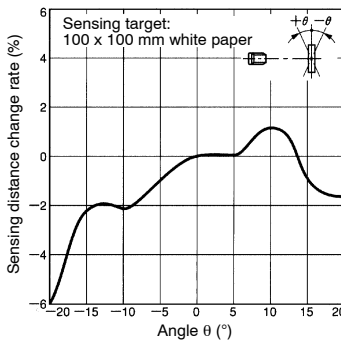

**■ CLOSE-DISTANCE SENSING CAPABILITY (TYPICAL)**

E3T-SL1□, E3T-SL2□, E3T-FD1□

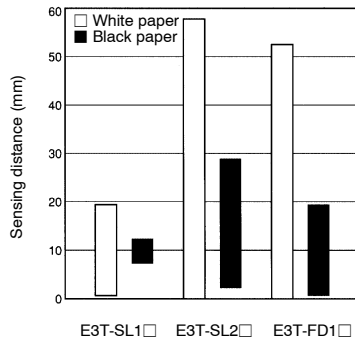

**■ SENSING TARGET SIZE VS. SENSING DISTANCE (TYPICAL)**

E3T-SL1□

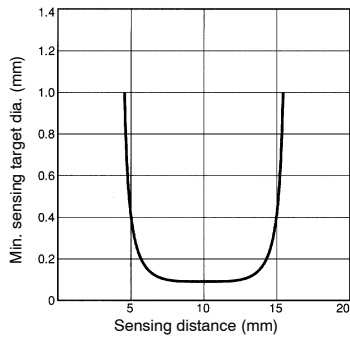

E3T-FD1□, E3T-SL2□

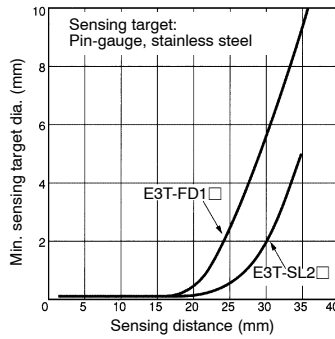

**■ OPERATION RANGE (TYPICAL)**

E3T-FD1□ (Diffuse Reflective)

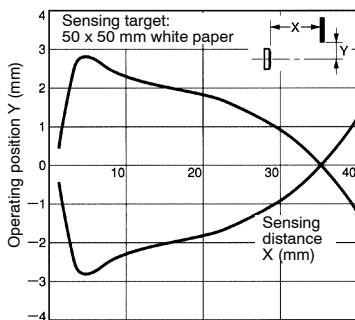

E3T-SL1□ (Convergent Beam)

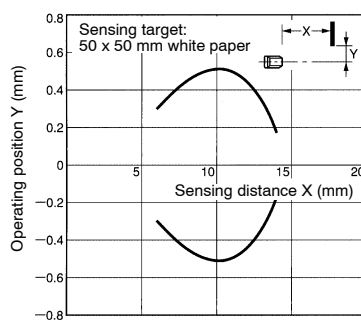

E3T-SL2□ (Convergent Beam)

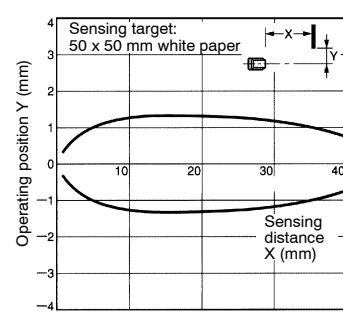

■ SENSING DISTANCE CHARACTERISTICS OF ADJUSTABLE APERTURE (WHEN COMPLETING OPTICAL AXIS ADJUSTMENT)

E3T-SL1□ with E39-E10

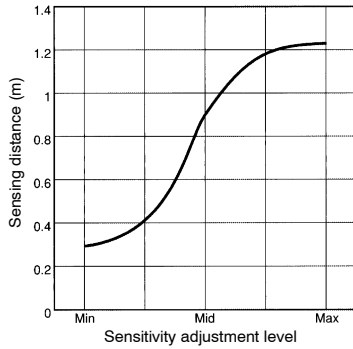

Operation

■ OUTPUT CIRCUITS

|                |          |          |
|----------------|----------|----------|
| NPN models     | E3T-□□□1 | E3T-□□□2 |
| Operation mode | Light-ON | Dark-ON  |
| Output circuit |          |          |

|                  |  |          |
|------------------|--|----------|
| PNP models       | E3T-□□□3   | E3T-□□□4 |
| Operation mode   | Light-ON   | Dark-ON  |
| Output circuit   | <p>Receiver (through-beam models),<br/>Retroreflective, diffuse reflective, and convergent beam models</p> |          |
| Internal circuit | <p>Emitter (through-beam models)</p>   |          |



**■ TIMING CHART**

|                              |                              |                           |                              |                           |
|------------------------------|------------------------------|---------------------------|------------------------------|---------------------------|
| Diffuse and convergent beam  | <b>Light-ON</b>              |                           | <b>Dark-ON</b>               |                           |
|                              | Target present               |                           | Target present               |                           |
|                              | Target not present           |                           | Target not present           |                           |
|                              | Operation indicator (orange) | ON<br>OFF                 | Operation indicator (orange) | ON<br>OFF                 |
|                              | Output transistor            | ON<br>OFF                 | Output transistor            | ON<br>OFF                 |
|                              | Load                         | Energized<br>De-energized | Load                         | Energized<br>De-energized |
| Retroreflective/through-beam | <b>Light-ON</b>              |                           | <b>Dark-ON</b>               |                           |
|                              | Target present               |                           | Target present               |                           |
|                              | Target not present           |                           | Target not present           |                           |
|                              | Operation indicator (orange) | ON<br>OFF                 | Operation indicator (orange) | ON<br>OFF                 |
|                              | Output transistor            | ON<br>OFF                 | Output transistor            | ON<br>OFF                 |
|                              | Load                         | Energized<br>De-energized | Load                         | Energized<br>De-energized |

**Dimensions**

Unit: mm (inch)

**■ SIDE-VIEW SENSORS**

**Through-Beam Models**

- E3T-ST11
- E3T-ST12
- E3T-ST13
- E3T-ST14

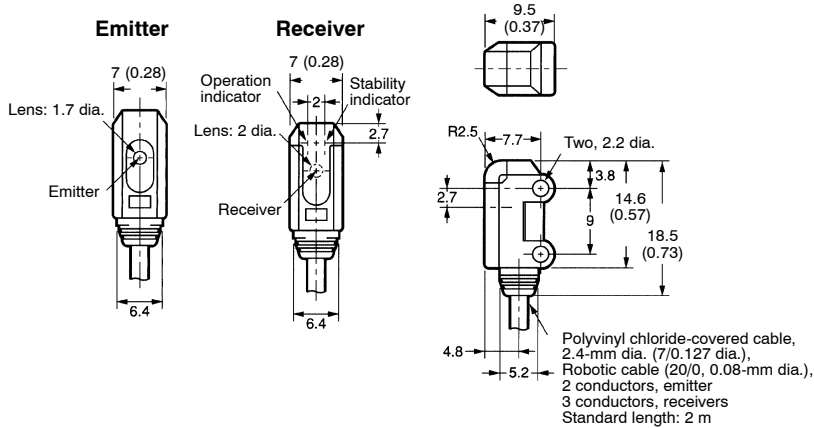
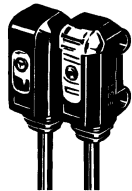

**Mounting Holes**

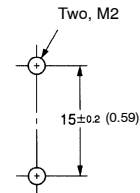

**Retroreflective Models**

- E3T-SR11
- E3T-SR12
- E3T-SR13
- E3T-SR14

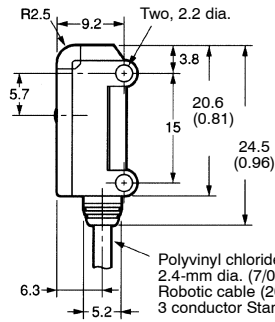
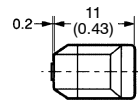
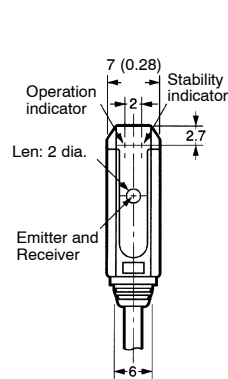

**Mounting Holes**

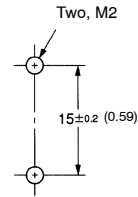

**Convergent-Beam Models**

- E3T-SL11
- E3T-SL12
- E3T-SL13
- E3T-SL14
- E3T-SL21
- E3T-SL22
- E3T-SL23
- E3T-SL24

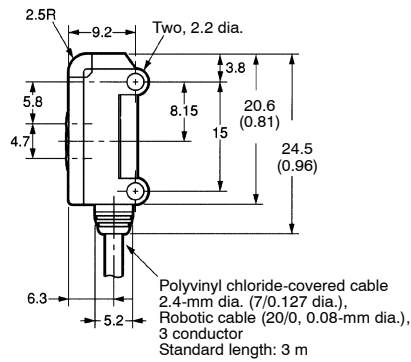
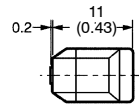
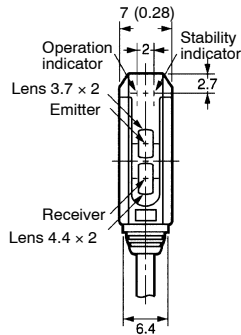

**Mounting Holes**

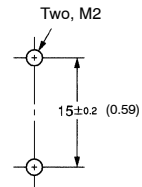

Unit: mm (inch)

■ FLAT THIN SENSORS

Through-Beam Emitter and Receiver Models

- E3T-FT11
- E3T-FT12
- E3T-FT13
- E3T-FT14

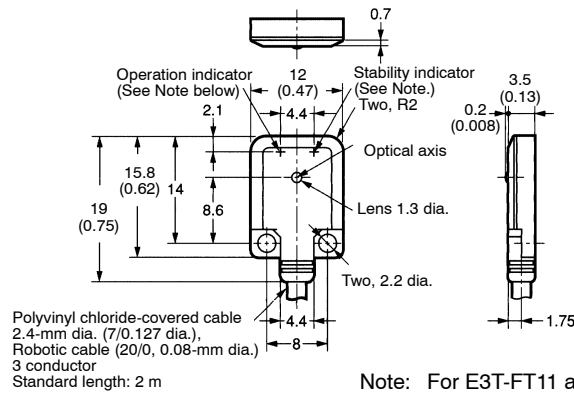
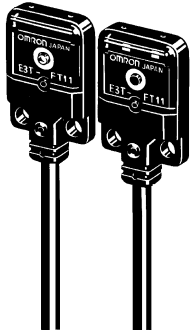

Mounting Holes

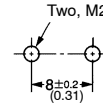

Note: For E3T-FT11 and E3T-FT12 Receivers only.

Diffuse Reflective Models

- E3T-FD11-N
- E3T-FD12-N
- E3T-FD13-N
- E3T-FD14-N

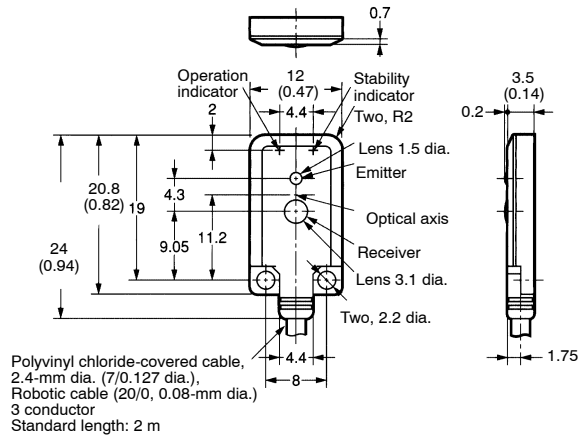
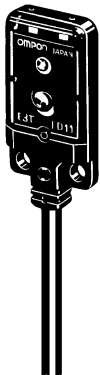

Mounting Holes

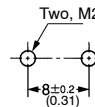

■ REFLECTORS

Retroreflector

E39-R4 (Provided with the E3T-SR1 □)

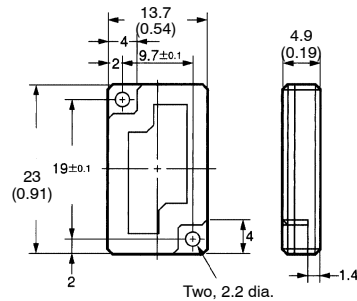
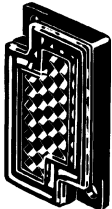

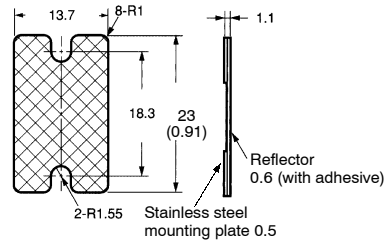
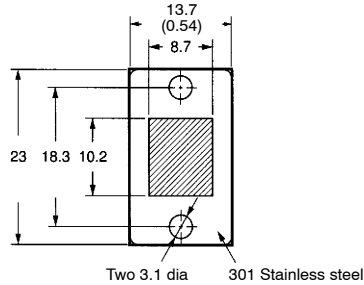
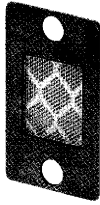
**E39-R37 Reflector**

Note: A reflector and a stainless steel mounting plate are supplied together as a set.

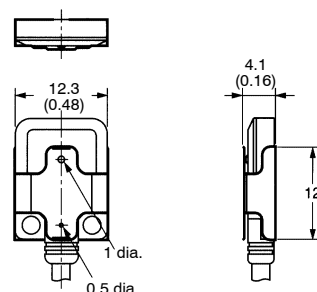
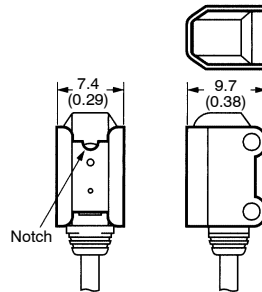
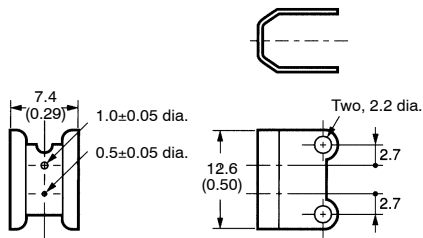
**■ SLITS/APERTURES (ORDER SEPARATELY)****E39-S63 (Use with E3T-ST1□)****Shown with Sensor****E39-S64 (Use with E3T-FT1□)**

Note: Align the notch direction of the slit when installing on the Emitter and Receiver.

**Adjustable Aperture****E39-E10 (Use with E3T-ST1□)**

With the Adjustable Aperture Unit in Place

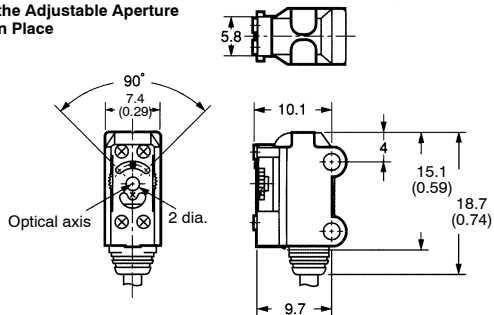
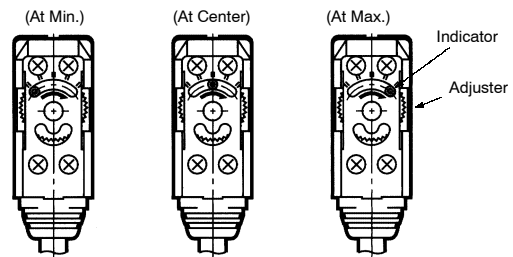
**Use of E39-E10 Adjustable Aperture (Example Dark-ON: E3T-ST12/ST14)**

For Dark-ON:

1. Mount the unit on the receiver.
2. Set the adjuster of the Unit to Max (factory setting is at Max).
3. Adjust the optical axis (align) and tighten mounting hardware.
4. Place a target between emitter and receiver and gradually turn the adjuster counterclockwise toward the Min side. Stop turning the adjuster when the operation indicator and stability indicator (green) turn ON.
5. Remove the target and confirm that the operation indicator is OFF and the stability indicator (green) is ON.

Note: For Light-ON, adjustment is similar, except that indicators would operate in opposite manner as with Dark-ON.

Unit: mm (inch)

**■ MOUNTING BRACKETS**

**E39-L116 (Use with E3T-S□□□) Order Separately**

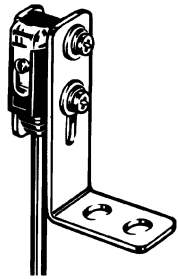

Material: 1.2-mm-thick stainless steel (SS 304)

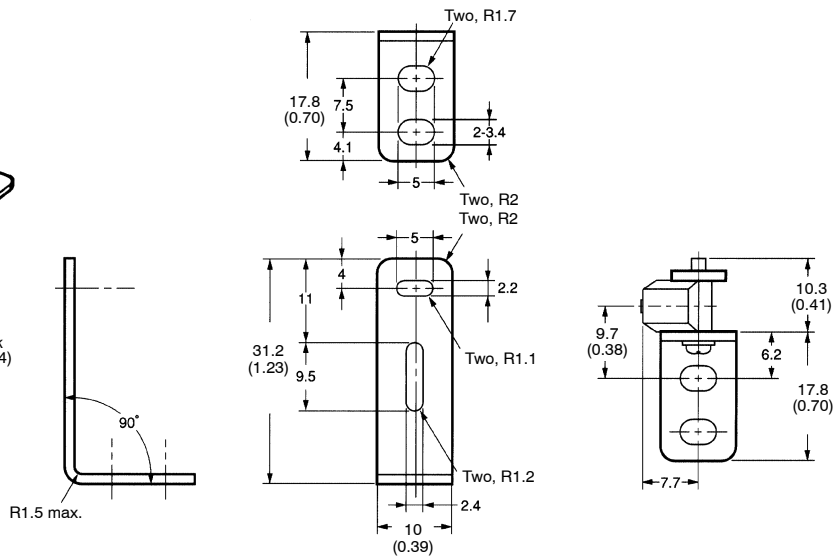

**E39-L116 (Use with E3T-ST1□)**

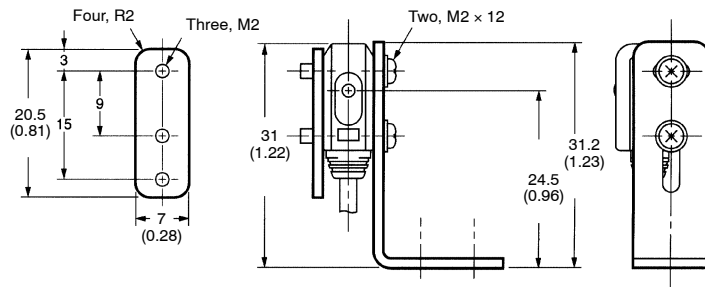

Order brackets separately.

**E39-L117 (Use with E3T-S□□□)**

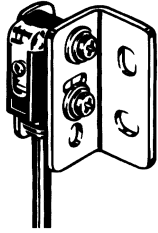

Material: 1.2-mm-thick stainless steel (SS 304)

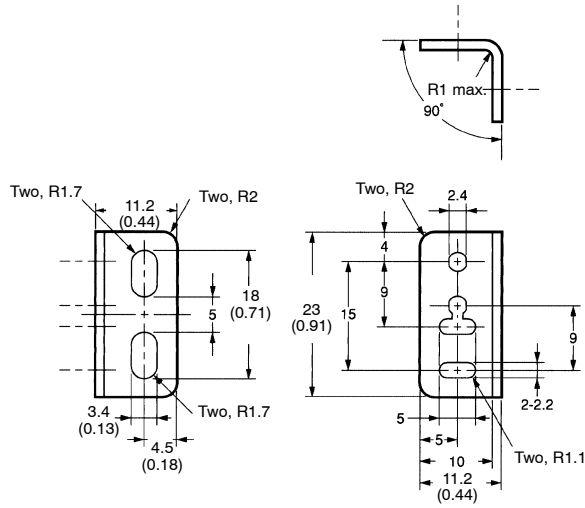

**E39-L117 (Shown with E3T-ST1□)**

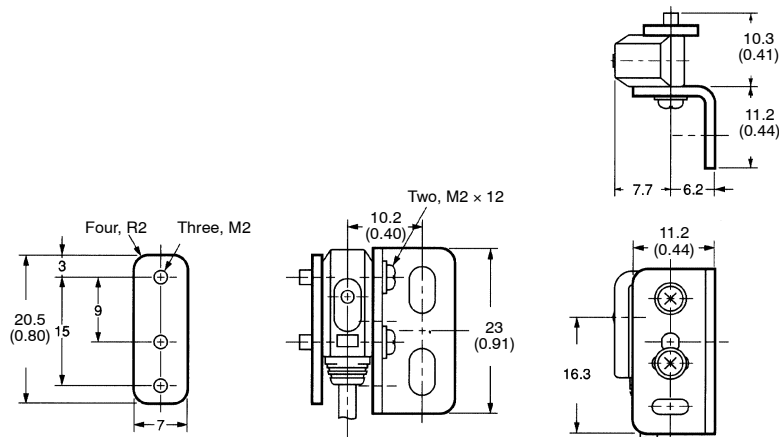

Unit: mm (inch)

Order brackets separately.

**E39-L118 (Use with E3T-S□□□)**

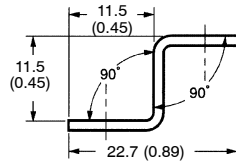
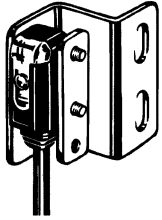

Material: 1.2-mm-thick stainless steel (SS 304)

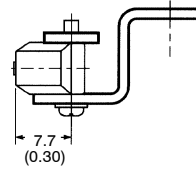
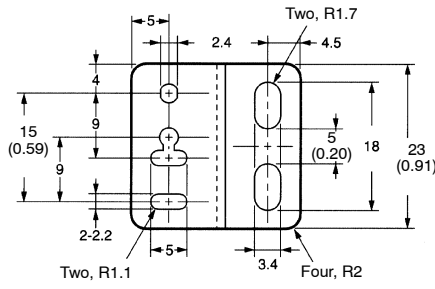

**E39-L118 (Shown with E3T-ST1□)**

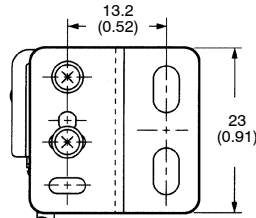
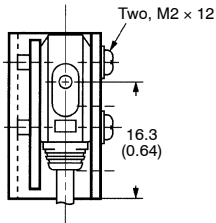
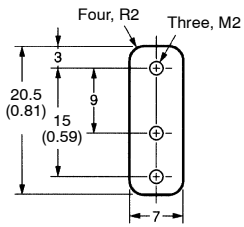

Mounting Brackets for E3T-FT1□/E3T-FD1□

E39-L119

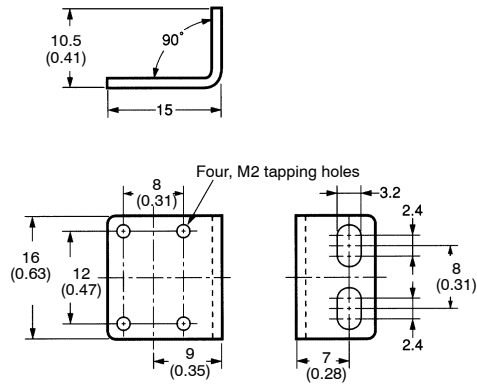
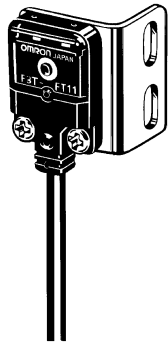

E39-L119 Shown with E3T-F□1□

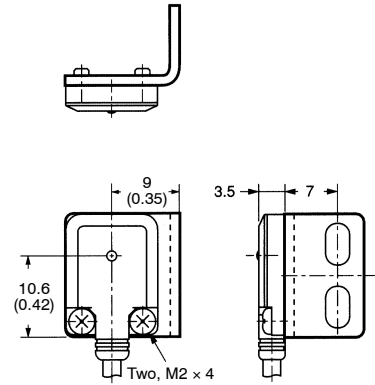

E39-L120

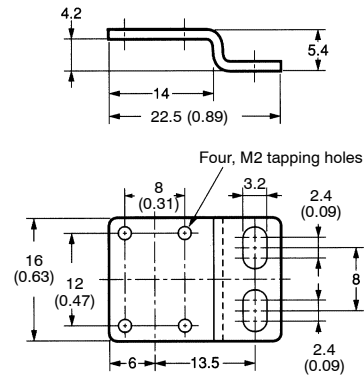
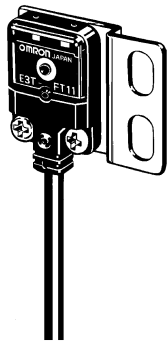

E39-L120 (Shown with E3T-F□1□)

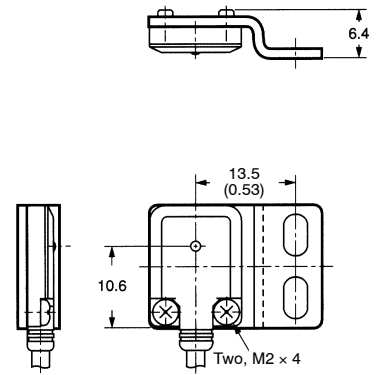



## Precautions



### Caution

Avoid damage to the E3T: NEVER apply AC power to the E3T.

### ■ AVOID DAMAGE TO THE E3T

- Do not exceed the rated voltage on the E3T.
- Do not short-circuit the load connected to the E3T.
- When supplying power to the E3T, make sure that the polarity of the power is correct.

### ■ OPERATING ENVIRONMENT

To avoid malfunction, DO NOT install the E3T in the following environments:

- Locations where the E3T is exposed to intense sunlight.
- Locations with high humidity and where condensation may result.
- Locations with corrosive gas.
- Locations with vibration or shock affecting the E3T.

### ■ HIGH-TENSION LINES

To avoid Sensor damage or malfunctioning due to induction noise, do not place the power supply lines of the Photoelectric Sensor within the same conduit as power lines or high-tension lines.

### ■ CABLE

The cable can be extended up to 100 m provided that cable thickness does not exceed the 0.3 mm<sup>2</sup> maximum.

### ■ POWER SUPPLIES

If a switching regulator is connected to the E3T, you must ground the FG (frame ground) and G (ground) terminals, or the switching noise of the switching regulator may cause the E3T to malfunction.

### ■ WATER RESISTANCE

- Do not use the E3T underwater, outdoors, or in the rain.
- Use M2 screws and washers to mount the E3T. When mounting the E3T, NEVER strike the E3T with a hammer, or the E3T will lose its watertight properties.

### ■ LOAD SHORT-CIRCUIT PROTECTION

The E3T incorporates a load short-circuit protection function. If the load short-circuits, the output of the E3T will be turned OFF. Recheck the wiring and turn on the E3T again to reset the load short-circuit protection function. The load short-circuit protection function will work if there is a current flow that is 2.4 times larger than the rated load current.

When using an inductance load, be sure that the inrush current will not exceed 2.4 times larger than the rated current.

### ■ CLEANING

DO NOT apply paint thinner when cleaning the E3T. Paint thinner will damage the casing of the E3T.

### ■ INDICATORS

The following graphs indicate the status of each operation level.

Be sure to use the E3T within the stable operating range.

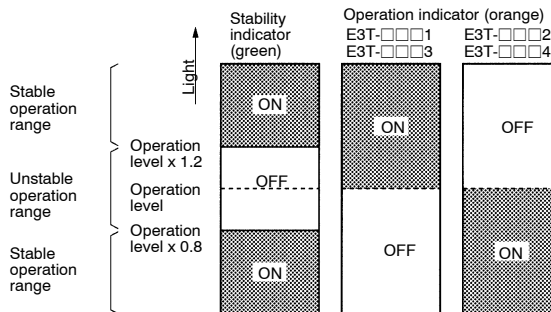

Note: When the E3T's operation level is set to the stable operation range, the E3T will be in its most reliable operation without being influenced by temperature, voltage fluctuation, dust, or mounting changes.

### ■ TURNING ON POWER SUPPLY

- The E3T will be ready for sensing 100 ms after the power is turned ON.
- If the E3T is connected to a power source different from one for loads, be sure to turn ON the power supply to the E3T first.

**NOTE: DIMENSIONS SHOWN ARE IN MILLIMETERS. To convert millimeters to inches divide by 25.4.**

# OMRON®

OMRON ELECTRONICS LLC

One East Commerce Drive  
Schaumburg, IL 60173

1-800-55-OMRON

OMRON ON-LINE

Global - <http://www.omron.com>

USA - <http://www.omron.com/oei>

Canada - <http://www.omron.com/oci>

OMRON CANADA, INC.

885 Milner Avenue  
Scarborough, Ontario M1B 5V8

416-286-6465