

## 阅读申明

- 1.本站收集的数据手册和产品资料都来自互联网，版权归原作者所有。如读者和版权方有任何异议请及时告之，我们将妥善解决。
- 2.本站提供的中文数据手册是英文数据手册的中文翻译，其目的是协助用户阅读，该译文无法自动跟随原稿更新，同时也可能存在翻译上的不当。建议读者以英文原稿为参考以便获得更精准的信息。
- 3.本站提供的产品资料，来自厂商的技术支持或者使用者的心得体会等，其内容可能存在描述上的差异，建议读者做出适当判断。
- 4.如需与我们联系，请发邮件到marketing@iczoom.com，主题请标有“数据手册”字样。

## Read Statement

1. The datasheets and other product information on the site are all from network reference or other public materials, and the copyright belongs to the original author and original published source. If readers and copyright owners have any objections, please contact us and we will deal with it in a timely manner.
2. The Chinese datasheets provided on the website is a Chinese translation of the English datasheets. Its purpose is for reader's learning exchange only and do not involve commercial purposes. The translation cannot be automatically updated with the original manuscript, and there may also be improper translations. Readers are advised to use the English manuscript as a reference for more accurate information.
3. All product information provided on the website refer to solutions from manufacturers' technical support or users the contents may have differences in description, and readers are advised to take the original article as the standard.
4. If you have any questions, please contact us at marketing@iczoom.com and mark the subject with "Datasheets" .

# CY SERIES

## Cylindrical Photoelectric Sensor

**Amplifier Built-in**

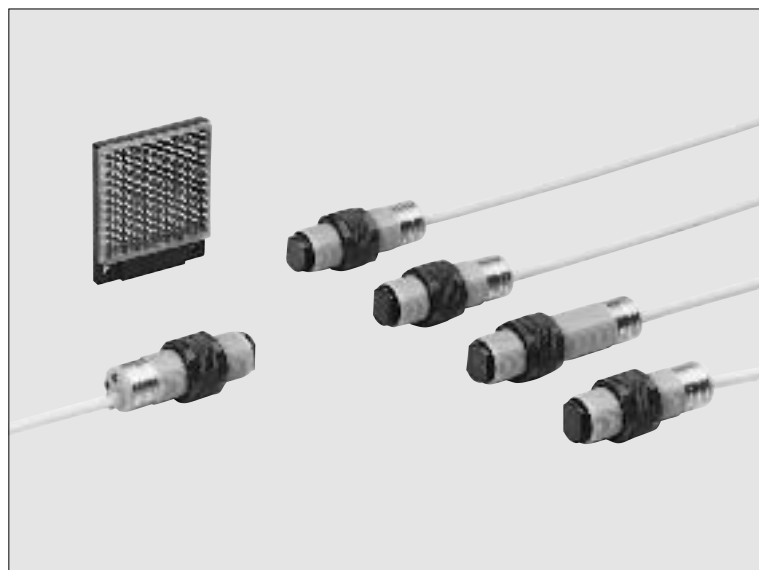

**Cylindrical type easily mountable with M18 thread**



### M18 thread

This sensor has an M18 thread size for convenient mounting.

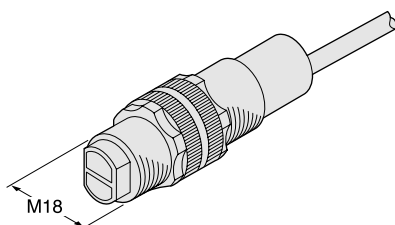

### Easy to replace

A pigtailed type sensor with connector (CY-□-J), which is easy to replace, is also available.

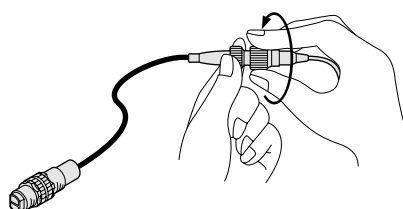

### Long sensing range

#### Thru-beam type

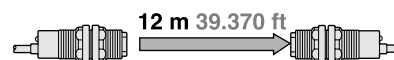

#### Retroreflective type

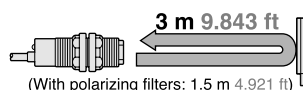

#### Diffuse reflective type

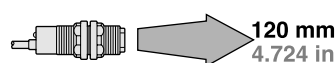

### Wide product range

#### Supply voltage

- ① AC supply type (24 to 240 V AC)
- ② DC supply type (10 to 30 V DC)

#### Output

- ① NPN open-collector transistor
- ② PNP open-collector transistor
- ③ AC non-contact (thyristor) output

#### Connection

- ① Cable type
- ② Pigtailed type

A total of 32 models are available.

### Environment resistant

Its IP67 construction can be hosed down with water. In addition, it has strong resistance against vibration since it is filled up with resin.

The connector also has IP67 protection.



Note: However, take care that if it is exposed to water splashes during operation, it may detect a water drop itself.

### Convenient options

#### Side-view attachment (For thru-beam type sensors only)

The beam is bent at a right angle with the side-view attachment.



#### Slit mask (For thru-beam type sensors only)

It is convenient for detecting small objects or enhancing the sensing accuracy.



## APPLICATIONS

### Sensing cardboard boxes

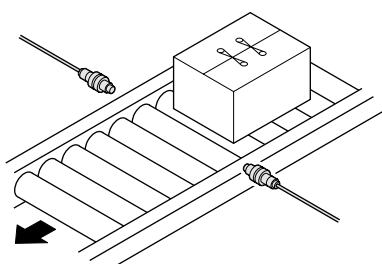

### Sensing specular objects

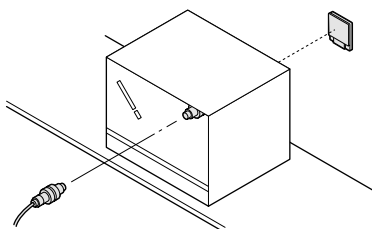

### Sensing milk packs

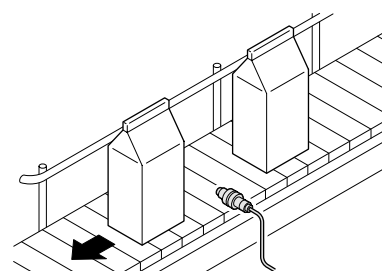

## ORDER GUIDE

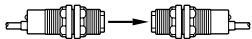
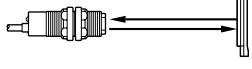
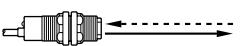
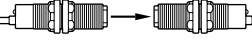
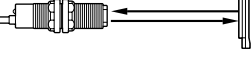
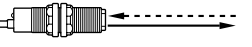
Type	Appearance	Sensing range	Model No.	Supply voltage	Output	Output operation		
DC supply type	Thru-beam		CY-21	10 to 30 V DC	NPN open-collector transistor	Selectable either Light-ON or Dark-ON by the control input		
			CY-21-PN				PNP open-collector transistor	
	Retroreflective With polarizing filters		3 m 9.843 ft (Note)				CY-27	NPN open-collector transistor
							CY-27-PN	PNP open-collector transistor
			1.5 m 4.921 ft (Note)				CY-29	NPN open-collector transistor
							CY-29-PN	PNP open-collector transistor
Diffuse reflective		120 mm 4.724 in	CY-22	NPN open-collector transistor				
			CY-22-PN	PNP open-collector transistor				
AC supply type	Thru-beam		CY-11A	24 to 240 V AC ± 10 %	AC non-contact (thyristor) output	Light-ON		
			CY-11B			Dark-ON		
	Retroreflective With polarizing filters		3 m 9.843 ft (Note)			CY-17A	Light-ON	
						CY-17B	Dark-ON	
			1.5 m 4.921 ft (Note)			CY-19A	Light-ON	
						CY-19B	Dark-ON	
	Diffuse reflective		120 mm 4.724 in			CY-12A	Light-ON	
						CY-12B	Dark-ON	

**NOTE: Reflector is not supplied with the retroreflective type sensor. Please select the suitable reflector or reflective tape from the options.**

Note: The sensing range of the retroreflective type sensor is specified for the RF-230 reflector (optional).

## ORDER GUIDE

### Pigtailed type

Pigtailed type is also available.

#### • Table of Model Nos.

Type		Standard	Pigtailed type (Note)	
DC supply type	NPN output	Thru-beam	<b>CY-21</b>	<b>CY-21-J</b>
		Retroreflective	<b>CY-27</b>	<b>CY-27-J</b>
		With polarizing filters	<b>CY-29</b>	<b>CY-29-J</b>
	Diffuse reflective	<b>CY-22</b>	<b>CY-22-J</b>	
	PNP output	Thru-beam	<b>CY-21-PN</b>	<b>CY-21-PN-J</b>
		Retroreflective	<b>CY-27-PN</b>	<b>CY-27-PN-J</b>
With polarizing filters		<b>CY-29-PN</b>	<b>CY-29-PN-J</b>	
Diffuse reflective	<b>CY-22-PN</b>	<b>CY-22-PN-J</b>		
AC supply type	Light-ON	Thru-beam	<b>CY-11A</b>	<b>CY-11A-J</b>
		Retroreflective	<b>CY-17A</b>	<b>CY-17A-J</b>
		With polarizing filters	<b>CY-19A</b>	<b>CY-19A-J</b>
		Diffuse reflective	<b>CY-12A</b>	<b>CY-12A-J</b>
	Dark-ON	Thru-beam	<b>CY-11B</b>	<b>CY-11B-J</b>
		Retroreflective	<b>CY-17B</b>	<b>CY-17B-J</b>
		With polarizing filters	<b>CY-19B</b>	<b>CY-19B-J</b>
		Diffuse reflective	<b>CY-12B</b>	<b>CY-12B-J</b>

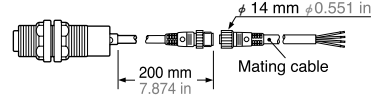

Note: Please order the suitable mating cable separately.

#### • Mating cable

Type	Model No.	Description	
For DC supply type (Note 1)	<b>CN-22-C2</b>	Length: 2 m 6.562 ft	• For the emitter of the thru-beam type sensor (2-core) (Note 2)
	<b>CN-22-C5</b>	Length: 5 m 16.404 ft	
	<b>CN-24-C2</b>	Length: 2 m 6.562 ft	• For the receiver of the thru-beam type sensor, retroreflective type and diffuse reflective type sensors (4-core) (Note 2)
	<b>CN-24-C5</b>	Length: 5 m 16.404 ft	
For AC supply type (Note 1)	<b>CN-32-C2</b>	Length: 2 m 6.562 ft	• For the emitter of the thru-beam type sensor (2-core)
	<b>CN-32-C5</b>	Length: 5 m 16.404 ft	
	<b>CN-33-C2</b>	Length: 2 m 6.562 ft	• For the receiver of the thru-beam type sensor, retroreflective type and diffuse reflective type sensors (3-core)
	<b>CN-33-C5</b>	Length: 5 m 16.404 ft	

Notes: 1) The DC supply type mating cable and the AC supply type mating cable have different connector structure and so are not interchangeable.

2) To use the test input (emission half input) use the 4-core **CN-24-C**.

## OPTIONS

Designation	Model No.	Description		
Slit mask (For thru-beam type sensor only)	OS-CYS	Slit size 11.6 × 0.5 mm 0.457 × 0.020 in	Slit on emitter • Sensing range: 3 m 9.843 ft • Min. sensing object: $\phi$ 8 mm $\phi$ 0.315 in	
		Slit size 11.6 × 1.5 mm 0.457 × 0.059 in	Slit on receiver • Sensing range: 2.5 m 8.202 ft • Min. sensing object: $\phi$ 8 mm $\phi$ 0.315 in	
			Slit on both sides • Sensing range: 0.8 m 2.625 ft • Min. sensing object: 10 × 0.7 mm 0.394 × 0.028 in	
			Slit on emitter • Sensing range: 5 m 16.404 ft • Min. sensing object: $\phi$ 8 mm $\phi$ 0.315 in	
		Slit size 11.6 × 3 mm 0.457 × 0.118 in	Slit on receiver • Sensing range: 4.5 m 14.764 ft • Min. sensing object: $\phi$ 8 mm $\phi$ 0.315 in	
			Slit on both sides • Sensing range: 2 m 6.562 ft • Min. sensing object: 10 × 2 mm 0.394 × 0.079 in	
			Slit on emitter • Sensing range: 7.5 m 24.606 ft • Min. sensing object: $\phi$ 8 mm $\phi$ 0.315 in	
		Slit on receiver • Sensing range: 7 m 22.966 ft • Min. sensing object: $\phi$ 8 mm $\phi$ 0.315 in	Slit on both sides • Sensing range: 4.5 m 14.764 ft • Min. sensing object: 10 × 3 mm 0.394 × 0.118 in	
				Side-view attachment (For thru-beam type sensor only)
Reflector (For retroreflective type sensor only)	RF-230			• Sensing range: 3 m 9.843 ft [CY-27□ & CY-17□], 1.5 m 4.921 ft [CY-29□ & CY-19□]
	RF-220	• Sensing range: 2 m 6.562 ft [CY-27□ & CY-17□], 1.2 m 3.937 ft [CY-29□ & CY-19□]		
	RF-210	• Sensing range: 1 m 3.281 ft [CY-27□ & CY-17□], 0.7 m 2.297 ft [CY-29□ & CY-19□]		
Reflector mounting bracket	MS-RF21-1	Protective mounting bracket for RF-210 It protects the reflector from damage and maintains alignment.		
	MS-RF22	For RF-220		
	MS-RF23	For RF-230		
Reflective tape (For retroreflective type sensor only)	RF-12	• Sensing range: 0.7 m 2.297 ft [CY-27□ & CY-17□], 0.4 m 1.312 ft [CY-29□ & CY-19□]		
	RF-11	• Sensing range: 0.5 m 1.640 ft [CY-27□ & CY-17□]		
Sensor checker (Note)	CHX-SC2	It is useful for beam alignment of thru-beam type sensors. The optimum receiver position is given by indicators, as well as an audio signal.		

Note: Refer to p.414~ for details on the sensor checker CHX-SC2.

### Slit mask • OS-CYS



### Side-view attachment • CY-SV1



### Reflective tape • RF-12

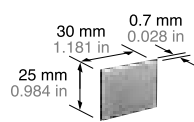

### • RF-11

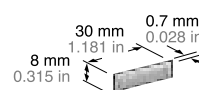

### Reflector • RF-230

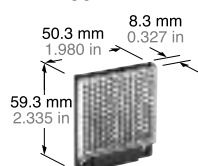

### • RF-220

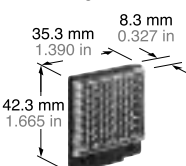

### • RF-210

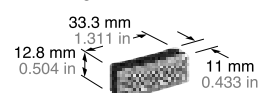

### Reflector mounting bracket

#### • MS-RF23

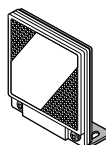

Two M4 (length 10 mm 0.394 in) screws with washers are attached.

#### • MS-RF22

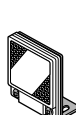

Two M3 (length 8 mm 0.315 in) screws with washers are attached.

#### • MS-RF21-1

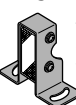

Two M3 (length 12 mm 0.472 in) screws with washers are attached.

### Sensor checker

#### • CHX-SC2

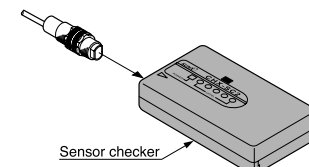

## SPECIFICATIONS

### DC supply type

Item	Model No.	Type	Retroreflective			Diffuse reflective
			Thru-beam		With polarizing filters	
			NPN output type	<b>CY-21</b>	<b>CY-27</b>	<b>CY-29</b>
PNP output type	<b>CY-21-PN</b>	<b>CY-27-PN</b>	<b>CY-29-PN</b>	<b>CY-22-PN</b>		
Sensing range			12 m 39.370 ft	3 m 9.843 ft (Note 1)	1.5 m 4.921 ft (Note 1)	120 mm 4.724 in (Note 2)
Sensing object			φ8 mm φ0.315 in or more opaque object	φ50 mm φ1.969 in or more opaque or translucent object (Note 1)	φ50 mm φ1.969 in or more opaque, translucent or specular object (Note 1)	Opaque, translucent or transparent object
Hysteresis			—————			15 % or less of operation distance
Repeatability (perpendicular to sensing axis)			0.1 mm 0.004 in or less			0.3 mm 0.012 in or less
Supply voltage			10 to 30 V DC Ripple P-P 10 % or less			
Current consumption			Emitter: 20 mA or less Receiver: 25 mA or less	25 mA or less		
Output			<NPN output type> NPN open-collector transistor <ul style="list-style-type: none"> <li>• Maximum sink current: 100 mA</li> <li>• Applied voltage: 30 V DC or less (between output and 0 V)</li> <li>• Residual voltage: 1.5 V or less (at 100 mA sink current)</li> </ul>		<PNP output type> PNP open-collector transistor <ul style="list-style-type: none"> <li>• Maximum source current: 100 mA</li> <li>• Applied voltage: 30 V DC or less (between output and + V)</li> <li>• Residual voltage: 1.5 V or less (at 100 mA source current)</li> </ul>	
Utilization category			DC-12 or DC-13			
Output operation			Selectable either Light-ON or Dark-ON by the control input			
Short-circuit protection			Incorporated			
Response time			2 ms or less			
Test input (emission halt) function			Incorporated	—————		
Operation indicator			Red LED (lights up when the output is ON)			
Emission indicator			Red LED (lights up during beam emission)	—————		
Pollution degree			3 (Industrial environment)			
Protection			IP67 (IEC)			
Ambient temperature			- 25 to + 55 °C - 13 to + 131 °F (No dew condensation or icing allowed), Storage: - 30 to + 70°C - 22 to + 158 °F			
Ambient humidity			35 to 85 % RH, Storage: 35 to 85 % RH			
Ambient illuminance			Sunlight: 10,000 lx at the light-receiving face, Incandescent light: 3,000 lx at the light-receiving face			
EMC			EN 50081-2, EN 50082-2, EN 60947-5-2			
Voltage withstandability			1,000 V AC for one min. between all supply terminals connected together and enclosure			
Insulation resistance			20 MΩ, or more, with 250 V DC megger between all supply terminals connected together and enclosure			
Vibration resistance			10 to 500 Hz frequency, 1.5 mm 0.059 in amplitude (10 G max.) in X, Y and Z directions for two hours each			
Shock resistance			500 m/s <sup>2</sup> acceleration (50 G approx.) in X, Y and Z directions for three times each			
Emitting element			Infrared LED (modulated)	Red LED (modulated)	Infrared LED (modulated)	
Material			Enclosure: PBT, Lens: Polycarbonate		Enclosure: PBT, Front cover: Acrylic	
Cable			0.34 mm <sup>2</sup> 4-core (thru-beam type emitter: 3-core) cabtyre cable, 2 m 6.562 ft long			
Cable extension			Extension up to total 100 m 328.084 ft is possible with 0.34 mm <sup>2</sup> , or more, cable (thru-beam type: both emitter and receiver).			
Weight			Emitter: 90 g approx. Receiver: 100 g approx.	100 g approx.		
Accessories			Nut: 4 pcs.		Nut: 2 pcs.	

**NOTE: Reflector is not supplied with the retroreflective type sensor. Please select the suitable reflector or reflective tape from the options.**

Notes: 1) The sensing range and the sensing object of the retroreflective type sensor are specified for the **RF-230** reflector (optional).

2) The sensing range of the diffuse reflective type sensor is specified for white non-glossy paper (200 × 200 mm 7.874 × 7.874 in) as the object.

## SPECIFICATIONS

### AC supply type

Item	Model No.	Type	Retroreflective			Diffuse reflective
			Thru-beam	With polarizing filters		
				Light-ON	CY-17A	
Dark-ON	CY-11B	CY-17B	CY-19B	CY-12B		
Sensing range		12 m 39.370 ft	3 m 9.843 ft (Note 1)	1.5 m 4.921 ft (Note 1)	120 mm 4.724 in (Note 2)	
Sensing object		φ 8 mm φ 0.315 in or more opaque object	φ 50 mm φ 1.969 in or more opaque or translucent object (Note 1)	φ 50 mm φ 1.969 in or more opaque, translucent or specular object (Note 1)	Opaque, translucent or transparent object	
Hysteresis		—————			15 % or less of operation distance	
Repeatability (perpendicular to sensing axis)		0.1 mm 0.004 in or less			0.3 mm 0.012 in or less	
Supply voltage		24 to 240 V AC ± 10 %				
Power consumption		Emitter: 1.5 VA or less Receiver: 2.5 VA or less	2.7 VA or less			
Output		AC non-contact (thyristor) output • Load current: 5 to 200 mA • Applied voltage: 24 to 240 V AC ± 10 % • Residual voltage: 4 V AC or less (at 200 mA load current)				
Response time		20 ms or less				
Operation indicator		Red LED (lights up when the output is ON), incorporated on the receiver for the thru-beam type sensor				
Power indicator		Red LED (lights up when the power is ON), incorporated on the emitter	—————			
Environmental resistance	Pollution degree		3 (Industrial environment)			
	Protection		IP67 (IEC)			
	Ambient temperature		− 25 to + 55 °C − 13 to + 131 °F (No dew condensation or icing allowed), Storage: − 30 to + 70 °C − 22 to + 158 °F			
	Ambient humidity		35 to 85 % RH, Storage: 35 to 85 % RH			
	Ambient illuminance		Sunlight: 10,000 lx at the light-receiving face, Incandescent light: 3,000 lx at the light-receiving face			
	EMC		EN 50081-2, EN 50082-2, EN 60947-5-2			
	Voltage withstandability		1,500 V AC for one min. between all supply terminals connected together and enclosure			
	Insulation resistance		20 MΩ, or more, with 500 V DC megger between all supply terminals connected together and enclosure			
	Vibration resistance		10 to 500 Hz frequency, 1.5 mm 0.059 in amplitude (10 G max.) in X, Y and Z directions for two hours each			
	Shock resistance		500 m/s <sup>2</sup> acceleration (50 G approx.) in X, Y and Z directions for three times each			
Emitting element		Infrared LED (modulated)	Red LED (modulated)	Infrared LED (modulated)		
Material		Enclosure: PBT, Lens: Polycarbonate	Enclosure: PBT, Front cover: Acrylic			
Cable		0.34 mm <sup>2</sup> 3-core (thru-beam type emitter: 2-core) cabtyre cable, 2 m 6.562 ft long				
Cable extension		Extension up to total 100 m 328.084 ft is possible with 0.34 mm <sup>2</sup> , or more, cable (thru-beam type: both emitter and receiver).				
Weight		Emitter: 90 g approx. Receiver: 100 g approx.	100 g approx.			
Accessories		Nut: 4 pcs.			Nut: 2 pcs.	

**NOTE: Reflector is not supplied with the retroreflective type sensor. Please select the suitable reflector or reflective tape from the options.**

Notes: 1) The sensing range and the sensing object of the retroreflective type sensor are specified for the **RF-230** reflector (optional).  
 2) The sensing range of the diffuse reflective type sensor is specified for white non-glossy paper (200 × 200 mm 7.874 × 7.874 in) as the object.

## I/O CIRCUIT AND WIRING DIAGRAMS

### NPN output type

#### I/O circuit diagram

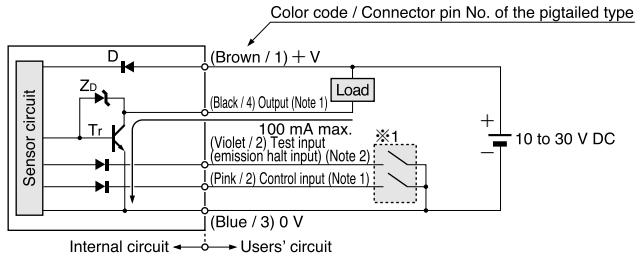

- Notes: 1) The emitter of the thru-beam type sensor does not incorporate the output and the control input. When the mating cable is connected to the pigtailed type, the color of the control input wire is white.
- 2) Test input (emission halt input) is incorporated only on the emitter of the thru-beam type sensor. When the mating cable is connected to the pigtailed type, its color is white.

Symbols ... D : Reverse supply polarity protection diode  
 Zp : Surge absorption zener diode  
 Tr : NPN output transistor

#### Wiring diagram

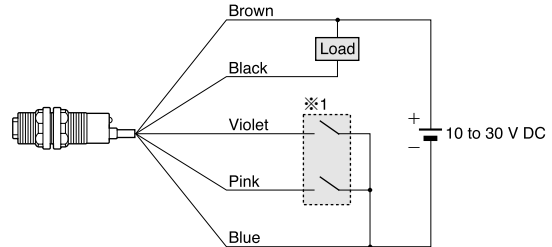

#### Connector pin position (Pigtailed type)

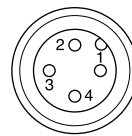

- 1: + V  
 2: Test input (emission halt input) or control input  
 3: 0 V  
 4: Output or not connected

※1

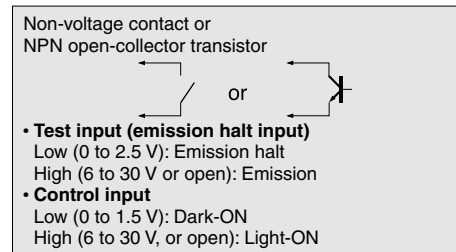

Note: If opening the input cable, make sure to insulate it.

### PNP output type

#### I/O circuit diagram

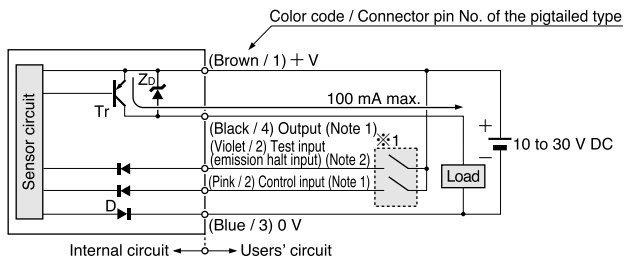

- Notes: 1) The emitter of the thru-beam type sensor does not incorporate the output and the control input. When the mating cable is connected to the pigtailed type, the color of the control input wire is white.
- 2) Test input (emission halt input) is incorporated only on the emitter of the thru-beam type sensor. When the mating cable is connected to the pigtailed type, its color is white.

Symbols ... D : Reverse supply polarity protection diode  
 Zp : Surge absorption zener diode  
 Tr : PNP output transistor

#### Wiring diagram

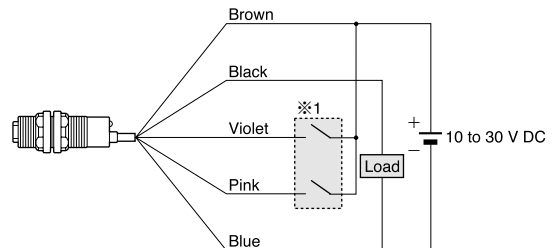

#### Connector pin position (Pigtailed type)

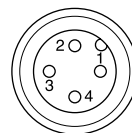

- 1: + V  
 2: Test input (emission halt input) or control input  
 3: 0 V  
 4: Output or not connected

※1

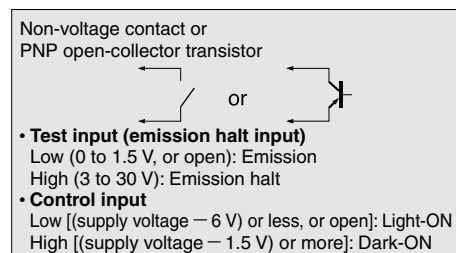

Note: If opening the input cable, make sure to insulate it.



## I/O CIRCUIT AND WIRING DIAGRAMS

### AC non-contact output type

#### I/O circuit diagrams

##### Emitter of thru-beam type sensor

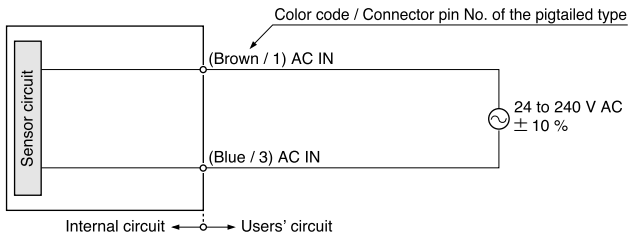

##### Receiver of thru-beam type sensor, retroreflective & diffuse reflective type sensors

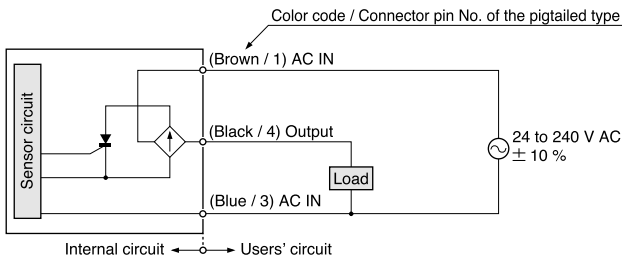

#### Wiring diagrams

##### Emitter of thru-beam type sensor

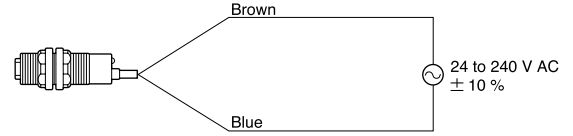

##### Receiver of thru-beam type sensor, retroreflective & diffuse reflective type sensors

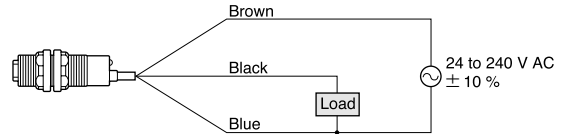

#### Connector pin position (Pigtailed type)

##### Emitter of thru-beam type sensor

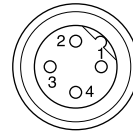

- 1: AC IN
- 2: Not connected
- 3: AC IN
- 4: Not connected

##### Receiver of thru-beam type sensor, retroreflective & diffuse reflective type sensors

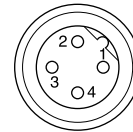

- 1: AC IN
- 2: Not connected
- 3: AC IN
- 4: Output

## SENSING CHARACTERISTICS (TYPICAL)

### All models

#### Correlation between setting distance and excess gain

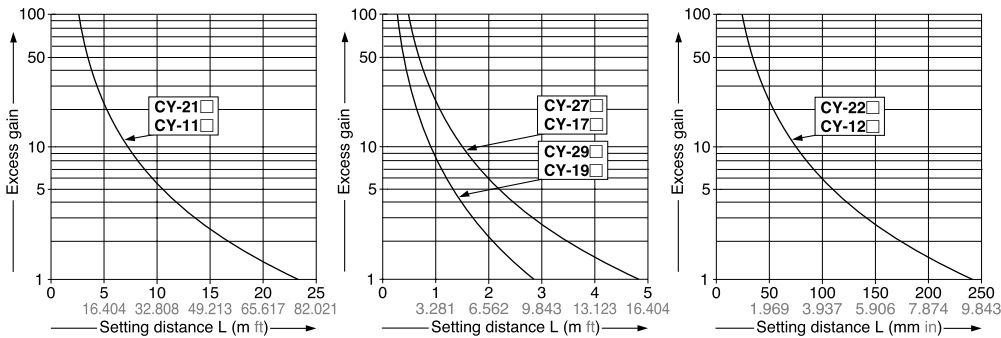

#### CY-21 CY-11

#### Thru-beam type

##### Parallel deviation

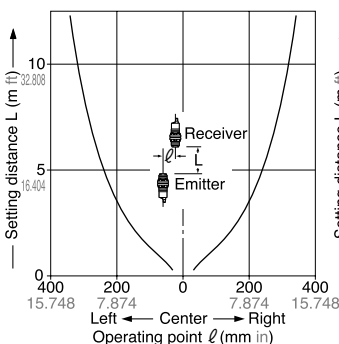

##### Angular deviation

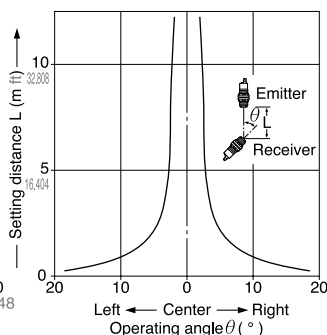

#### CY-27 CY-17

#### Retroreflective type

##### Parallel deviation

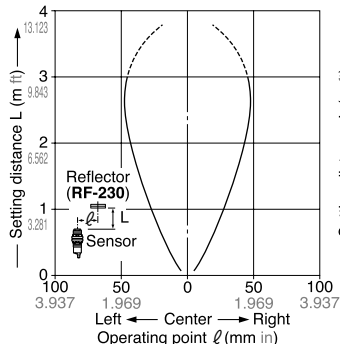

##### Angular deviation

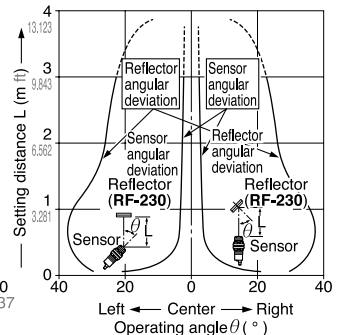

## SENSING CHARACTERISTICS (TYPICAL)

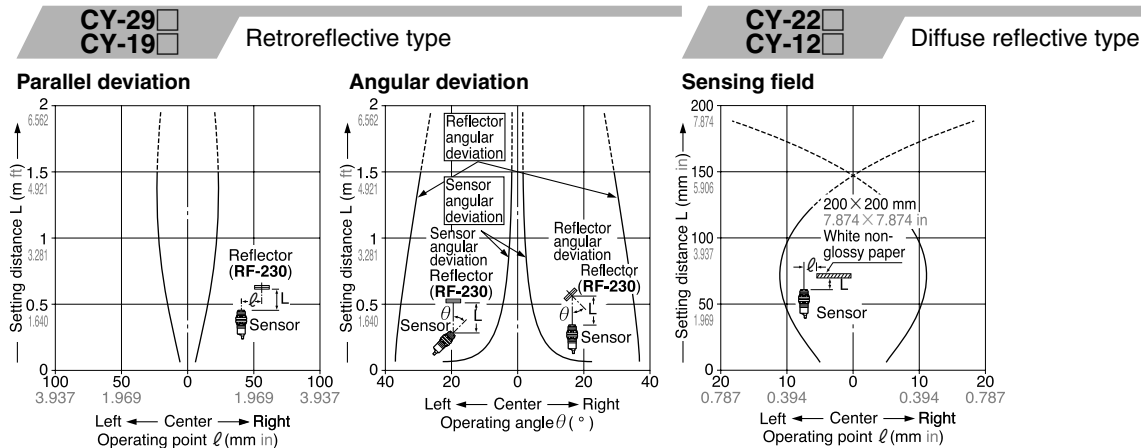

## PRECAUTIONS FOR PROPER USE

This product is not a safety sensor. Its use is not intended or designed to protect life and prevent body injury or property damage from dangerous parts of machinery. It is a normal object detection sensor.

### Mounting

- The tightening torque should be 2 N·m or less.

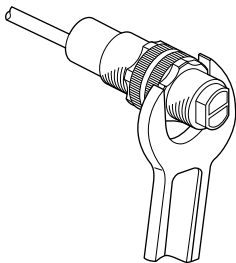

### Retroreflective type sensor with polarizing filters (CY-29□ and CY-19□)

- If a shiny object is covered or wrapped with a transparent film, such as those described below, the retroreflective type sensor with polarizing filters may not be able to detect it. In that case, follow the steps given below.

#### Example of sensing objects

- Can wrapped by clear film
- Aluminum sheet covered by plastic film
- Gold or silver color (specular) label or wrapping paper

#### Steps

- Tilt the sensor with respect to the sensing object while fitting.
- Increase the distance between the sensor and the sensing object.

### Retroreflective type sensor (CY-27□ and CY-17□)

- Please take care of the following points when detecting materials having a gloss.

- Make L, shown in the diagram, sufficiently long.
- Install at an angle of 10 to 30 degrees to the sensing object.

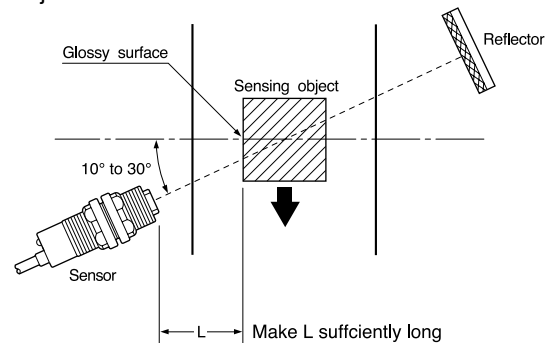

※CY-29□ and CY-19□ do not need the above adjustment.

### Others

- Do not use during the initial transient time (50 ms) after the power supply is switched on.

## DIMENSIONS (Unit: mm in)

**CY-21** **CY-27**  
**CY-22** Sensor

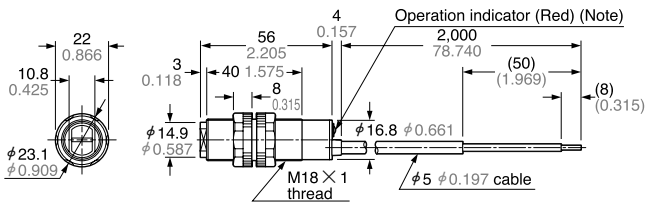

Note: It is the emitting indicator (red) on the emitter of the thru-beam type sensor.

**CY-21-J** **CY-27-J**  
**CY-22-J** Sensor

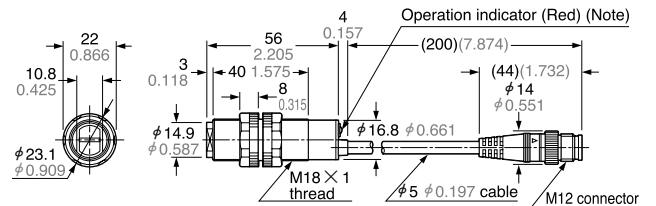

Note: It is the emitting indicator (red) on the emitter of the thru-beam type sensor.

**CY-29** Sensor

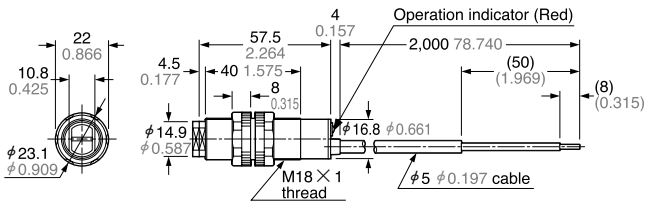

**CY-29-J** Sensor

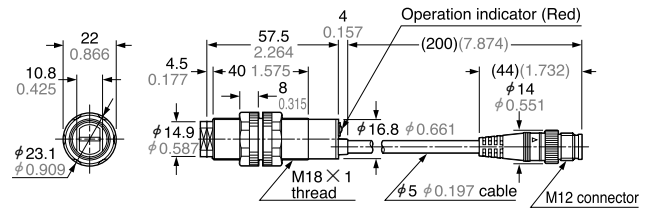

**CY-11** **CY-17**  
**CY-12** Sensor

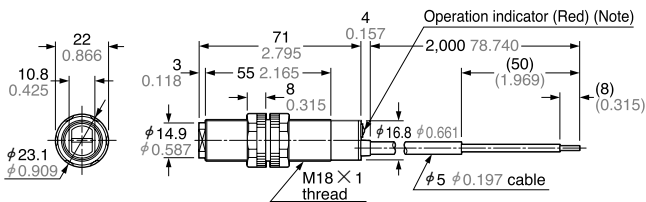

Note: It is the power indicator (red) on the emitter of the thru-beam type sensor.

**CY-11-J** **CY-17-J**  
**CY-12-J** Sensor

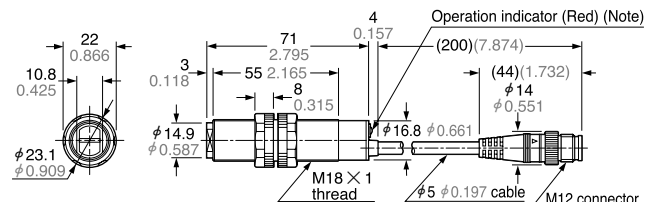

Note: It is the power indicator (red) on the emitter of the thru-beam type sensor.

**CY-19** Sensor

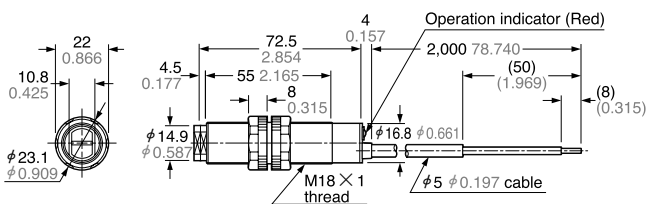

**CY-19-J** Sensor

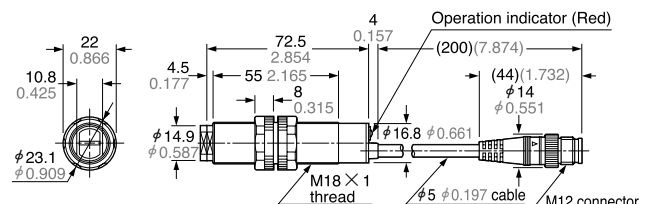

**RF-210** Reflector (Optional)

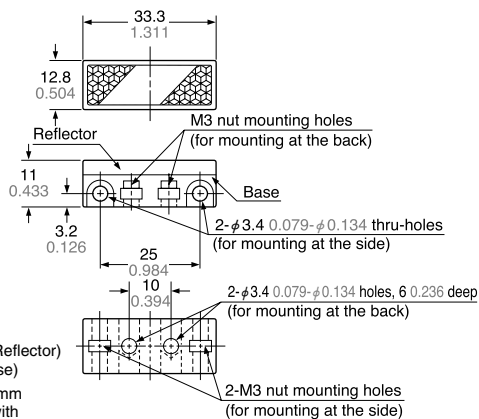

Material: Acrylic (Reflector)  
ABS (Base)  
Two M3 (length 8 mm  
0.315 in) screws with  
washers and two nuts are  
attached.

**RF-220** Reflector (Optional)

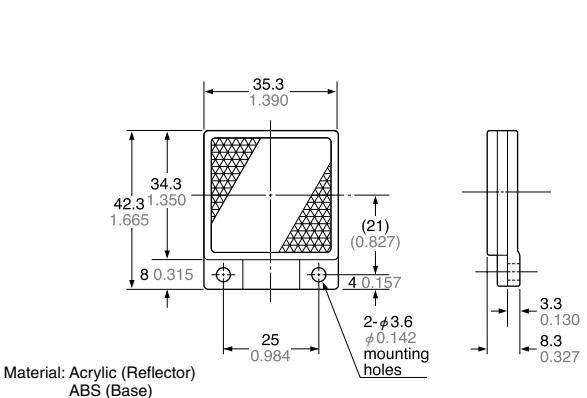

Material: Acrylic (Reflector)  
ABS (Base)

## DIMENSIONS (Unit: mm in)

### RF-230 Reflector (Optional)

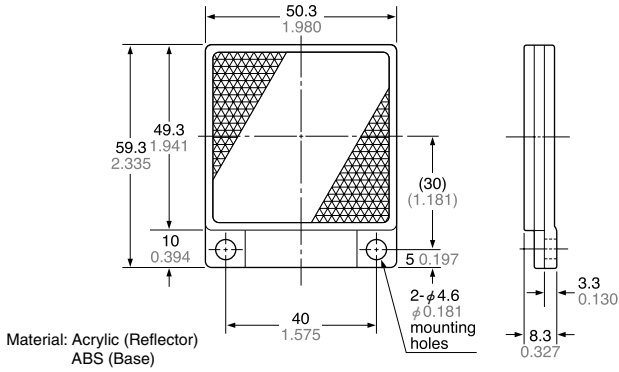

### RF-11 Reflective tape (Optional)

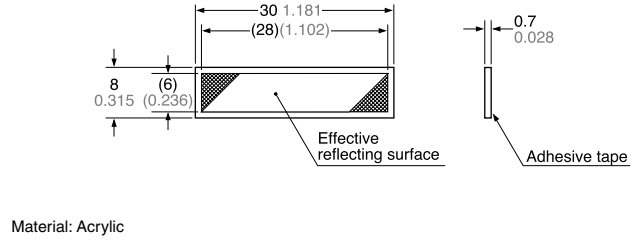

### RF-12 Reflective tape (Optional)

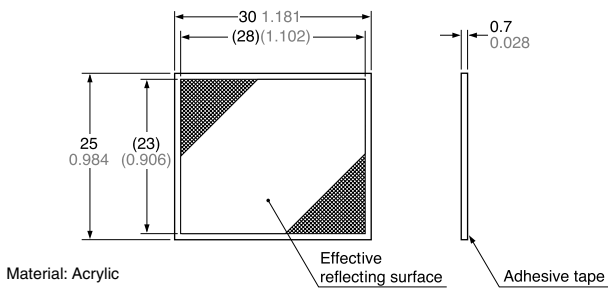

### MS-RF21-1 Reflector mounting bracket for RF-210 (Optional)

#### Assembly dimensions

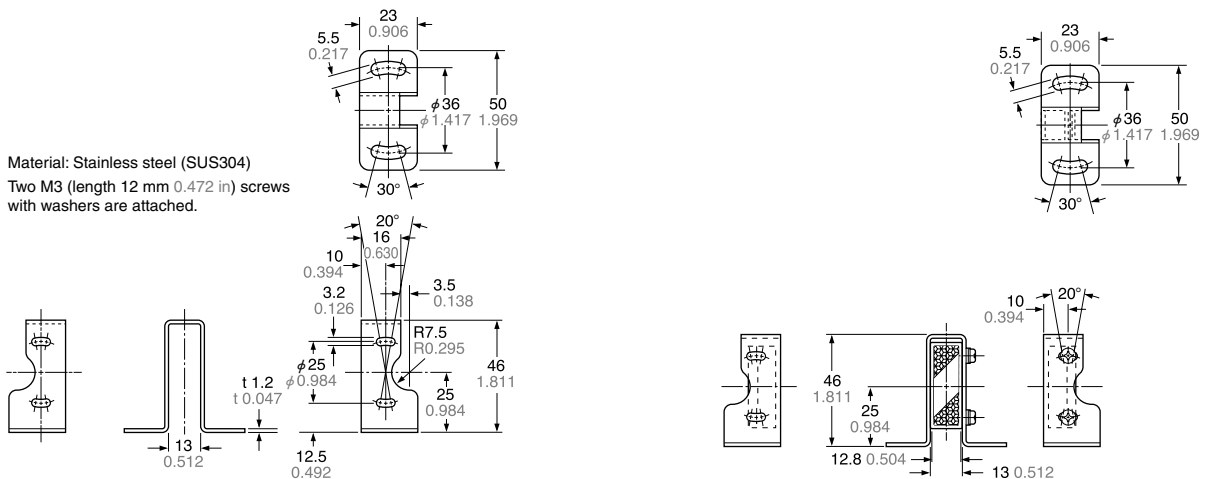

## DIMENSIONS (Unit: mm in)

### MS-RF22 Reflector mounting bracket for RF-220 (Optional)

#### Assembly dimensions

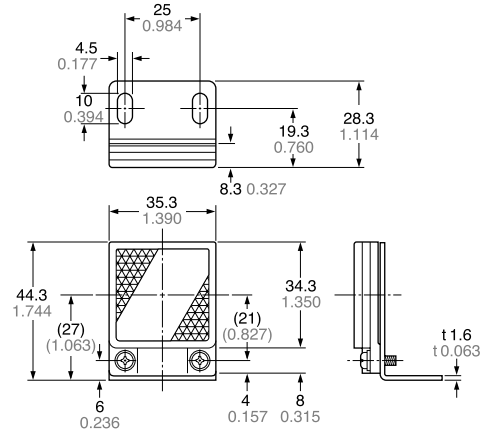
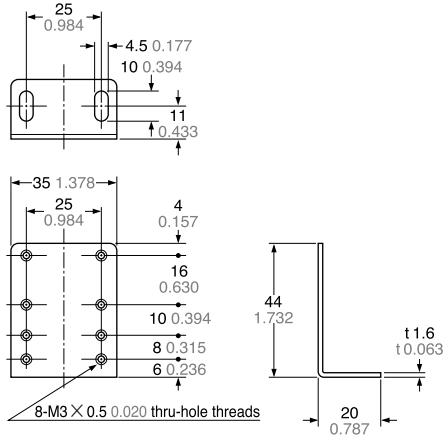

Material: Cold rolled carbon steel (SPCC)  
(Uni-chrome plated)

Two M3 (length 8 mm 0.315 in) screws with washers are attached.

### MS-RF23 Reflector mounting bracket for RF-230 (Optional)

#### Assembly dimensions

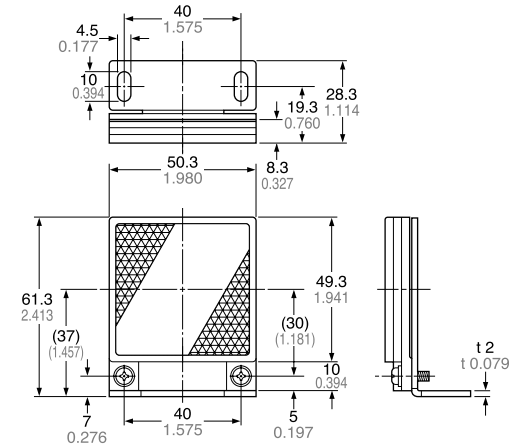
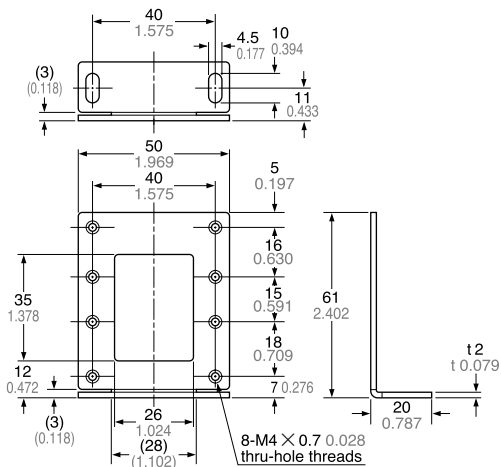

Material: Cold rolled carbon steel (SPCC)  
(Uni-chrome plated)

Two M4 (length 10 mm 0.394 in) screws with washers are attached.