

阅读申明

- 1.本站收集的数据手册和产品资料都来自互联网，版权归原作者所有。如读者和版权方有任何异议请及时告之，我们将妥善解决。
- 2.本站提供的中文数据手册是英文数据手册的中文翻译，其目的是协助用户阅读，该译文无法自动跟随原稿更新，同时也可能存在翻译上的不当。建议读者以英文原稿为参考以便获得更精准的信息。
- 3.本站提供的产品资料，来自厂商的技术支持或者使用者的心得体会等，其内容可能存在描述上的差异，建议读者做出适当判断。
- 4.如需与我们联系，请发邮件到marketing@iczoom.com，主题请标有“数据手册”字样。

Read Statement

1. The datasheets and other product information on the site are all from network reference or other public materials, and the copyright belongs to the original author and original published source. If readers and copyright owners have any objections, please contact us and we will deal with it in a timely manner.
2. The Chinese datasheets provided on the website is a Chinese translation of the English datasheets. Its purpose is for reader's learning exchange only and do not involve commercial purposes. The translation cannot be automatically updated with the original manuscript, and there may also be improper translations. Readers are advised to use the English manuscript as a reference for more accurate information.
3. All product information provided on the website refer to solutions from manufacturers' technical support or users the contents may have differences in description, and readers are advised to take the original article as the standard.
4. If you have any questions, please contact us at marketing@iczoom.com and mark the subject with "Datasheets" .

DP3 SERIES

Digital Pressure Sensor with Auto-reference Function



High accuracy sensing at all times with auto-reference function

* Passed the UL 991 Environment Test



* UL 61010C-1 compatible, Passed the UL 991 Environment Test based on SEMI S2-0200.
[Category applicable for semiconductor manufacturing: TWW2, Process Equipment]
[Applicable standards: UL 61010C-1]
[Additional test / evaluation standards as per intended use: UL991, SEMI S2-0200]

Incorporates auto-reference function

• Unaffected by changes in reference pressure

By an external signal, the set (threshold) values are corrected by being shifted by an amount equal to the pressure change. Hence, judgment by the sensor is as accurate as before the reference pressure change. This function is extremely suitable in places having intense variations in the reference pressure or where fine settings are required.

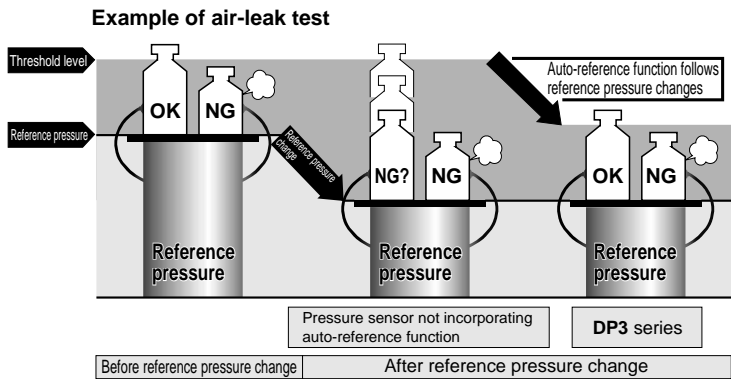

• Total cost reduction

Till now...one sensor was required for each suction nozzle

Since the threshold level differs with the suction nozzle, a sensor was required for each suction nozzle, increasing the cost significantly.

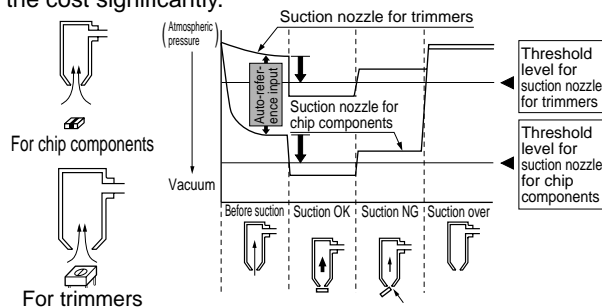

In case of DP3...operation efficiency UP!

Since the threshold level can be automatically changed by the auto-reference function, two suction nozzles can be used, alternately, with one sensor.

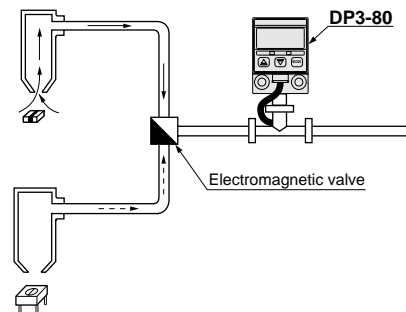

Two outputs with four independent settings and four output modes enable control as per your requirement

1 Hysteresis mode

The hysteresis of the comparative outputs can be set, as desired, with the set values.

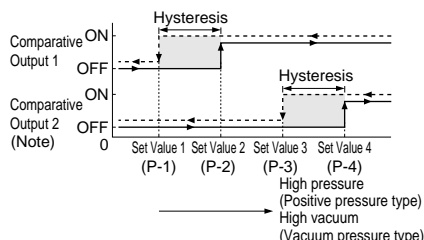

Note: The auto-reference function acts only on Set Value 3 (P-3) and Set Value 4 (P-4) of Comparative Output 2.

2 Window comparator mode

The comparative outputs can be made ON or OFF by a pressure within the set range.

Since Comparative Output 1 can be used as a self-diagnosis output, it is possible to specify the auto-reference input range.

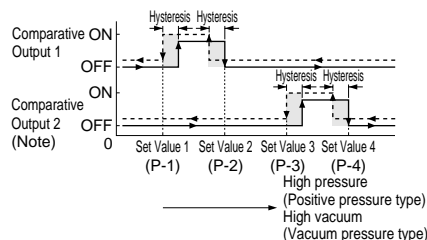

Note: The auto-reference function acts only on Set Value 3 (P-3) and Set Value 4 (P-4) of Comparative Output 2.

3 Leak test mode

Optimum for leak test

This mode is optimally suitable for a leak test since Comparative Output 1 can be set to the hysteresis mode and Comparative Output 2 can be set to the window comparator mode.

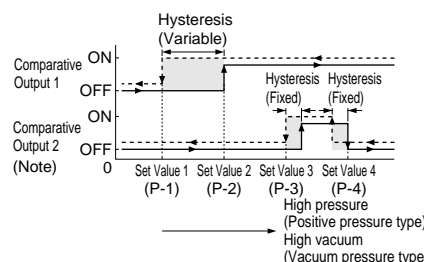

Note: The auto-reference function acts only on Set Value 3 (P-3) and Set Value 4 (P-4) of Comparative Output 2.

4 Forced output mode

Suitable for start-up check

The comparative outputs are forcibly maintained in the OFF state in the sensing mode, irrespective of the set values.

Also, since the comparative outputs can be forcibly made ON or OFF with key operation, without actually applying pressure, this mode is suitable for an operation check or a start-up check.

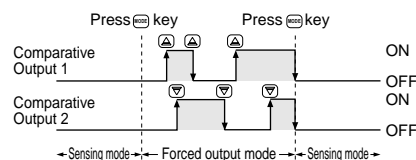

High accuracy • high resolution • high speed

It achieves a 2.5 ms, or less, response time at a high resolution of 1/1,000. It enables highly accurate sensing with its excellent repeatability and temperature characteristics.

Response time

2.5 ms or less

Repeatability

Within $\pm 0.2\%$ F.S. ± 1 digit

Temperature characteristics

Within $\pm 1\%$ F.S.

Note: The response time is 7.5 ms, or less, at the time of auto-reference input.

A wide variety of models

Selection can be made according to mounting method or place of use.

Standard type / DP3-2

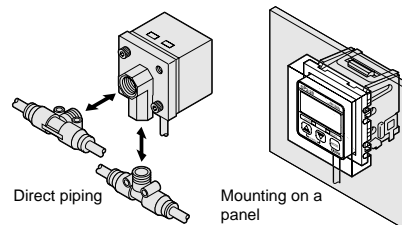

Flat type / DP3-4

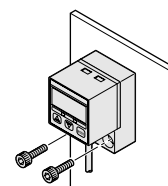

Direct mounting on a wall

Light weight type / DP3-80

Total weight 70 g approx.

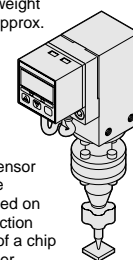

The sensor can be mounted on the suction head of a chip mounter.

Selection from six pressure units

The pressure unit can be selected from six different systems to suit your requirement.

(The selectable pressure units differ with the sensor type. When the pressure unit is changed, the measured pressure value and the set values are automatically converted.)

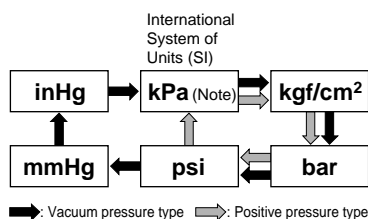

Note: 'MPa' in case of DP3-22 and DP3-42.

Analog bar display

Pressure changes can also be displayed in an analog fashion using LED bars. Hence, sudden pressure changes can be recognized at a glance.

(LED bars indicate the pressure level in steps of 10 % F.S., regardless of the pressure unit.)



Peak hold / bottom hold display

The peak value or the bottom value of the varying pressure can be displayed. This function is convenient for finding the pressure variation range or for determining a reference for pressure settings.

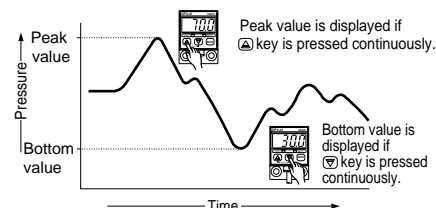

Note: The above graph is for a positive pressure type sensor.

APPLICATIONS

Confirmation of chip component suction

The auto-reference function can compensate for the difference in suction levels due to suction nozzle separation distance. The vacuum type can be mounted close to the chip moulder suction head since it weighs only 70 g.

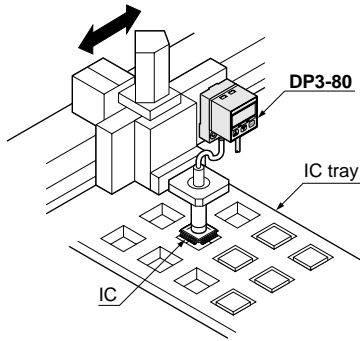

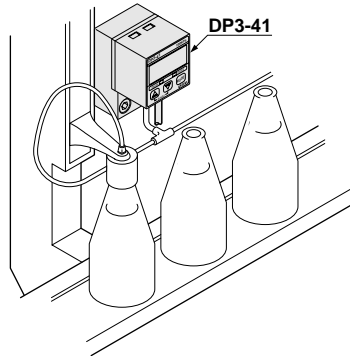

Air-leak test for PET bottles

Leak test mode, which is an output mode optimally suitable for an air-leak test, has been incorporated. It can reliably detect even a small air-leak. Because of the auto-reference function, it is safe even if the filling pressure varies.



ORDER GUIDE

Type		Appearance	Rated pressure range	Model No.	Pressure port	Comparative outputs
Standard	Vacuum pressure — 101 kPa type		0 to — 101.3 kPa	DP3-20	Rc (PT) 1/8 female thread	NPN open-collector transistor
	Positive pressure 100 kPa type		0 to 100.0 kPa	DP3-21		
	Positive pressure 1 MPa type		0 to 1.000 MPa	DP3-22		
Flat	Light weight Vacuum pressure — 101 kPa type		0 to — 101.3 kPa	DP3-80	M5 female thread	
			Positive pressure 100 kPa type	0 to 100.0 kPa	DP3-41	
	Positive pressure 1 MPa type		0 to 1.000 MPa	DP3-42		

OPTIONS

Designation	Model No.	Description
Sensor mounting bracket (For standard type)	MS-DPX	Mounting bracket for standard type [Two M4 (length 6 mm 0.236 in) pan head screws and two spring washers are attached.]
	MS-DPX-4	Back angled mounting bracket for standard type [Two M4 (length 6 mm 0.236 in) pan head screws and two spring washers are attached.]
Straight bush	DPX-03	Changes the pressure port from female thread [Rc (PT) 1/8] to male thread [R (PT) 1/8].
Panel mounting bracket (For standard type)	MS-DPX-2	It can be used for mounting on a panel (1 to 3.2 mm 0.039 to 0.126 in thick).
Front protection cover (For standard type)	DPX-04	It protects the sensor's adjustment panel. (It can be fitted when the panel mounting bracket is used.)

Accessories

- **DPX-01** [Pressure port attachment (Standard type only)]
- **DPX-02** [Hexagon-socket-head plug for pressure port (Standard type only)]

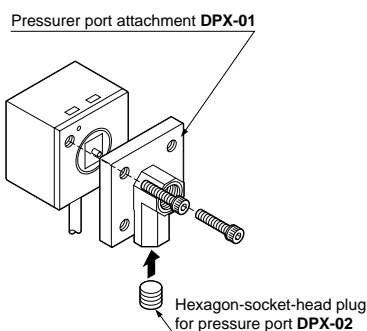

Sensor mounting bracket

- **MS-DPX**

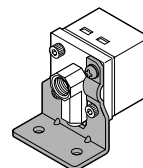

Two M4 (length 6 mm 0.236 in) pan head screws and two spring washers are attached.

- **MS-DPX-4**

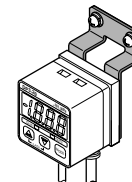

Two M4 (length 6 mm 0.236 in) pan head screws and two spring washers are attached.

Straight bush

- **DPX-03**

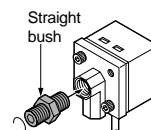

Panel mounting bracket, Front protection cover

- **MS-DPX-2**
- **DPX-04**

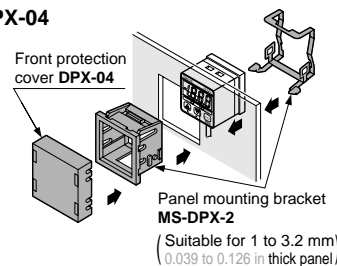

SPECIFICATIONS

Item	Model No.	Vacuum pressure		Positive pressure			
		- 101 kPa type		100 kPa type		1 MPa type	
		Standard	Light weight	Standard	Flat	Standard	Flat
		DP3-20	DP3-80	DP3-21	DP3-41	DP3-22	DP3-42
Type of pressure		Gauge pressure					
Rated pressure range		0 to - 101.3 kPa		0 to 100.0 kPa		0 to 1.000 MPa	
Set pressure range (Note 1)		5.1 to - 101.3 kPa { 0.052 to - 1.033 kgf/cm ² , 0.051 to - 1.013 bar 0.74 to - 14.70 psi, 38 to - 760 mmHg 1.5 to - 29.9 inHg }		- 5.0 to 100.0 kPa { - 0.051 to 1.020 kgf/cm ² , - 0.050 to 1.000 bar - 0.72 to 14.50 psi }		- 0.050 to 1.000 MPa { - 0.51 to 10.20 kgf/cm ² , - 0.50 to 10.00 bar - 7.2 to 145.0 psi }	
Settable range (Note 2)		101.3 to - 101.3 kPa { 1.033 to - 1.033 kgf/cm ² , 1.013 to - 1.013 bar 14.70 to - 14.70 psi, 760 to - 760 mmHg 29.9 to - 29.9 inHg }		- 100.0 to 100.0 kPa { - 1.020 to 1.020 kgf/cm ² , - 1.000 to 1.000 bar - 14.50 to 14.50 psi }		- 1.000 to 1.000 MPa { - 10.20 to 10.20 kgf/cm ² , - 10.00 to 10.00 bar - 145.0 to 145.0 psi }	
Pressure withstandability		490 kPa				1.47 MPa	
Applicable fluid		Non-corrosive gas					
Selectable units		kPa, kgf/cm ² , bar, psi, mmHg, inHg		kPa, kgf/cm ² , bar, psi		MPa, kgf/cm ² , bar, psi	
Supply voltage		12 to 24 V DC $\pm 10\%$ Ripple P-P 10 % or less					
Current consumption		50 mA or less					
Comparative outputs (Comparative Output 1) (Comparative Output 2)		NPN open-collector transistor • Maximum sink current: 100 mA • Applied voltage: 30 V DC or less (between comparative output and 0 V) • Residual voltage: 1 V or less (at 100 mA sink current) 0.4 V or less (at 16 mA sink current)					
Utilization category		DC-12 or DC-13					
Output modes		Equipped with 4 types of modes: hysteresis mode, window comparator mode, leak test mode, forced output mode (selectable by key operation)					
Hysteresis		1 digit (however, variable in hysteresis mode, variable for Comparative Output 1 only when using leak test mode, and 2 digits when using psi unit)					
Repeatability		Within $\pm 0.2\%$ F.S. ± 1 digit					
Response time		2.5 ms or less [7.5 ms or less with auto-reference input (Note 3)]					
Short-circuit protection		Incorporated					
Auto-reference input		NPN non-contact input [operates in Low (fall) state] • Input signal condition: High...5 to 30 V or open Low...0.4 V or less (0.5 mA, or less, source current) Low level input time...1 ms or more Reference pressure duration...1 ms or more					
Display		3 1/2 digit red LED display (Sampling rate: 4 times/sec. approx.)					
Displayable pressure range		5.1 to - 101.3 kPa { 0.052 to - 1.033 kgf/cm ² , 0.051 to - 1.013 bar 0.74 to - 14.70 psi, 38 to - 760 mmHg 1.5 to - 29.9 inHg }		- 5.0 to 100.0 kPa { - 0.051 to 1.020 kgf/cm ² , - 0.050 to 1.000 bar - 0.72 to 14.50 psi }		- 0.050 to 1.000 MPa { - 0.51 to 10.20 kgf/cm ² , - 0.50 to 10.00 bar - 7.2 to 145.0 psi }	
Analog bar display		LED bar display in steps of 10 % F.S. approx.					
Operation indicators	Comparative Output 1	Orange LED (lights up when Comparative Output 1 is ON)					
	Comparative Output 2	Green LED (lights up when Comparative Output 2 is ON)					
Environmental resistance	Pollution degree	3 (Industrial environment)					
	Protection	IP40 (IEC)					
	Ambient temperature	- 10 to + 50 °C + 14 to + 122 °F (No dew condensation or icing allowed), Storage: - 10 to + 60 °C + 14 to + 140 °F					
	Ambient humidity	35 to 85 % RH, Storage: 35 to 85 % RH					
	EMC	EN 50081-2, EN 50082-2, EN 61000-6-2					
	Voltage withstandability	1,000 V AC for one min. between all supply terminals connected together and enclosure					
	Insulation resistance	50 M Ω , or more, with 500 V DC megger between all supply terminals connected together and enclosure					
Vibration resistance	10 to 150 Hz frequency, 0.75 mm 0.030 in amplitude in X, Y and Z directions for two hours each						
Shock resistance	100 m/s ² acceleration (10 G approx.) in X, Y and Z directions for three times each						
Temperature characteristics		Over ambient temperature range - 10 to + 50 °C + 14 to + 122 °F: within $\pm 1\%$ F.S. of detected pressure at + 20 °C + 68 °F					
Pressure port		Standard type: Rc (PT) 1/8 female thread, Flat type: Rc (PT) 1/8 female thread, Light weight type: M5 female thread					
Material		Front case: ABS, Rear case: PPS (glass fiber reinforced), Display surface: Acrylic Pressure port attachment: Die-cast zinc alloy [Light weight type: POM (glass fiber reinforced), pressure port is brass (nickel plated)]					
Cable		0.15 mm ² 5-core oil resistant cabtyre cable, 2 m 6.562 ft long					
Cable extension		Extension up to total 100 m 328.084 ft (less than 10 m 32.808 ft when conforming to CE marking) is possible with 0.3 m ² , or more, cable.					
Weight		Standard type: 95 g approx., Flat type: 120 g approx., Light weight type: 70 g approx.					
Accessories		DPX-02 (Hexagon-socket-head plug for pressure port): 1 pc. (Standard type only), Pressure unit label: 1 pc.					

Notes: 1) The set pressure range is the settable pressure range for Set Value 1 (P-1) and Set Value 2 (P-2).
 2) The settable range is the settable pressure range for Set Value 3 (P-3) and Set Value 4 (P-4). It caters to the auto-reference function and is much wider than the rated pressure range.
 3) Refer to 'Time chart' under 'Auto-reference function' on p.816.

I/O CIRCUIT AND WIRING DIAGRAMS

I/O circuit diagram

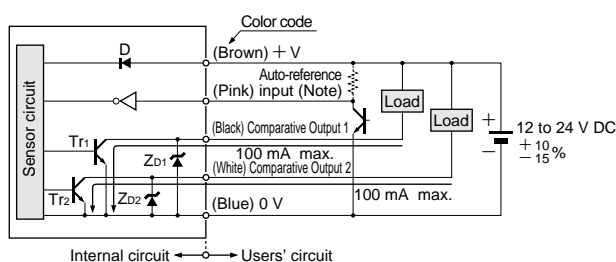

Note: If you do not use the auto-reference input (pink), always connect it to +V (brown).

Symbols ... D: Reverse supply polarity protection diode
 ZD1, ZD2: Surge absorption zener diode
 Tr1, Tr2: NPN output transistor

Wiring diagram

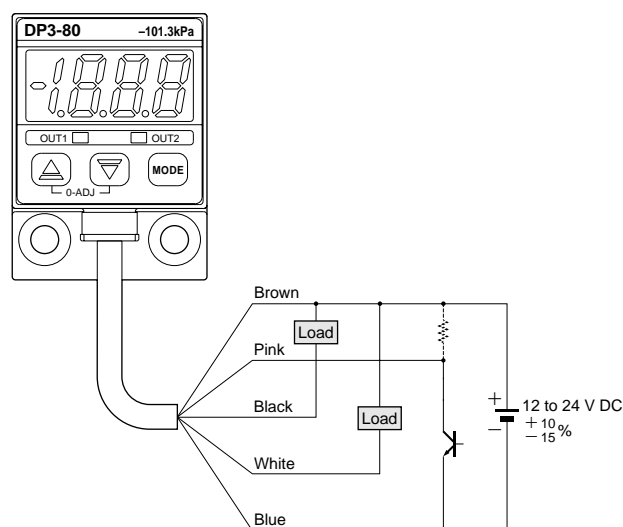

PRECAUTIONS FOR PROPER USE

All models



- This product is not a safety sensor. Its use is not intended or designed to protect life and prevent body injury or property damage from dangerous parts of machinery. It is a normal pressure detection sensor.
- The DP3 series is designed for use with non-corrosive gas. It cannot be used with liquid or corrosive gas.

Operation

- If setting is impossible even with pressing the MODE key, verify whether the key-protect function is enabled. Please note that pressing down on the MODE key for an extended moment will enable the key-protect function as soon as the key is released.
- If using the window comparator mode, set the pressure values so that there is a difference of 3 digits, or more, between Set Value 1 (P-1) and Set Value 2 (P-2), and between Set Value 3 (P-3) and Set Value 4 (P-4). No output will be possible with a 0 to 2 digit difference.

Wiring

- Make sure that the power supply is off while wiring.
- Verify that the supply voltage variation is within the rating.
- If power is supplied from a commercial switching regulator, ensure that the frame ground (F.G.) terminal of the power supply is connected to an actual ground.
- In case noise generating equipment (switching regulator, inverter motor, etc.) is used in the vicinity of this sensor, connect the frame ground (F.G.) terminal of the equipment to an actual ground.
- Do not run the wires together with high-voltage lines or power lines or put them in the same raceway. This can cause malfunction due to induction.

Conditions in use for CE conformity

- The DP3 series is a CE conformity product complying with EMC Directive. The harmonized standard with regard to immunity that applies to this product is EN 61000-6-2 (Note) and the following condition must be met to conform to that standard.

Condition

- The sensor should be connected less than 10 m 32.808 ft from the power supply.

Note: The EN 50082-2 that previously applied to the products for conforming to EMC Directive was replaced by EN 61000-6-2 starting April 1st, 2002.

Others

- Use within the rated pressure range.
- Do not apply pressure exceeding the pressure with-standability value. The diaphragm will get damaged and correct operation shall not be maintained.
- Do not use during the initial transient time (0.5 sec.) after the power supply is switched on.
- Avoid dust, dirt, and steam.
- Take care that the sensor does not come in direct contact with water, oil, grease, or organic solvents, such as, thinner, etc.
- Do not insert wires, etc., into the pressure port. The diaphragm will get damaged and correct operation shall not be maintained.
- Do not operate the keys with pointed or sharp objects.

DP3

PRECAUTIONS FOR PROPER USE

All models

Functional description

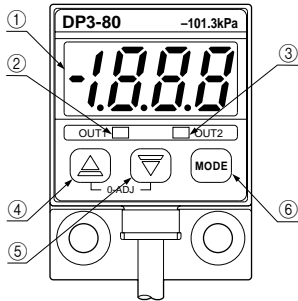

Description	Function
① 3 1/2 digit LED display (Red)	Displays measured pressure, settings, error messages and key-protect status.
② Comparative Output 1 operation indicator (Orange)	Lights up when Comparative Output 1 is ON.
③ Comparative Output 2 operation indicator (Green)	Lights up when Comparative Output 2 is ON.
④ Increment key (▲)	<ul style="list-style-type: none"> In the initial setting mode, pressing the key changes the settable digit. In the Set Value 1 to 4 modes, pressing the key changes the set value to the high pressure side in case of positive pressure type sensor and to the high vacuum side in case of vacuum pressure type sensor. In the sensing mode, if the key is pressed continuously for 4 sec. or more, the display shows peak hold value.
⑤ Decrement key (▼)	<ul style="list-style-type: none"> In the initial setting mode, pressing the key changes the set conditions. In the Set Value 1 to 4 modes, pressing the key changes the set value to the low pressure side in case of positive pressure type sensor and to the low vacuum side in case of vacuum pressure type sensor. In the sensing mode, if the key is pressed continuously for 4 sec. or more, the display shows bottom hold value.
⑥ Mode selection key (MODE)	<ul style="list-style-type: none"> Each press of the key changes the selected mode to sensing mode, Set Value 1 (P-1) to Set Value 4 (P-4) set mode. In the sensing mode, if the key is pressed continuously for about 3 sec., key-protect can be set / released. In the sensing mode, if the mode selection key is pressed while pressing the increment key (▲), the initial setting mode is obtained.

In the sensing mode, if both the keys are pressed simultaneously, zero-point adjustment is done.

Error messages

• When an error occurs, take the following corrective action.

Error message	Cause	Corrective action
	Overcurrent due to short-circuit.	Switch off the power supply and check the load.
	Pressure is being applied during zero-point adjustment.	Applied pressure at the pressure port should be brought to atmospheric pressure and zero-point adjustment should be done again.
	Positive pressure type Applied pressure exceeds the upper limit of displayable pressure range.	Applied pressure should be brought within the rated pressure range.
	Vacuum pressure type Applied pressure exceeds the lower limit of displayable pressure range.	
	Positive pressure type Applied pressure exceeds the lower limit of displayable pressure range.	
	Vacuum pressure type Applied pressure exceeds the upper limit of displayable pressure range.	

Label for change in pressure unit

• When a pressure unit other than 'kPa' (P) or 'MPa' (P) has been selected in the initial setting mode, the label (supplied as accessory) which corresponds to the selected unit should be stuck at the position shown in the figure below.

Pressure unit label (accessory)

—101.3 kPa用	100 kPa用	1 MPa用
—1.033 kgf/cm ²	1.020 kgf/cm ²	10.20 kgf/cm ²
—14.70 psi	14.50 psi	145.0 psi
—1.013 bar	1.000 bar	10.00 bar
—760 mmHg		
—29.9 inHg		

圧力センサ用 単位切り換え銘板 N2L58

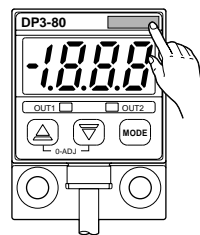

Stick the pressure unit label at the position shown.

Conversion of pressure units

• In the DP3 series, the conversion to different units is automatically done on changing the setting of the pressure unit. However, this conversion can also be obtained by multiplying the values by the coefficients given in the table on the right.

Conversion table for pressure units

	kPa	MPa	kgf/cm ²	bar	psi	mmHg (Torr)	inHg	atm
1 kPa	1	1 × 10 ⁻³	1.01972 × 10 ⁻²	1 × 10 ⁻²	1.45038 × 10 ⁻¹	7.50062	0.2953	9.86923 × 10 ⁻³
1 MPa	1 × 10 ³	1	1.01972 × 10	1 × 10	1.45038 × 10 ²	7.50062 × 10 ³	0.2953 × 10 ³	9.86923
1 kgf/cm ²	9.80665 × 10	9.80665 × 10 ⁻²	1	9.80665 × 10 ⁻¹	1.42234 × 10	7.35559 × 10 ²	2.8959 × 10	9.67841 × 10 ⁻¹
1 bar	1 × 10 ²	1 × 10 ⁻¹	1.01972	1	1.45038 × 10	7.50062 × 10 ²	2.953 × 10	9.86923 × 10 ⁻¹
1 psi	6.89473	6.89473 × 10 ⁻³	7.03065 × 10 ⁻²	6.89473 × 10 ⁻²	1	5.17147 × 10	2.036	6.80457 × 10 ⁻²
1 mmHg (1 Torr)	1.33322 × 10 ⁻¹	1.33322 × 10 ⁻⁴	1.35951 × 10 ⁻³	1.33322 × 10 ⁻³	1.93368 × 10 ⁻²	1	3.9370 × 10 ⁻²	1.31579 × 10 ⁻³
1 inHg	3.3864	3.3864 × 10 ⁻³	3.4531 × 10 ⁻²	3.3864 × 10 ⁻²	0.4912	2.5400 × 10	1	3.342 × 10 ⁻²
1 atm	1.01325 × 10 ²	1.01325 × 10 ⁻¹	1.03323	1.01325	1.46960 × 10	7.60000 × 10 ²	2.9921 × 10	1

Conversion procedure

• For example, if 2 kPa is to be expressed in kgf/cm², since 1 kPa = 1.01972 × 10⁻² kgf/cm², 2 kPa becomes 2 × 1.01972 × 10⁻² = 0.020 kgf/cm².

PRECAUTIONS FOR PROPER USE

All models

Setting

- If key-protect has been set, make sure to release key-protect before operating the keys. (Please refer to 'Key-protect function' on p.817 for the procedure.)
- Set Value 1 to 4 (P-1 to P-4) can be made common for all the output modes.
- In the positive pressure type sensor, Set Value 2 (P-2) and Set Value 4 (P-4) can be set only towards the high pressure side with respect to Set Value 1 (P-1) and Set Value 3 (P-3), respectively.
- In the vacuum pressure type sensor, Set Value 2 (P-2) and Set Value 4 (P-4) can be set only towards the high vacuum side with respect to Set Value 1 (P-1) and Set Value 3 (P-3), respectively.
- Auto-reference function acts on Set Value 3 (P-3) and Set Value 4 (P-4) only.
- Set Value 5 (P-5) is the auto-reference input value. If auto-reference input is not applied, Set Value 5 (P-5) is zero.
- The conditions which are set are stored in an EEPROM. Kindly note that the EEPROM has a life span and its guaranteed life is 100,000 write operation cycles. However, since the auto-reference input value [Set Value 5 (P-5)] is not written into the EEPROM, it is not included in the number of write operation cycles.

Setting procedure

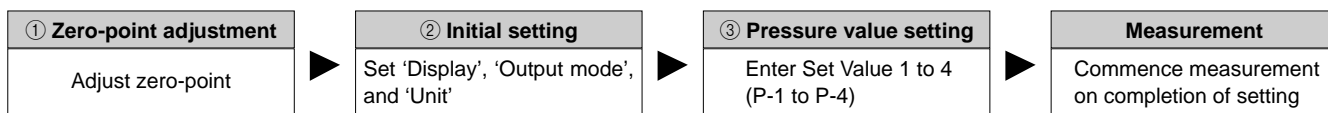

① Zero-point adjustment

- The displayed pressure when the pressure port is left open is adjusted to zero.

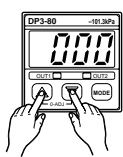

- The sensor will automatically enter the sensing mode when power is supplied.
- Let the pressure port be at atmospheric pressure (i.e., no applied pressure condition), and press, simultaneously, the increment and decrement keys continuously.
- 000 is displayed and, when the fingers are released, zero-point adjustment is completed and the sensor returns to the sensing mode.

② Initial setting

- Pressure 'Unit', 'Display' and 'Output mode' of the comparative outputs are set.



- In the sensing mode, press **MODE** key while pressing **▲** key.
 - Initial setting is displayed.
 - If sensor is being used for the first time, PHd is displayed.
- The settable digit blinks.
- The settable digit changes when **▲** key is pressed.
- The setting is changed when **▼** key is pressed.

Change with ▲ key

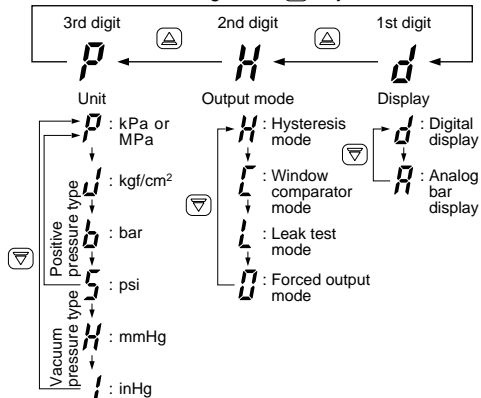

- If the output mode has been set to the window comparator mode (∫), set the pressure values so that there is a difference of 3 digits, or more, between Set Value 1 (P-1) and Set Value 2 (P-2), and between Set Value 3 (P-3) and Set Value 4 (P-4). Also, if the output mode has been set to the leak test mode (L), set the pressure values so that there is a difference of 3 digits, or more, between Set Value 3 (P-3) and Set Value 4 (P-4). However, when unit is set to 'psi' (5), the difference should be 6 digits, or more.

③ Pressure value setting

- Set Value 1 to 4 (P-1 to P-4) of the comparative outputs are set.
 - At each press of **MODE** key, the mode changes, in rotation, to Set Value 1 (P-1) set mode, Set Value 2 (P-2) set mode, Set Value 3 (P-3) set mode, Set Value 4 (P-4) set mode, Set Value 5 (P-5) display mode and sensing mode.

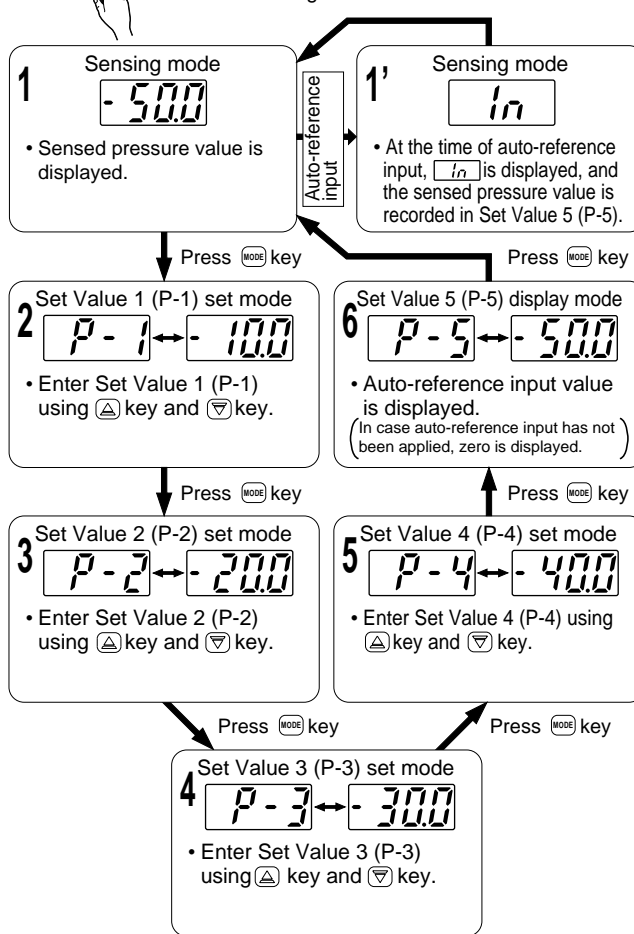

- The pressure values can be set only when the output mode has been set to hysteresis mode (H), window comparator mode (∫) or leak test mode (L). If the output mode has been set to the forced output mode (∩), pressure values cannot be set.

PRECAUTIONS FOR PROPER USE

All models

Auto-reference function

Principle

- Auto-reference function corrects Set Value 3 (P-3) and Set Value 4 (P-4) of Comparative Output 2 by taking the pressure measured at the time of auto-reference input as the reference pressure.

<Before auto-reference input>

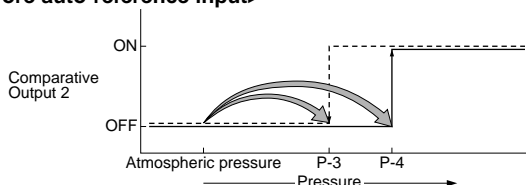

- When there is no auto-reference input, the atmospheric pressure is taken as the reference pressure for Set Value 3 (P-3) and Set Value 4 (P-4).

<After auto-reference input>

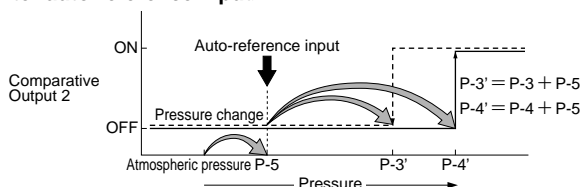

- At the time of auto-reference input, the pressure value detected at that instant is temporarily recorded as Set Value 5 (P-5) and becomes the reference pressure.
- With Set Value 5 (P-5) as the reference pressure, Set Value 3 (P-3) and Set Value 4 (P-4) are automatically corrected to 'Set Value 3 (P-3) + Set Value 5 (P-5)' and 'Set Value 4 (P-4) + Set Value 5 (P-5)', respectively.

Settable range and set pressure range after correction

- The settable range of Set Value 3 (P-3) and Set Value 4 (P-4) is wider than the rated pressure range to cater to the auto-reference function.

- At the time of auto-reference input, if the corrected set value exceeds the set pressure range, the set value is automatically corrected to be within the set pressure range. Hence, please see that the set pressure range is not exceeded.

	Settable range (P-3, P-4)											
	Set pressure range (P-3 and P-4 after correction)											
	Rated pressure range											
-101 kPa type	101.3	101.2	5.1	0	-0.1	-101.2	-101.3	UP	
100 kPa type	Lo	-100.0	-99.9	-5.0	0	0.1	99.9	100.0	UP
1 MPa type	-1.000	-0.999	-0.050	0	0.001	0.999	1.000		

Time chart

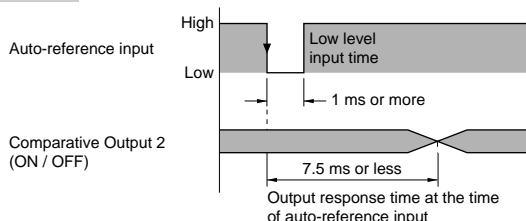

- Maintain the pressure at a constant level for at least 1 ms after the auto-reference input is made Low. If used in a transient state, it will result in wrong operation.
- Use Comparative Output 2 at least 7.5 ms after the auto-reference input is made low.
- At the time of auto-reference input, \overline{in} is displayed on the 3 1/2 digit LED display for 1 sec. approx., the pressure at that instant is stored temporarily in Set Value 5 (P-5), and Set Value 3 (P-3) and Set Value 4 (P-4) are corrected.
- Since Set Value 5 (P-5) and the corrected Set Value 3 (P-3') and Set Value 4 (P-4'), after the auto-reference input, are not stored in an EEPROM, they are erased when the power is switched off.

- When the power supply is switched on again, the auto-reference input value [Set Value 5 (P-5)] is set to zero.
- Although it is not possible to display the corrected Set Value 3 (P-3') and Set Value 4 (P-4'), it is possible to display the auto-reference input value [Set Value 5 (P-5)].
- In case the auto-reference input (pink) is not used, make sure to connect it to +V (brown).

Application examples

(1) Confirmation of PCB mount component suction (Using hysteresis mode)

- Pressure judgment errors due to suction nozzle type, suction nozzle clogging, reference pressure changes, etc., are eliminated by the auto-reference function.
- The confirmation of PCB mount component suction is done with Comparative Output 2, which is acted upon by the auto-reference function, and error due to nozzle clogging is simultaneously detected by Comparative Output 1.

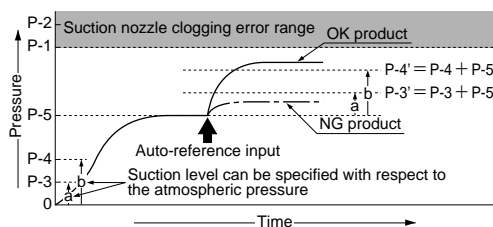

<Sensing method>

- By making the auto-reference input 'Low' when the PCB mount components are not being sucked, the reference pressure value is recorded in Set Value 5 (P-5), and Set Value 3 (P-3) and Set Value 4 (P-4) are corrected.
- Suction confirmation is done by Comparative Output 2, 7.5 ms, or more, after the application of the auto-reference input.
(If suction is OK, Comparative Output 2 is ON, and if it is NG, Comparative Output 2 is OFF.)
- Error due to suction nozzle clogging is detected by the setting of Comparative Output 1.
(If the nozzle is OK, Comparative Output 1 is OFF, and if it is NG, Comparative Output 1 is ON.)

(2) Air-leak test for PET bottles (Using leak test mode)

- The effect of dispersion in the filling pressure of the PET bottle is eliminated by using the auto-reference function.
- Comparative Output 1 is used to detect the filling pressure, while Comparative Output 2 is used to detect the leakage. Since Comparative Output 1 is not affected by the auto-reference input function, the filling pressure is detected with reference to the atmospheric pressure.

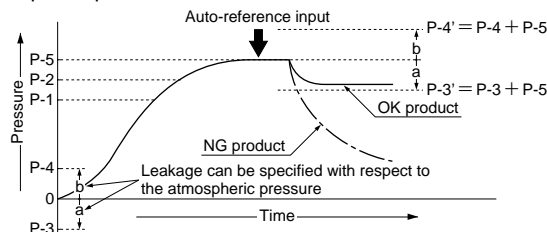

<Sensing method>

- Pressure is increased in the PET bottle, and when Set Value 2 (P-2) is reached, Comparative Output 1 is turned ON and the filling is tightly shut off.
- After shutting off the filling pressure, the auto-reference input is made 'Low'. The filled pressure is recorded in Set Value 5 (P-5) as the reference value, and Set Value 3 (P-3) and Set Value 4 (P-4) are corrected.
- The leakage is measured by Comparative Output 2, 7.5 ms, or more, after the application of the auto-reference input.
(If the leakage is OK, Comparative Output 2 is ON, and if it is NG, Comparative Output 2 is OFF.)

If it is a simple air-leak test, it can be done by directly applying the Comparative Output 1 signal (falling signal) to the auto-reference input.

PRECAUTIONS FOR PROPER USE

All models

Peak hold & bottom hold functions

- Peak hold and bottom hold functions enable the display of the peak value (maximum pressure value in case of the positive pressure type sensor and maximum vacuum pressure value in case of the vacuum pressure type sensor) and the bottom value (minimum pressure value in case of the positive pressure type sensor and minimum vacuum pressure value in case of the vacuum pressure type sensor) of the varying measured pressure. These functions are convenient for finding the pressure variation range or for determining the reference for pressure settings.

- Please note that the peak value and the bottom value data is erased when it is no longer displayed.
- The response time of the comparative outputs becomes slower during the peak hold and bottom hold display.

Peak hold display

Initiating peak hold display



- In the sensing mode, keep Δ key pressed until PUP is displayed. (4 sec. approx.)
- When the finger is released after PUP is displayed, the peak value and PUP are displayed alternately.

Displayed alternately



- If the applied pressure exceeds the displayable pressure range, error message (--- or ---) and PUP are displayed alternately. In this case, bring back the applied pressure to within the rated pressure range.
- The figure on the left shows the display of a vacuum type sensor when the pressure unit has been set to 'kPa' (P).

Ending peak hold display



- Press Δ key. [Sensor returns to sensing mode.]

Bottom hold display

Initiating bottom hold display

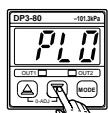

- In the sensing mode, keep ∇ key pressed until PLB is displayed. (4 sec. approx.)
- When the finger is released after PLB is displayed, the bottom value and PLB are displayed alternately.

Displayed alternately



- If the applied pressure exceeds the displayable pressure range, error message (--- or ---) and PLB are displayed alternately. In this case, bring back the applied pressure to within the rated pressure range.
- The figure on the left shows the display of a vacuum type sensor when the pressure unit has been set to 'kPa' (P).

Ending bottom hold display



- Press ∇ key. [Sensor returns to sensing mode.]

Forced output mode

- In the initial setting, if the output mode is set to the forced output mode (∇), Comparative Output 1, 2 are forcibly maintained at OFF level in the sensing mode, irrespective of Set Value 1 to 4 (P-1 to P-4). Hence, this mode is useful when it is desired to only display the pressure value without using the comparative outputs.

Further, if the keys are operated as per the procedure given below, Comparative Output 1, 2 can be forcibly switched either ON or OFF without applying pressure at the pressure port. This is convenient for an operation check of Comparative Output 1, 2 or for an inspection before commencing work.

(The figure below is for a vacuum pressure type sensor with the unit set to 'kPa' (P)).

Sensing mode

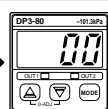

Press MODE key

Forced output mode

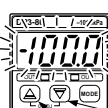

Blinking display of measured pressure

Each time ∇ key is pressed, Comparative Output 2 switches between ON and OFF. (Operation indicator also lights up, turns off.)

Each time Δ key is pressed, Comparative Output 1 switches between ON and OFF. (Operation indicator also lights up, turns off.)

Press MODE key

[Sensor returns to sensing mode.]

Time chart

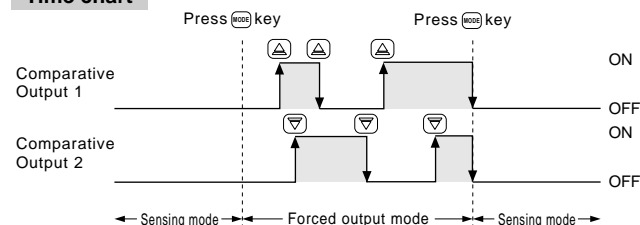

- The comparative outputs are held at the OFF level from the time a change is made to the forced output mode (∇) from the other modes.
- Even if a comparative output is held at the ON level in the forced output mode, it is forcibly brought to the OFF level at the time the sensor returns to the sensing mode.

Key-protect function

- Key-protect is a function which prevents any unintentional change in the conditions which have been entered in each setting mode by making the sensor not to respond to the key operations.

Setting of key-protect

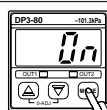

- In the sensing mode, press MODE key continuously for about 3 sec. and release it immediately when On is displayed.
- Key-protect is set and the sensor returns to the sensing mode.

Release of key-protect

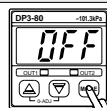

- In the sensing mode, press MODE key continuously for about 3 sec. and release it immediately when OFF is displayed.
- Key-protect is released and the sensor returns to the sensing mode.

DP3

PRECAUTIONS FOR PROPER USE

Standard type

Setting of pressure lead direction

- The pressure lead direction can be changed by dismantling the pressure port attachment and changing the mounting direction. The tightening torque of the hexagon-socket-head bolt (length: 9 mm 0.354 in or less) should be 0.29 N·m or less.

Note: Make sure to close any unused pressure port with the hexagon-socket-head plug supplied as accessory.

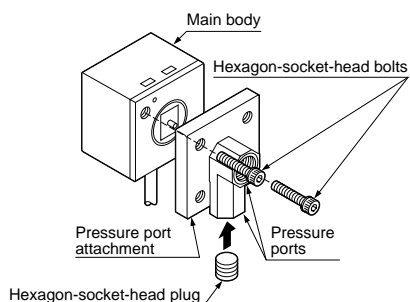

Piping

- When connecting a hexagon-socket-head plug or coupling to the pressure port, hold the hexagonal part of the pressure port with a 12 mm 0.472 in spanner and make sure that the tightening torque is 9.8 N·m or less. Also, in order to prevent any leakage, wind a sealing tape on the coupling when connecting.

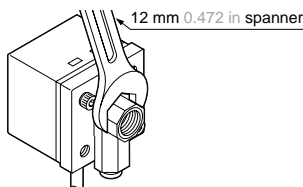

Mounting

- When mounting the sensor with the sensor mounting bracket, etc., the tightening torque should be 1.2 N·m or less.

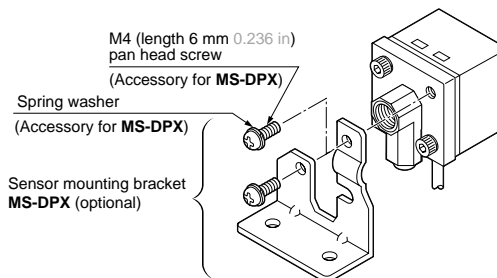

Flat type Light weight type

Setting of pressure lead direction

- The pressure lead direction can be changed by dismantling the pressure port attachment and changing the mounting direction. The tightening torque of the hexagon-socket-head bolt (length: 9 mm 0.354 in or less) should be 0.29 N·m or less.

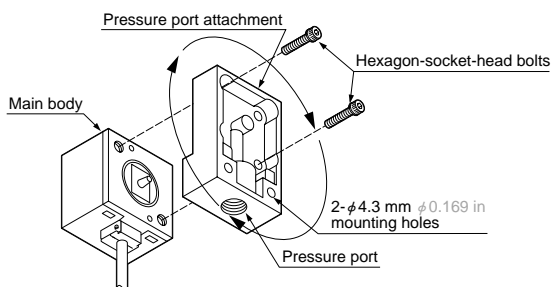

Piping

- When connecting a coupling to the pressure port, hold the pressure port attachment with a 16 mm 0.630 in (light weight type: 10 mm 0.394 in) spanner and make sure that the tightening torque is 9.8 N·m or less (light weight type: 1.47 N·m or less). Also, in order to prevent any leakage, wind a sealing tape on the coupling when connecting.

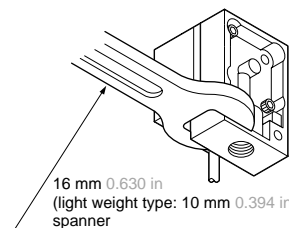

DIMENSIONS (Unit: mm in) The CAD data in the dimensions can be downloaded from the SUNX website: <http://www.sunx.co.jp/>

DP3-20 DP3-21 DP3-22 Standard type

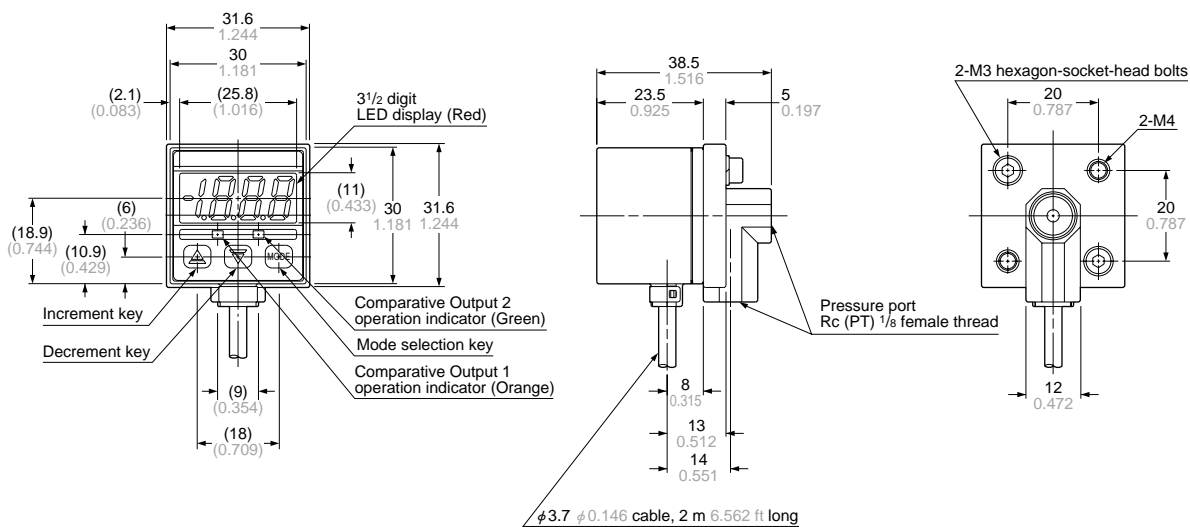

DP3-80 Light weight type

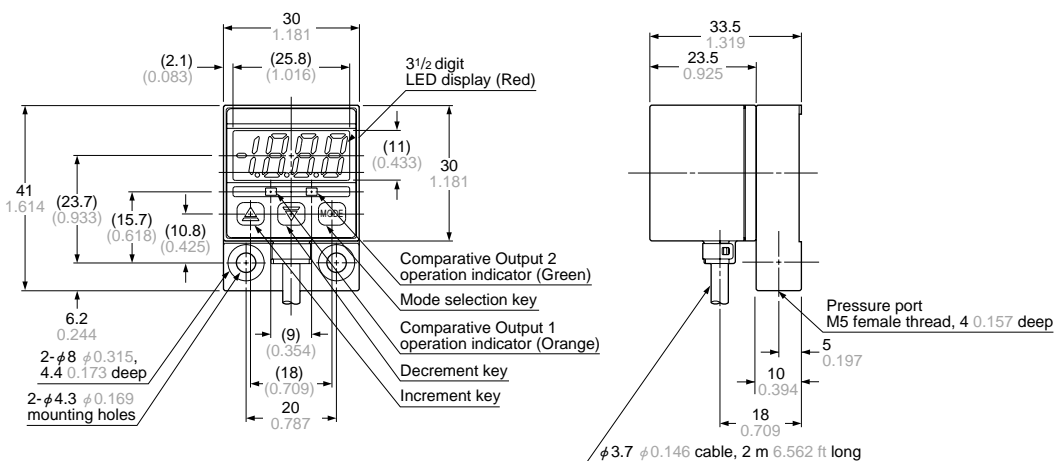

DP3-41 DP3-42 Flat type

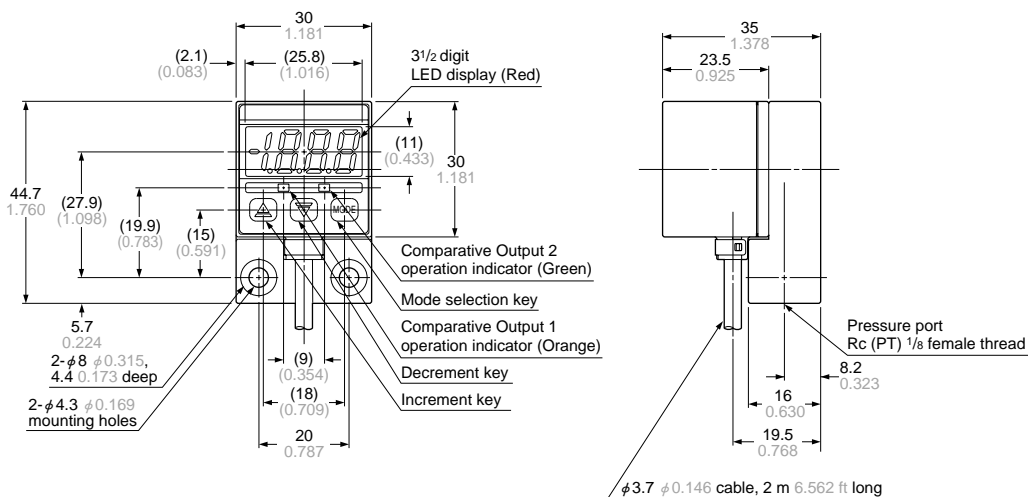

Head-separated

DP5/DPH

Digital Display

DP4

DP2

DP3

LED Bar Display

DP-M

PE

DIMENSIONS (Unit: mm in) The CAD data in the dimensions can be downloaded from the SUNX website: <http://www.sunx.co.jp/>

MS-DPX Sensor mounting bracket for standard type (Optional)

Assembly dimensions

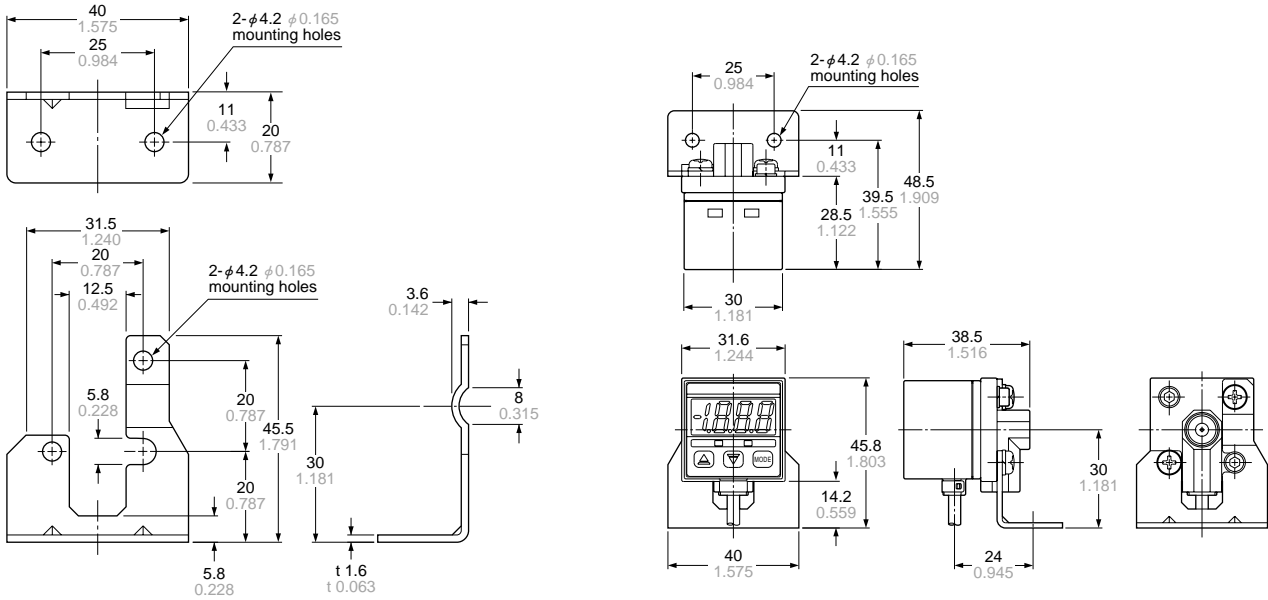

Material: Cold rolled carbon steel (SPCC)
(Uni-chrome plated)

Two M4 (length 6 mm 0.236 in) pan head screws
and two spring washers are attached.

MS-DPX-4 Back angled mounting bracket for standard type (Optional)

Assembly dimensions

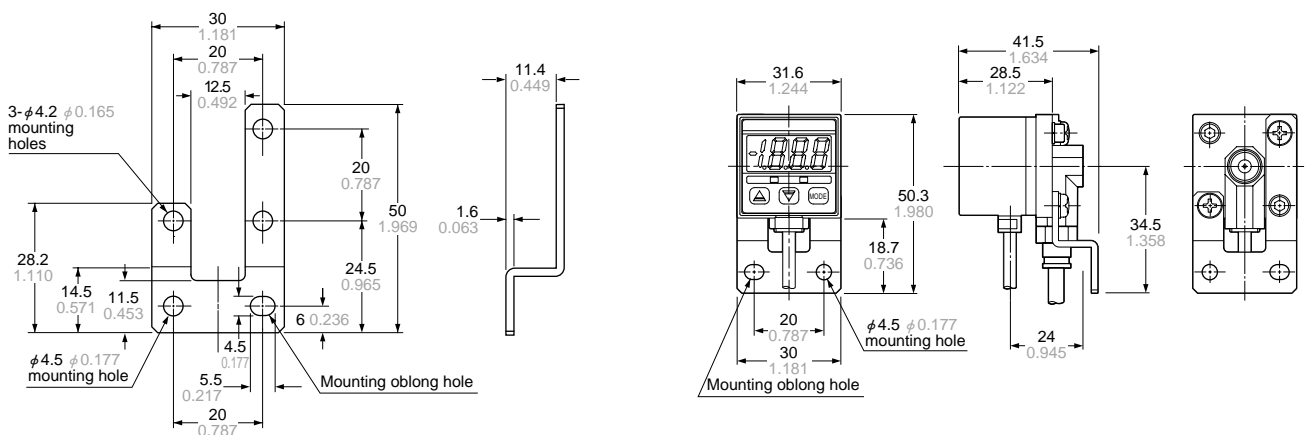

Material: Cold rolled carbon steel (SPCC)
(Uni-chrome plated)

Two M4 (length 6 mm 0.236 in) pan head screws
and two spring washers are attached.

DIMENSIONS (Unit: mm in) The CAD data in the dimensions can be downloaded from the SUNX website: <http://www.sunx.co.jp/>

**MS-DPX-2
DPX-04**

Panel mounting bracket, front protection cover for standard type (Optional)

Assembly dimensions

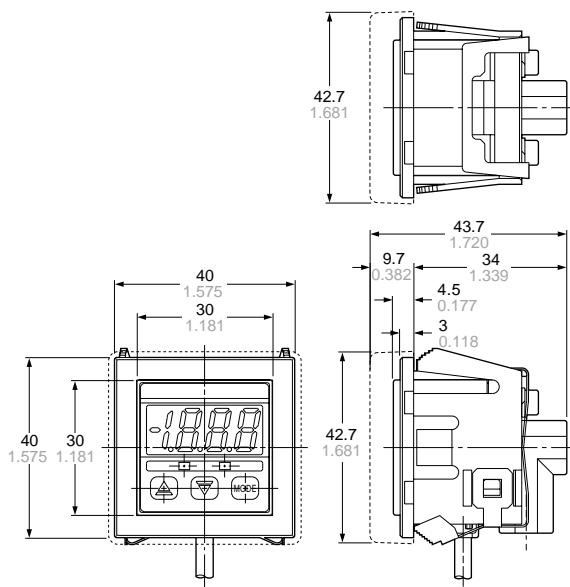

portion shows the front protection cover.

Material: Polycarbonate (Front protection cover)
Nylon 6, Stainless steel (SUS304)(Panel mounting bracket)

Panel cut-out dimensions

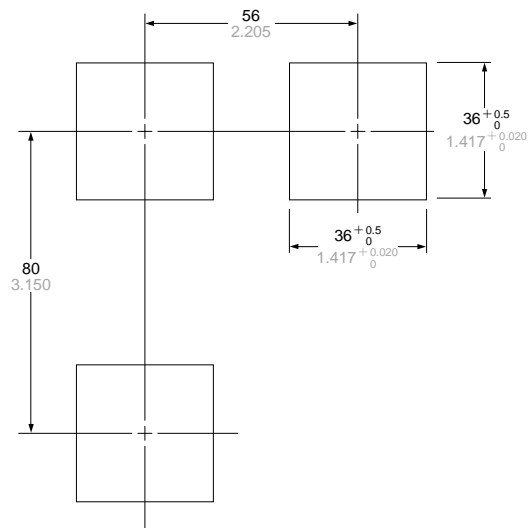

Note: The panel thickness should be 1 to 3.2 mm 0.039 to 0.126 in.