

阅读申明

- 1.本站收集的数据手册和产品资料都来自互联网，版权归原作者所有。如读者和版权方有任何异议请及时告之，我们将妥善解决。
- 2.本站提供的中文数据手册是英文数据手册的中文翻译，其目的是协助用户阅读，该译文无法自动跟随原稿更新，同时也可能存在翻译上的不当。建议读者以英文原稿为参考以便获得更精准的信息。
- 3.本站提供的产品资料，来自厂商的技术支持或者使用者的心得体会等，其内容可能存在描述上的差异，建议读者做出适当判断。
- 4.如需与我们联系，请发邮件到marketing@iczoom.com，主题请标有“数据手册”字样。

Read Statement

1. The datasheets and other product information on the site are all from network reference or other public materials, and the copyright belongs to the original author and original published source. If readers and copyright owners have any objections, please contact us and we will deal with it in a timely manner.
2. The Chinese datasheets provided on the website is a Chinese translation of the English datasheets. Its purpose is for reader's learning exchange only and do not involve commercial purposes. The translation cannot be automatically updated with the original manuscript, and there may also be improper translations. Readers are advised to use the English manuscript as a reference for more accurate information.
3. All product information provided on the website refer to solutions from manufacturers' technical support or users the contents may have differences in description, and readers are advised to take the original article as the standard.
4. If you have any questions, please contact us at marketing@iczoom.com and mark the subject with "Datasheets" .



Sensing distance			Supply voltage	Output
20 mm		5 mm	12 to 24 VDC	 100/200 mA NPN or PNP
		1.5mm		
		3 mm 5 mm		

Inductive Proximity Sensor

TL-W/WM

Space Saving Flat Proximity Switch

- Space-saving, low-profile rigid aluminum die-cast housing (TL-W5E/F).
- All models provided with an operation indicator.
- Mounting possible from either the front or rear of the housing.
- Protected to endure water and oil splashes (conforms to IEC IP67).
- DC 2-wire models (TL-W5MD1/-W5MD2) provide easy wiring.

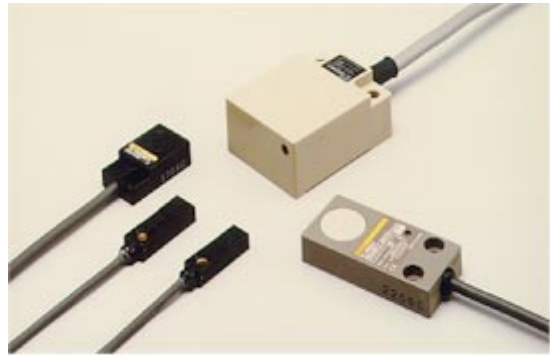

Ordering Information

DC 2-wire

Sensing head	Sensing distance	Output			
		NPN		PNP	
		NO	NC	NO	NC
Non-shielded	5 mm	TL-W5MD1	TL-W5MD2	---	---

DC 3-wire

Sensing head	Sensing distance	Output			
		NPN		PNP	
		NO	NC	NO	NC
Shielded	5 mm	TL-W5E1	TL-W5E2	TL-W5F1	TL-W5F2
Non-shielded	1.5 mm	TL-W1R5MC1	---	TL-W1R5MB1	---
	3 mm	TL-W3MC1	TL-W3MC2	TL-W3MB1	TL-W3MB2
	5 mm	TL-W5MC1	TL-W5MC2	TL-W5MB1	---
	20 mm	TL-W20ME1	TL-W20ME2	---	---

Application Examples

Position of Workpiece

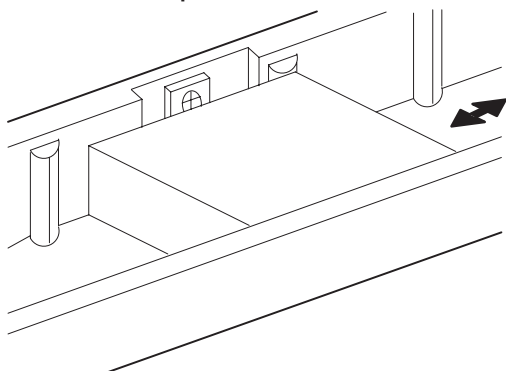

Specifications

■ Ratings/Characteristics

DC 2-wire

Item	TL-W5MD	
Sensing distance	5 mm \pm 10%	
Supply voltage (operating voltage range)	12 to 24 VDC (10 to 30 VDC)	
Current consumption (leakage current)	0.8 mA max.	
Sensing object	Magnetic metals (refer to "Engineering Data" for non-magnetic metals)	
Setting distance (standard sensing object)	0 to 4 mm (iron, 18 x 18 x 1 mm)	
Differential travel	10% max. of sensing distance	
Response frequency (see note)	0.5 kHz	
Operating mode (for detecting sensing objects)	D1 models: Load ON D2 models: Load OFF	
Control output (switching capacity)	3 to 100 mA DC	
Circuit protection	Load short-circuit protection	
Indicator	D1 models: Operation indicator (red LED), operation set indicator (green LED) D2 models: Operation indicator (red LED)	
Ambient temperature	Operating: -25°C to 70°C (with no icing)	
Ambient humidity	Operating: 35% to 95%	
Temperature influence	\pm 10% max. of sensing distance at 23°C in temperature range of -25°C to 70°C	
Voltage influence	\pm 2.5% max. of sensing distance in rated voltage range \pm 15%	
Residual voltage	3.3 V max. (with 100 mA load current and 2-m cable)	
Insulation resistance	50 M Ω min. (at 500 VDC) between current carry parts and case	
Dielectric strength	1,000 VAC for 1 min between current carry parts and case	
Vibration resistance	Destruction: 10 to 55 Hz, 1.5-mm double amplitude for 2 hrs each in X, Y, and Z directions	
Shock resistance	Destruction: 500 m/s ² (approx. 50G) for 3 times each in X, Y, and Z directions	
Enclosure ratings	IEC IP67 (JEM IP67G (water-tight, oil-tight))	
Weight (with 2-m cable)	Approx. 45 g	
Material	Case	Heat-resistive ABS resin
	Sensing surface	

Note: The response frequency in the table is a mean value obtained under the following conditions.
 Location of each standard sensing object: At a distance half as long as the sensing distance of the sensor.
 Distance between any two adjacent standard sensing objects: Twice as wide as the width of the standard sensing object.

DC 3-wire

Item	TL-W1R5M	TL-W3M	TL-W5M	TL-W5	TL-W20M
Sensing distance	1.5 mm ±10%	3 mm ±10%	5 mm ±10%		20 mm ±10%
Supply voltage (operating voltage range)	12 to 24 VDC (10 to 30 VDC), ripple (p-p): 10% max.			12 to 24 VDC (10 to 30 VDC), ripple (p-p): 20% max.	12 to 24 VDC (10 to 30 VDC)
Current consumption (leakage current)	15 mA max. at 24 VDC (no-load)		10 mA max.	15 mA max. at 24 VDC (no-load)	8 mA at 12 VDC, 15 mA at 24 VDC
Sensing object	Magnetic metals (Non-magnetic metals can be detected if they are located close to the sensor. Refer to "Engineering Data" for details)				
Setting distance (standard sensing object)	0 to 1.2 mm (iron, 8 x 8 x 1 mm)	0 to 2.4 mm (iron, 12 x 12 x 1 mm)	0 to 4 mm (iron, 18 x 18 x 1 mm)		0 to 16 mm (iron, 50 x 50 x 1 mm)
Differential travel	10% max. of sensing distance				1% to 15% of sensing distance
Response frequency (see note)	1 kHz	600 Hz min.	500 Hz min.	300 Hz min.	40 Hz
Operating mode (for detecting sensing objects)	Load ON			E1 models: Output signal low, load ON E2 models: Output signal high, load OFF F1 models: Output signal high, load ON F2 models: Output signal low, load OFF	
Control output (switching capacity)	NPN or PNP open collector, 100 mA max.		NPN or PNP open collector, 50 mA max. at 12 VDC, 100 mA max. at 24 VDC	200 mA max.	100 mA max. at 12 VDC, 200 mA max. at 24 VDC
Circuit protection	Reverse connection protection				---
Ambient temperature	Operating: -25°C to 70°C (with no icing)				
Ambient humidity	Operating: 35% to 95%				
Temperature influence	±10% max. of sensing distance at 23°C in temperature range of -25°C to 70°C				
Voltage influence	±2.5% max. of sensing distance in rated voltage range ±10%		±2.5% max. of sensing distance in rated voltage range ±20%	±2.5% max. of sensing distance in rated voltage range ±10%	
Residual voltage	1.0 V max. (with 100 mA load current and 2-m cable)		1.0 V max. (with 50 mA load current and 2-m cable)	2.0 V max. (with 200 mA load current and 2-m cable)	1.0 V max. (with 200 mA load current and 2-m cable)
Insulation resistance	50 MΩ min. (at 500 VDC) between current carry parts and case				
Dielectric strength	1,000 VAC, 50/60 Hz for 1 min between current carry parts and case				
Vibration resistance	Destruction: 10 to 55 Hz, 1.5-mm double amplitude for 2 hrs each in X, Y, and Z directions				
Shock resistance	Destruction: 500 m/s ² (approx. 50G) for 3 times each in X, Y, and Z directions				Destruction: 500 m/s ² (approx. 50G) for 10 times each in X, Y, and Z directions
Enclosure ratings	IEC IP67 (JEM IP67G (water-tight, oil-tight))				
Weight (with 2-m cable)	Approx. 30 g		Approx. 45 g	Approx. 70 g	Approx. 180 g
Material	Case	ABS resin		ADC (Al die-cast)	Heat-resistive ABS
	Sensing surface	ABS resin			

Engineering Data

Operating Range (Typical)

TL-W1R5M

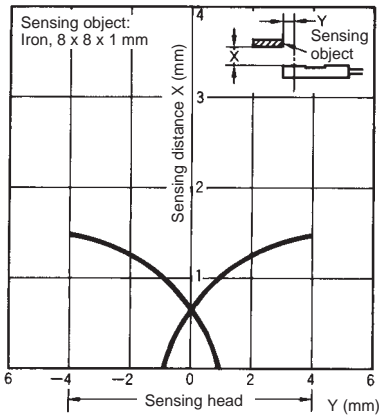

TL-W3M

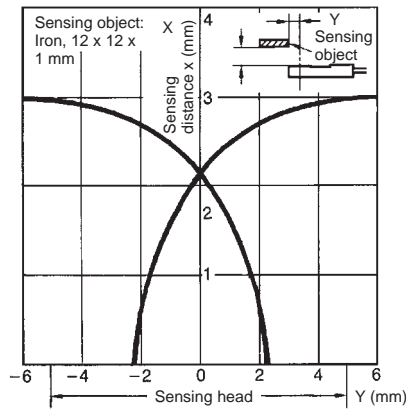

TL-W5M

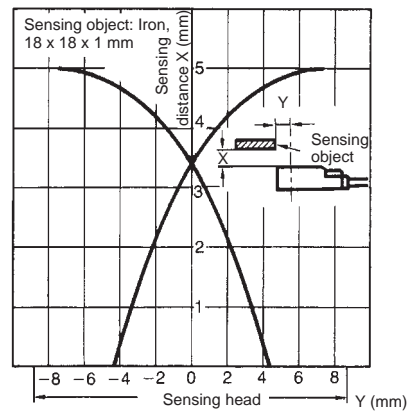

TL-W5

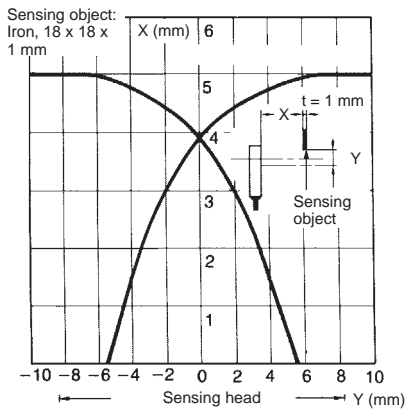

TL-W20M

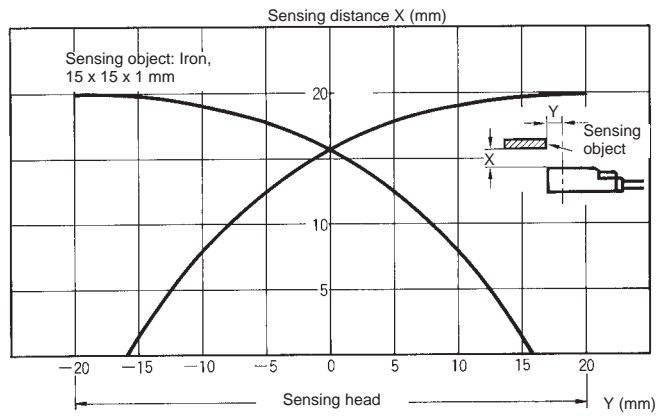

Sensing Distance vs. Size and Material of Sensing Object (Typical)

TL-W1R5M

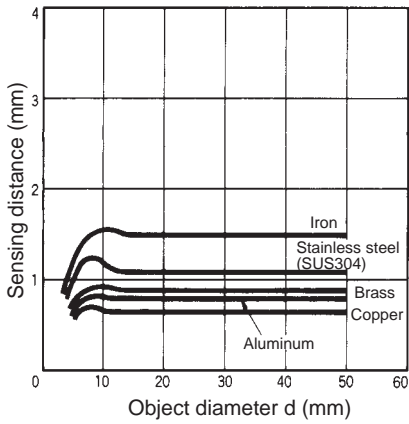

TL-W3M

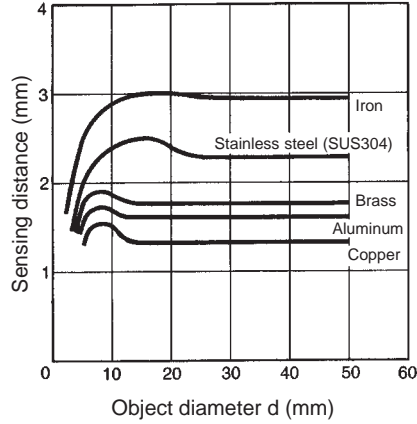

TL-W5M

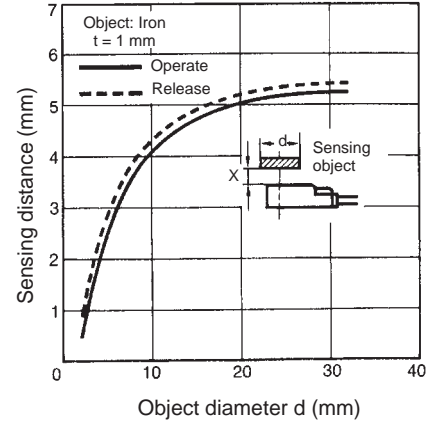

TL-W5

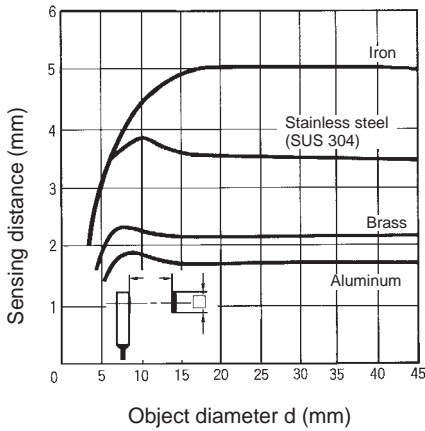

TL-W20M

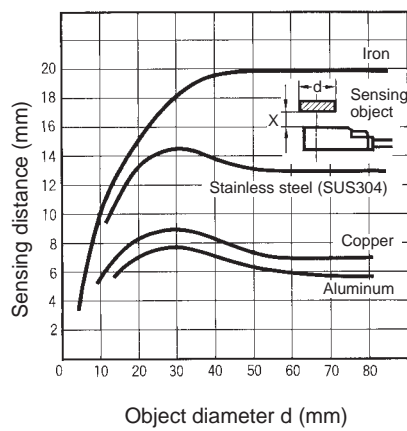

Operation

■ Output Circuits

DC 2-wire

TL-W5MD□

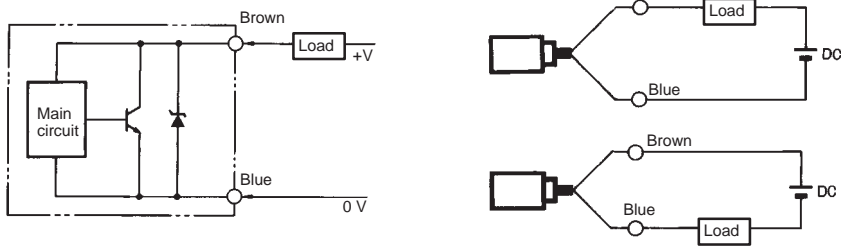

Note: The load can be connected as shown in the above diagram.

DC 3-wire

TL-W1R5MC1
TL-W3MC□
TL-W5MC□

TL-W5E□
TL-W20ME□

TL-W5F□

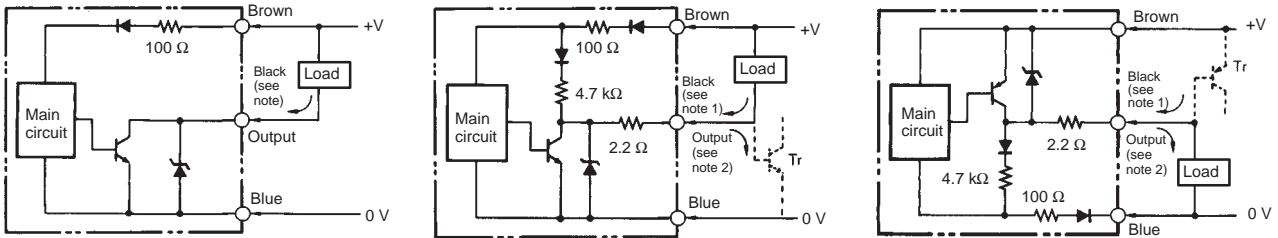

Note: Maximum load current: 100 mA

Note: 1. Maximum load current: 200 mA
2. Current flows in this direction if the circuit incorporates the transistor.

TL-W1R5MB1
TL-W3MB□
TL-W5MB1

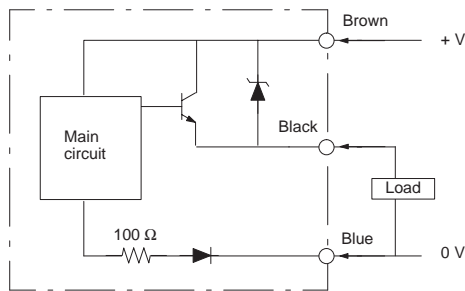

■ Timing Chart

DC 2-wire

NO Model

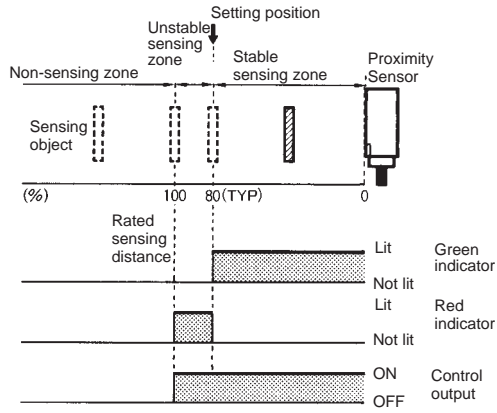

NC Model

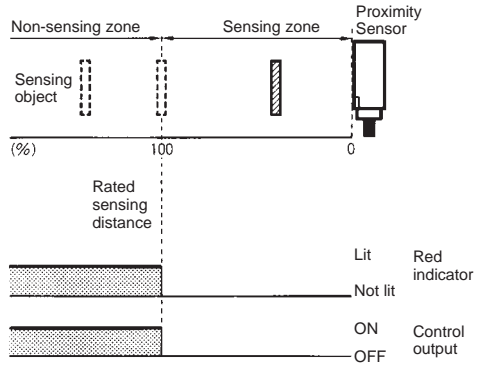

DC 3-wire

- TL-W1R5M□1
- TL-W3M□
- TL-W5M□

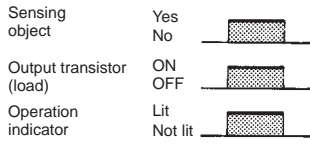

- TL-W5□
- TL-W20ME□

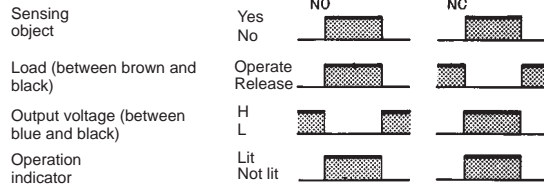

TL-W5F□

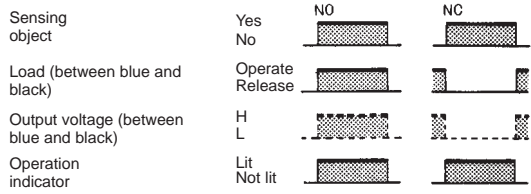

Dimensions

Note: All units are in millimeters unless otherwise indicated.

TL-W1R5M□1

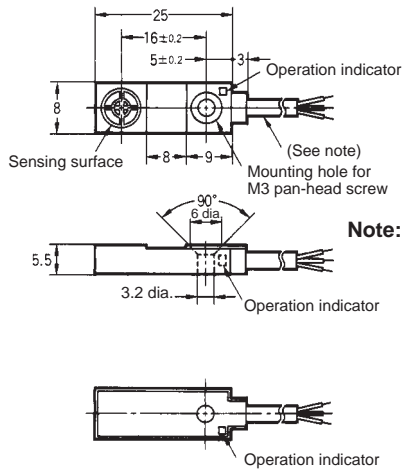
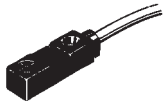

Note: Round vinyl-insulated cable (2.9 dia., 0.12 dia. x 12, 3 cores)
Standard length: 2 m (oil-tight)

Mounting Bracket (Attachment)

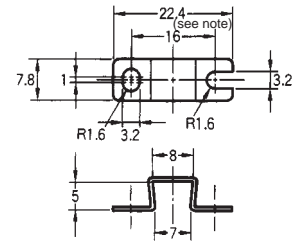

Note: Mounting dimensions: 17 ± 0.2

TL-W3M□□

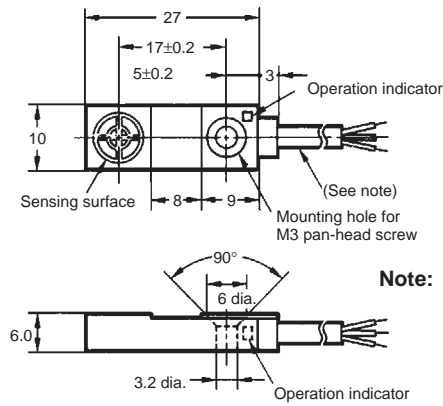
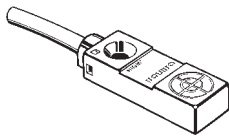

Note: Round vinyl-insulated cable (2.9 dia., 0.12 dia. x 12, 3 cores)
Standard length: 2 m (oil-tight)

Mounting Bracket (Attachment)

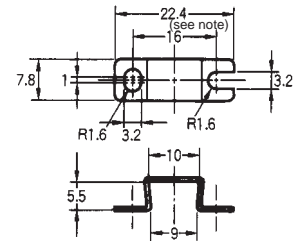

Note: Mounting dimensions: 17 ± 0.2

TL-W5M□□

TL-W5MD□□

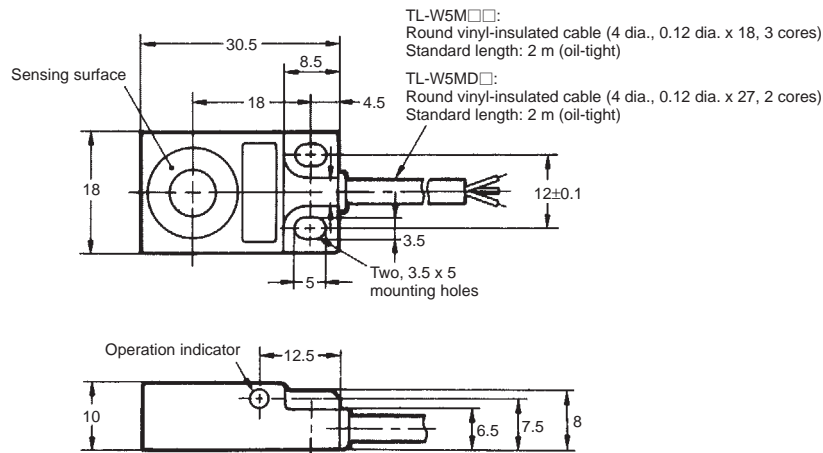
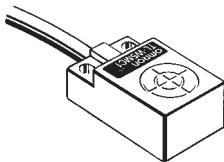

TL-W5E□
TL-W5F□

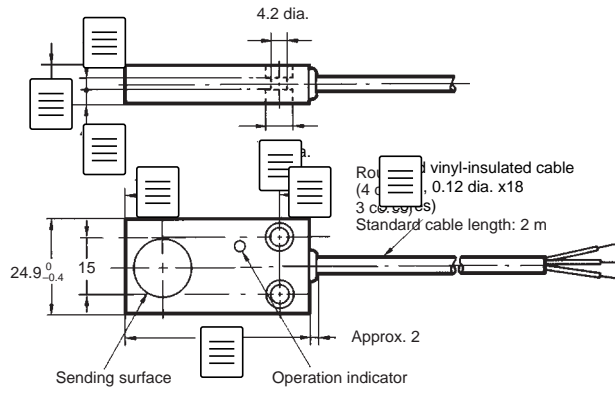
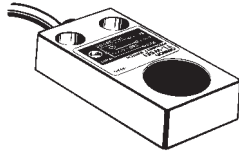

Mounting Holes

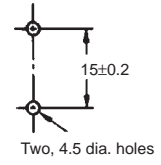

TL-W20ME□

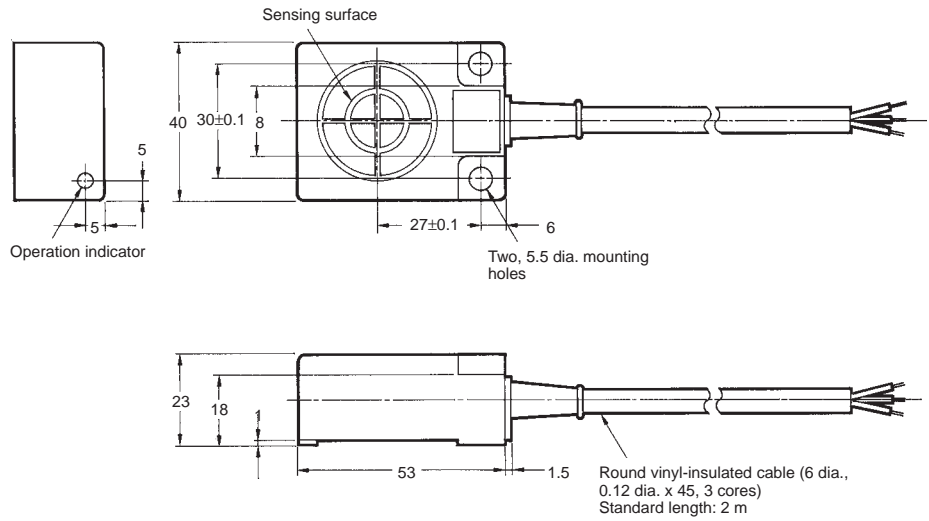
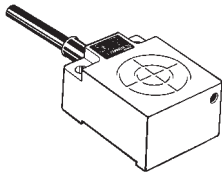

Precautions

Effects of Surrounding Metals

Provide a minimum distance as shown in the table below between the TL-W and the surrounding metals to prevent the TL-W from being induced by the metals and malfunctioning or being affected by the heat radiated by the metals.

Model	ℓ	m	n
TL-W1R5M□1	2 mm	0 mm	8 mm
TL-W3M	3 mm	0 mm	12 mm
TL-W5MD	5 mm	0 mm	20 mm
TL-W5MC/MB	5 mm	0 mm	20 mm
TL-W20ME	25 mm	16 mm	100 mm
TL-W5E/F	0 mm	0 mm	20 mm

Metal on a Single Side
(not exceeding the height of the sensor head)

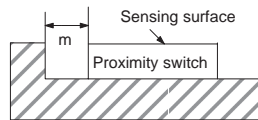

Metals on Both Sides and in front of the Sensor

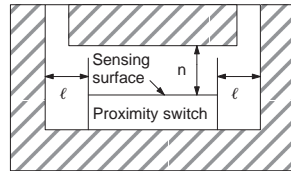

Mutual Interference

Be sure to space the two sensors at a distance greater than that shown in the table to prevent mutual interference.

Model	A	B
TL-W1R5M□1	75 (50) mm	25 (8) mm
TL-W3M	90 (60) mm	30 (10) mm
TL-W5MD	120 (80) mm	60 (30) mm
TL-W5MC/MB	120 (80) mm	60 (30) mm
TL-W20ME	200 (100) mm	200 (100) mm
TL-W5E/F	50 mm	35 mm

Note: The above values in parentheses are applicable when using two sensors with different frequencies.

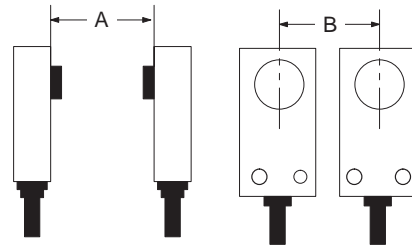

Mounting

Use M3 flat-head screws to mount the TL-W1R5M□1 and TL-W3M□1.

The resin cover should be tightened to 10 kgf • cm (0.98 N • m) maximum.

ALL DIMENSIONS SHOWN ARE IN MILLIMETERS.

To convert millimeters into inches, multiply by 0.03937. To convert grams into ounces, multiply by 0.03527.

Cat. No. E221-E1-2 **In the interest of product improvement, specifications are subject to change without notice.**

OMRON Corporation

Systems Components Division H.Q.
28th Fl., Crystal Tower Bldg.
1-2-27, Shiromi, Chuo-ku,
Osaka 540 Japan
Phone: 06-949-6012 Fax: 06-949-6021

Printed in Japan
0196-1.5M (1291) a

