

阅读申明

- 1.本站收集的数据手册和产品资料都来自互联网，版权归原作者所有。如读者和版权方有任何异议请及时告之，我们将妥善解决。
- 2.本站提供的中文数据手册是英文数据手册的中文翻译，其目的是协助用户阅读，该译文无法自动跟随原稿更新，同时也可能存在翻译上的不当。建议读者以英文原稿为参考以便获得更精准的信息。
- 3.本站提供的产品资料，来自厂商的技术支持或者使用者的心得体会等，其内容可能存在描述上的差异，建议读者做出适当判断。
- 4.如需与我们联系，请发邮件到marketing@iczoom.com，主题请标有“数据手册”字样。

Read Statement

1. The datasheets and other product information on the site are all from network reference or other public materials, and the copyright belongs to the original author and original published source. If readers and copyright owners have any objections, please contact us and we will deal with it in a timely manner.
2. The Chinese datasheets provided on the website is a Chinese translation of the English datasheets. Its purpose is for reader's learning exchange only and do not involve commercial purposes. The translation cannot be automatically updated with the original manuscript, and there may also be improper translations. Readers are advised to use the English manuscript as a reference for more accurate information.
3. All product information provided on the website refer to solutions from manufacturers' technical support or users the contents may have differences in description, and readers are advised to take the original article as the standard.
4. If you have any questions, please contact us at marketing@iczoom.com and mark the subject with "Datasheets" .

GX-N SERIES

DC 3-wire Cylindrical Inductive Proximity Sensor **Amplifier Built-in**

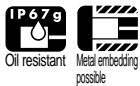

High performance and environmental resistance at low price

Robust in tightening

The tightening torque has been improved to approx. four times greater than that of conventional models because of its thick case. As the sensor can be securely tightened, it does not get loose due to vibration or shock.

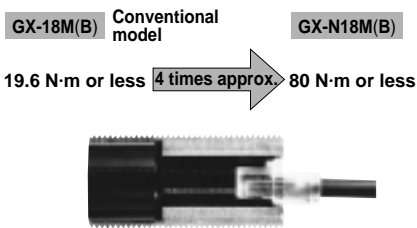

Long sensing range

The **GX-N** series features 1.6 times longer sensing range than conventional models. Setting with enough margin is possible.

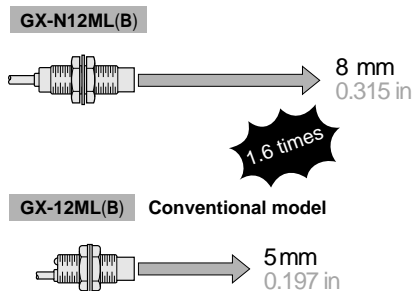

Cost effective

It combines high reliability with cost effectiveness.

Visible operation indicator

The operation indicator (orange) is easily observable from any direction since it is housed in the transparent tail section, which lights up brightly.

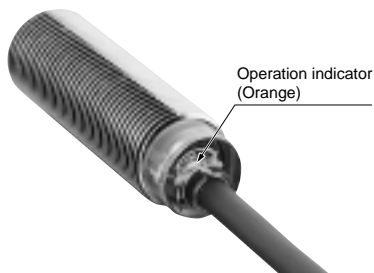

APPLICATIONS

Detecting traveling aluminum pallets

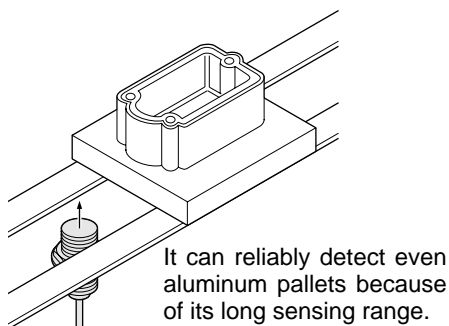

Controlling depth of drilling

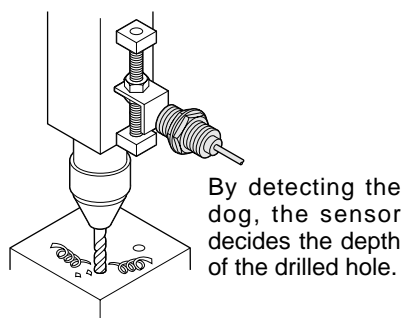

Detecting workpiece in robot hand

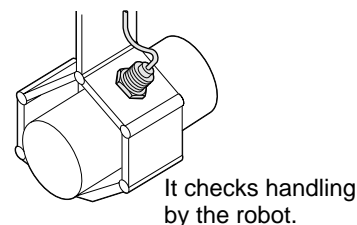

ORDER GUIDE

Type	Appearance (mm in)	Sensing range (Note)	Model No.	Output	Output operation
Shielded type			GX-N12M	NPN open-collector transistor	Normally open
			GX-N12MB		Normally closed
			GX-N18M		Normally open
			GX-N18MB		Normally closed
			GX-N30M		Normally open
			GX-N30MB		Normally closed
Non-shielded type			GX-N12ML	NPN open-collector transistor	Normally open
			GX-N12MLB		Normally closed
			GX-N18ML		Normally open
			GX-N18MLB		Normally closed
			GX-N30ML		Normally open
			GX-N30MLB		Normally closed

Note: The maximum operation distance stands for the maximum distance for which the sensor can detect the standard sensing object.
 The stable sensing range stands for the sensing range for which the sensor can stably detect the standard sensing object even if there is an ambient temperature drift and/or supply voltage fluctuation.

GX-N

ORDER GUIDE

5 m 16.404 ft cable length type

5 m 16.404 ft cable length type (standard: 2 m 6.562 ft) is also available.

• Table of Model Nos.

Type	Standard	5 m 16.404 ft cable length type
Shielded type	GX-N12M	GX-N12M-C5
	GX-N12MB	GX-N12MB-C5
	GX-N18M	GX-N18M-C5
	GX-N18MB	GX-N18MB-C5
	GX-N30M	GX-N30M-C5
	GX-N30MB	GX-N30MB-C5
Non-shielded type	GX-N12ML	GX-N12ML-C5
	GX-N12MLB	GX-N12MLB-C5
	GX-N18ML	GX-N18ML-C5
	GX-N18MLB	GX-N18MLB-C5
	GX-N30ML	GX-N30ML-C5
	GX-N30MLB	GX-N30MLB-C5

OPTIONS

Designation	Model No.	Description	
Protection cover	MS-H12	For GX-N12M(B)	It protects the sensing surface from welding sparks (spatter), etc.
	MS-H18	For GX-N18M(B)	
	MS-H30	For GX-N30M(B)	

Protection cover

- MS-H12
- MS-H18
- MS-H30

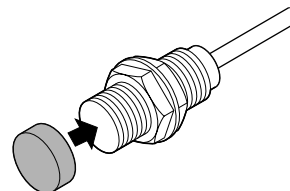

SPECIFICATIONS

Item	Type	Shielded type						Non-shielded type					
	Model No.	GX-N12M	GX-N12MB	GX-N18M	GX-N18MB	GX-N30M	GX-N30MB	GX-N12ML	GX-N12MLB	GX-N18ML	GX-N18MLB	GX-N30ML	GX-N30MLB
Max. operation distance (Note 1)		3 mm 0.118 in ± 10 %		7 mm 0.276 in ± 10 %		10 mm 0.394 in ± 10 %		8 mm 0.315 in ± 10 %		15 mm 0.591 in ± 10 %		22 mm 0.866 in ± 10 %	
Stable sensing range (Note 1)		0 to 2.4 mm 0 to 0.094 in		0 to 5.6 mm 0 to 0.220 in		0 to 8 mm 0 to 0.315 in		0 to 6.4 mm 0 to 0.252 in		0 to 12 mm 0 to 0.472 in		0 to 17.6 mm 0 to 0.693 in	
Standard sensing object		Iron sheet 12 X 12 X t 1 mm 0.472 X 0.472 X t 0.039 in		Iron sheet 18 X 18 X t 1 mm 0.709 X 0.709 X t 0.039 in		Iron sheet 30 X 30 X t 1 mm 1.181 X 1.181 X t 0.039 in		Iron sheet 30 X 30 X t 1 mm 1.181 X 1.181 X t 0.039 in		Iron sheet 50 X 50 X t 1 mm 1.969 X 1.969 X t 0.039 in		Iron sheet 70 X 70 X t 1 mm 2.756 X 2.756 X t 0.039 in	
Hysteresis		20 % or less of operation distance											
Supply voltage		12 to 24 V DC ±10% Ripple P-P 10 % or less											
Current consumption		10 mA or less											
Output		NPN open-collector transistor • Maximum sink current: 100 mA • Applied voltage: 30 V DC or less (between output and 0 V) • Residual voltage: 1.5 V or less (at 100 mA sink current) 0.4 V or less (at 16 mA sink current)											
	Output operation	Normally open	Normally closed	Normally open	Normally closed	Normally open	Normally closed	Normally open	Normally closed	Normally open	Normally closed	Normally open	Normally closed
	Short-circuit protection	Incorporated											
Max. response frequency		450 Hz		300 Hz		300 Hz		350 Hz		100 Hz		100 Hz	
Operation indicator		Orange LED (lights up when the output is ON)											
Environmental resistance	Protection	IP67 (IEC), IP67g (JEM)											
	Ambient temperature	- 25 to + 70 °C - 13 to + 158 °F, Storage: - 30 to + 80 °C - 22 to + 176 °F											
	Ambient humidity	45 to 85 % RH, Storage: 35 to 95 % RH											
	Noise immunity	Power line: 240 Vp, 0.5 μs pulse width (with noise simulator)											
	Voltage withstandability	1,000 V AC for one min. between all supply terminals connected together and enclosure											
	Insulation resistance	50 MΩ, or more, with 250 V DC megger between all supply terminals connected together and enclosure											
	Vibration resistance	10 to 55 Hz frequency, 1.5 mm 0.059 in amplitude in X, Y and Z directions for two hours each											
Shock resistance	1,000 m/s ² acceleration (100 G approx.) in X, Y and Z directions for three times each												
Sensing range variation	Temperature characteristics	Over ambient temperature range - 25 to + 70 °C - 13 to + 158 °F: Within ± 10 % of sensing range at + 20 °C + 68 °F											
	Voltage characteristics	Within ± 2 % for ± 10 % fluctuation of the supply voltage											
Material		Enclosure: Brass (Nickel plated), Sensing part: Nylon, Indicator part: Nylon											
Cable		0.3 mm ² 3-core oil, heat and cold resistant cabtyre cable, 2 m 6.562 ft long											
Cable extension		Extension up to total 100 m 328.084 ft is possible with 0.3 mm ² , or more, cable.											
Weight (Note 2)		65 g approx.		110 g approx.		240 g approx.		65 g approx.		110 g approx.		240 g approx.	
Accessories		Nut: 2 pcs., Toothed lock washer: 1 pc.											

Notes: 1) The maximum operation distance stands for the maximum distance for which the sensor can detect the standard sensing object. The stable sensing range stands for the sensing range for which the sensor can stably detect the standard sensing object even if there is an ambient temperature drift and/or supply voltage fluctuation.
2) The given weight includes the weight of two nuts and one toothed lock washer.

I/O CIRCUIT AND WIRING DIAGRAMS

I/O circuit diagram

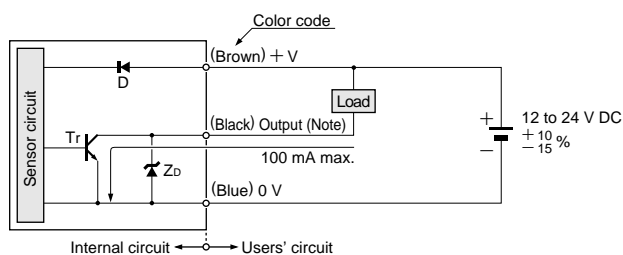

Note: If a capacitive load is directly connected to the output, malfunction may occur.

Symbols ... D : Reverse supply polarity protection diode
Zd: Surge absorption zener diode
Tr : NPN output transistor

Wiring diagram

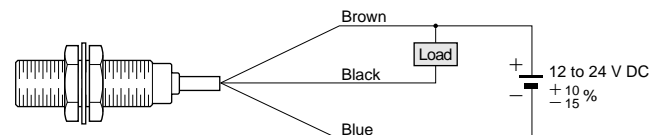

GXL

GL-6

GL-8/8U

Amplifier Built-in
GL-N12

GL-18H/18HL

GX-U/FU

GX-N

GX

Amplifier-separated
GA-10/GH

GX-N

SENSING CHARACTERISTICS (TYPICAL)

GX-N12M GX-N12MB

Sensing field

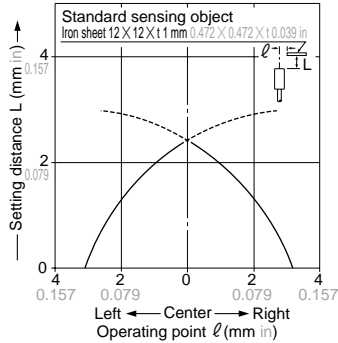

Correlation between sensing object size and sensing range

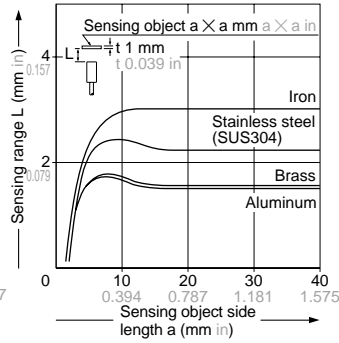

As the sensing object size becomes smaller than the standard size (iron sheet $12 \times 12 \times 1$ mm $0.472 \times 0.472 \times t 0.039$ in), the sensing range shortens as shown in the left figure.

GX-N18M GX-N18MB

Sensing field

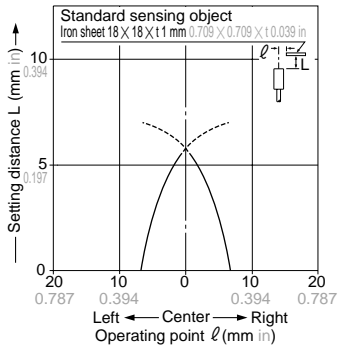

Correlation between sensing object size and sensing range

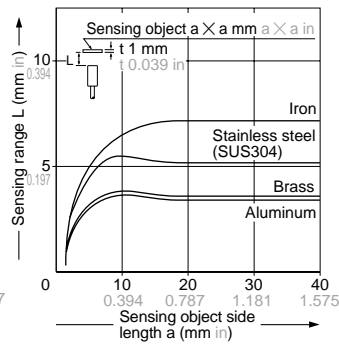

As the sensing object size becomes smaller than the standard size (iron sheet $18 \times 18 \times 1$ mm $0.709 \times 0.709 \times t 0.039$ in), the sensing range shortens as shown in the left figure.

GX-N30M GX-N30MB

Sensing field

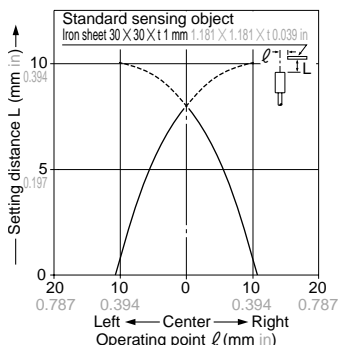

Correlation between sensing object size and sensing range

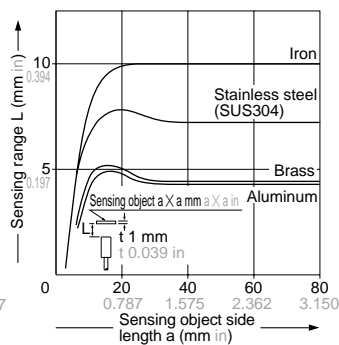

As the sensing object size becomes smaller than the standard size (iron sheet $30 \times 30 \times 1$ mm $1.181 \times 1.181 \times t 0.039$ in), the sensing range shortens as shown in the left figure.

GX-N12ML GX-N12MLB

Sensing field

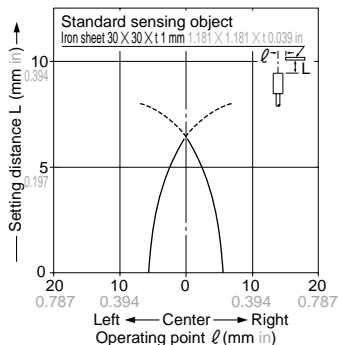

Correlation between sensing object size and sensing range

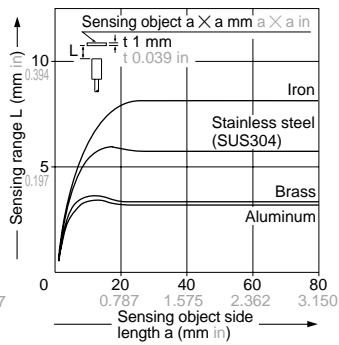

As the sensing object size becomes smaller than the standard size (iron sheet $30 \times 30 \times 1$ mm $1.181 \times 1.181 \times t 0.039$ in), the sensing range shortens as shown in the left figure.

SENSING CHARACTERISTICS (TYPICAL)

GX-N18ML GX-N18MLB

Sensing field

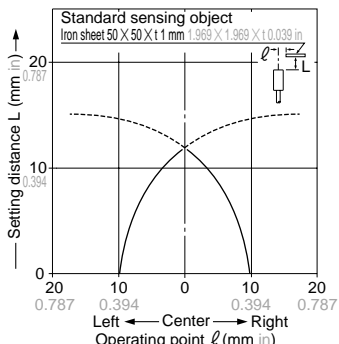

Correlation between sensing object size and sensing range

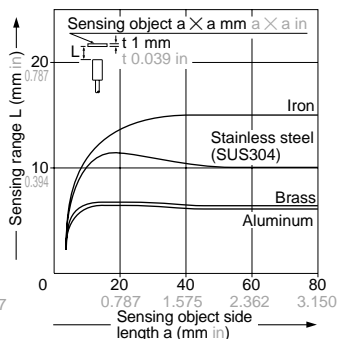

As the sensing object size becomes smaller than the standard size (iron sheet $50 \times 50 \times t 1 \text{ mm}$ $1.969 \times 1.969 \times t 0.039 \text{ in}$), the sensing range shortens as shown in the left figure.

GX-N30ML GX-N30MLB

Sensing field

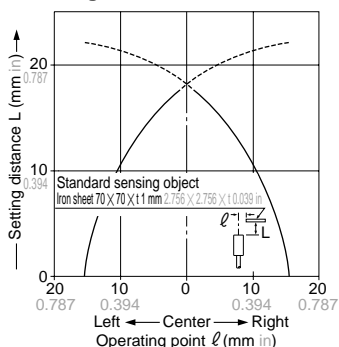

Correlation between sensing object size and sensing range

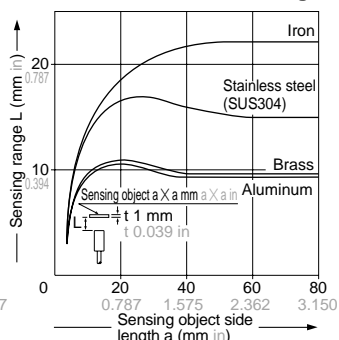

As the sensing object size becomes smaller than the standard size (iron sheet $70 \times 70 \times t 1 \text{ mm}$ $2.756 \times 2.756 \times t 0.039 \text{ in}$), the sensing range shortens as shown in the left figure.

DIMENSIONS (Unit: mm in) The CAD data in the dimensions can be downloaded from the SUNX website: <http://www.sunx.co.jp/>

**GX-N12M
GX-N12MB** Sensor

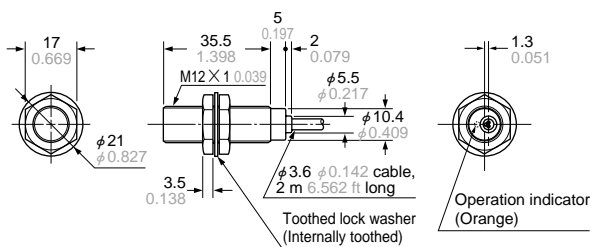

**GX-N12ML
GX-N12MLB** Sensor

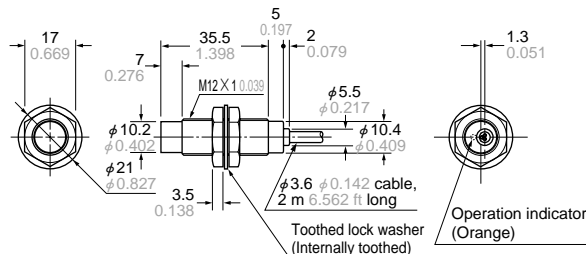

**GX-N18M
GX-N18MB** Sensor

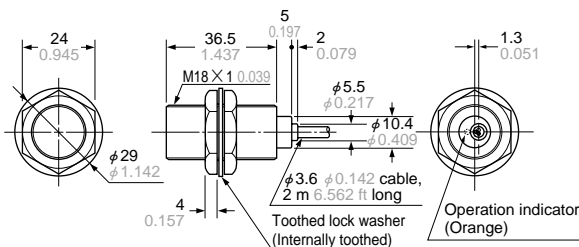

**GX-N18ML
GX-N18MLB** Sensor

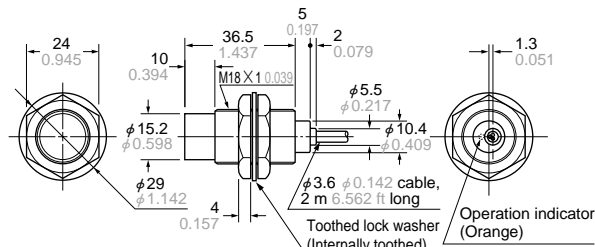

**GX-N30M
GX-N30MB** Sensor

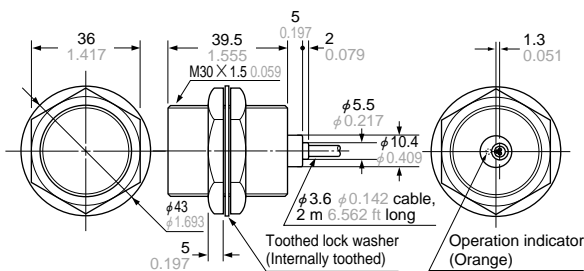

**GX-N30ML
GX-N30MLB** Sensor

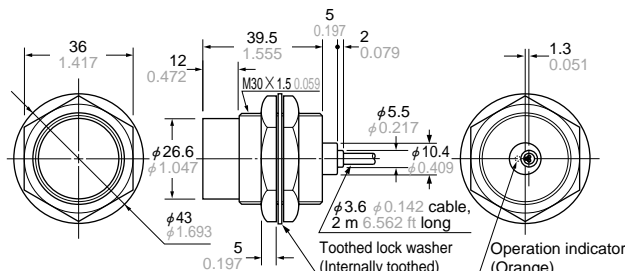

**MS-H12 MS-H18
MS-H30** Protection cover (Optional)

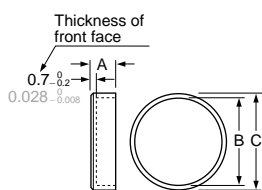

Symbol	A	B	C	Applicable model No.
MS-H12	5 0.197	$\phi 11.5$ $\phi 0.453$	$\phi 14$ $\phi 0.551$	GX-N12M(B)
MS-H18	6 0.236	$\phi 17.5$ $\phi 0.689$	$\phi 20$ $\phi 0.787$	GX-N18M(B)
MS-H30	8 0.315	$\phi 29.4$ $\phi 1.157$	$\phi 33$ $\phi 1.299$	GX-N30M(B)

Amplifier Built-in
GX-L
GX-L-6
GX-L-8/8U
GX-L-12
GX-L-18H/18HL
GX-U/FU
GX-N
GX
Amplifier-separated
GA-10/GH