

阅读申明

- 1.本站收集的数据手册和产品资料都来自互联网，版权归原作者所有。如读者和版权方有任何异议请及时告之，我们将妥善解决。
- 2.本站提供的中文数据手册是英文数据手册的中文翻译，其目的是协助用户阅读，该译文无法自动跟随原稿更新，同时也可能存在翻译上的不当。建议读者以英文原稿为参考以便获得更精准的信息。
- 3.本站提供的产品资料，来自厂商的技术支持或者使用者的心得体会等，其内容可能存在描述上的差异，建议读者做出适当判断。
- 4.如需与我们联系，请发邮件到marketing@iczoom.com，主题请标有“数据手册”字样。

Read Statement

1. The datasheets and other product information on the site are all from network reference or other public materials, and the copyright belongs to the original author and original published source. If readers and copyright owners have any objections, please contact us and we will deal with it in a timely manner.
2. The Chinese datasheets provided on the website is a Chinese translation of the English datasheets. Its purpose is for reader's learning exchange only and do not involve commercial purposes. The translation cannot be automatically updated with the original manuscript, and there may also be improper translations. Readers are advised to use the English manuscript as a reference for more accurate information.
3. All product information provided on the website refer to solutions from manufacturers' technical support or users the contents may have differences in description, and readers are advised to take the original article as the standard.
4. If you have any questions, please contact us at marketing@iczoom.com and mark the subject with "Datasheets" .

GX-U/FU SERIES

DC 2-wire Cylindrical Inductive Proximity Sensor **Amplifier Built-in**



High performance & ease of use



Robust in tightening

The tightening torque has been improved to approx. four times greater than that of conventional models because of its thick case. As the sensor can be securely tightened, it does not get loose due to vibration or shock.

GX-18M(B) Conventional model **GX-18MU(B)**
 19.6 N·m or less 4 times approx. 80 N·m or less



Compact size: $\phi 5.4 \text{ mm}$ $\phi 0.213 \text{ in}$

GX-5SU(B) is just 5.4 mm 0.213in in diameter, the smallest in existing DC two-wire sensors. It saves you space.

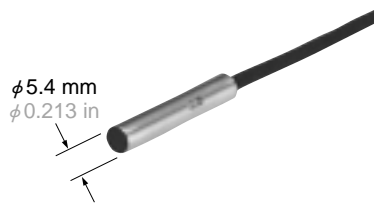

Long sensing range

The **GX-U** series features 1.6 times longer sensing range than conventional models. As it can be mounted at a sufficient distance from the object, there is no fear of the sensor and the object colliding.

GX-12MLU(B)



GX-12ML(B) Conventional model



2-color indicator

The normally open type is equipped with a 2-color indicator. (The normally closed type has the operation indicator instead.) The operation is easily observable from any direction because the entire sensor tail lights up.



Simple wiring

The wiring cost is considerably reduced as it is DC 2-wire type. Further, each of **GX-12MU(B)**, **GX-18MU(B)**, **GX-30MU(B)** is available as a pigtailed model (300 mm 11.811 in long cable with attached connector) that makes replacement easy and quick.

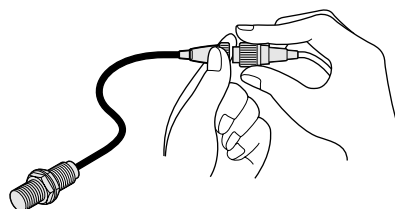

Spatter-resistant type available

As the enclosure is entirely coated by fluorine resin, the sensor can be safely used at a place where welding spatters fly around. Both the pigtail cable and the mating cable are also spatter-resistant.



APPLICATIONS

Detecting traveling aluminum pallets

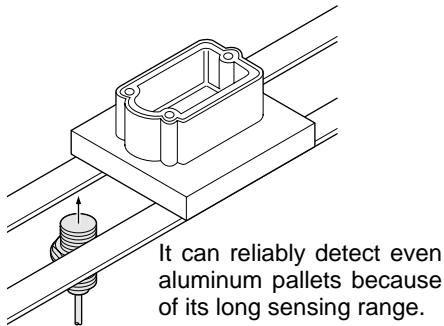

Controlling depth of drilling

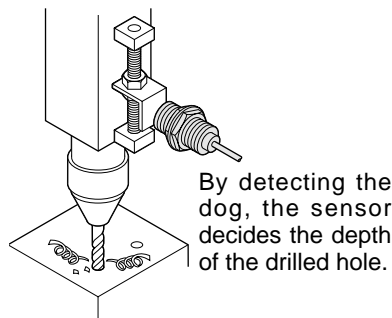

Positioning object at welding station (GX-F□U-J only)

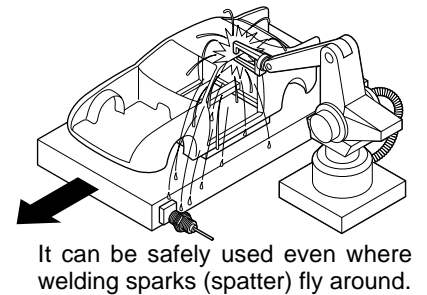

ORDER GUIDE

Standard type

| Type | Appearance (mm in) | Sensing range (Note) | Model No. | Output | Output operation |
|-------------------|--------------------|--|------------------|-------------------------------|------------------|
| Shielded type | | 1.5 mm 0.059 in ← Maximum operation distance | GX-5SU | Non-contact DC 2-wire type | Normally open |
| | | (0 to 1.2 mm 0 to 0.047 in) ← Stable sensing range | GX-5SUB | | Normally closed |
| | | 2 mm 0.079 in | GX-8MU | | Normally open |
| | | (0 to 1.6 mm 0 to 0.063 in) | GX-8MUB | | Normally closed |
| | | 3 mm 0.118 in | GX-12MU | | Normally open |
| | | (0 to 2.4 mm 0 to 0.094 in) | GX-12MUB | | Normally closed |
| | | 7 mm 0.276 in | GX-18MU | | Normally open |
| | | (0 to 5.6 mm 0 to 0.220 in) | GX-18MUB | | Normally closed |
| | | 10 mm 0.394 in | GX-30MU | | Normally open |
| | | (0 to 8 mm 0 to 0.315 in) | GX-30MUB | | Normally closed |
| Non-shielded type | | 4 mm 0.157 in | GX-8MLU | Normally open | |
| | | (0 to 3.2 mm 0 to 0.126 in) | GX-8MLUB | Normally closed | |
| | | 8 mm 0.315 in | GX-12MLU | Normally open | |
| | | (0 to 6.4 mm 0 to 0.252 in) | GX-12MLUB | Normally closed | |
| | | 15 mm 0.591 in | GX-18MLU | Normally open | |
| | | (0 to 12 mm 0 to 0.472 in) | GX-18MLUB | Normally closed | |
| | | 22 mm 0.866 in | GX-30MLU | Normally open | |
| | | (0 to 17.6 mm 0 to 0.693 in) | GX-30MLUB | Normally closed | |

Note: The maximum operation distance stands for the maximum distance for which the sensor can detect the standard sensing object. The stable sensing range stands for the sensing range for which the sensor can stably detect the standard sensing object even if there is an ambient temperature drift and/or supply voltage fluctuation.

GX-U/FU

ORDER GUIDE

5 m 16.404 ft cable length type and pigtailed type

5 m 16.404 ft cable length type (standard : 2 m 6.562 ft) and pigtailed type (standard: cable type) are also available.

• Table of Model Nos.

| Type | Standard | 5 m 16.404 ft cable length type | Pigtailed type (Note) |
|--------------------------------|------------------------------------|---------------------------------|-----------------------|
| Non-threaded type | GX-5SU | GX-5SU-C5 | _____ |
| | GX-5SUB | GX-5SUB-C5 | _____ |
| Shielded type Threaded type | GX-8MU | GX-8MU-C5 | _____ |
| | GX-8MUB | GX-8MUB-C5 | _____ |
| | GX-12MU | GX-12MU-C5 | GX-12MU-J |
| | GX-12MUB | GX-12MUB-C5 | GX-12MUB-J |
| | GX-18MU | GX-18MU-C5 | GX-18MU-J |
| | GX-18MUB | GX-18MUB-C5 | GX-18MUB-J |
| | GX-30MU | GX-30MU-C5 | GX-30MU-J |
| | GX-30MUB | GX-30MUB-C5 | GX-30MUB-J |
| | Non-shielded type Threaded type | GX-8MLU | GX-8MLU-C5 |
| GX-8MLUB | | GX-8MLUB-C5 | _____ |
| GX-12MLU | | GX-12MLU-C5 | GX-12MLU-J |
| GX-12MLUB | | GX-12MLUB-C5 | GX-12MLUB-J |
| GX-18MLU | | GX-18MLU-C5 | GX-18MLU-J |
| GX-18MLUB | | GX-18MLUB-C5 | GX-18MLUB-J |
| GX-30MLU | | GX-30MLU-C5 | GX-30MLU-J |
| GX-30MLUB | | GX-30MLUB-C5 | GX-30MLUB-J |

Note: Please order the suitable mating cable separately for pigtailed type.

• Mating cable

| Model No. | Description | |
|-----------|--------------------------|---|
| CN-22G-C2 | Length: 2 m 6.562 ft | 0.3 mm ² 2-core flame-resistant, spatter-resistant cable (outer dia ϕ 3.6 mm ϕ 0.142 in) with connector at one end |
| CN-22G-C5 | Length: 5 m 16.404 ft | |

• CN-22G-C2, CN-22G-C5

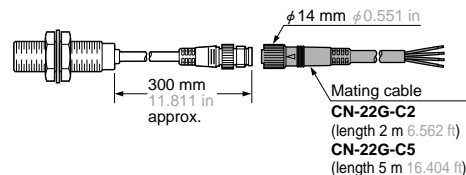

ORDER GUIDE

Spatter-resistant type

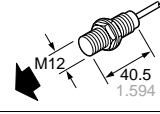
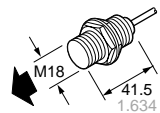
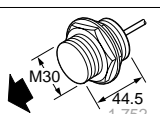
| Type | Appearance (mm in) | Sensing range (Note) | Model No. | Output | Output operation |
|--------------------------------|---|--|-------------------|-------------------------------|------------------|
| Shielded type Threaded type |  | 3 mm 0.118 in ← Maximum operation distance (0 to 2.4 mm 0 to 0.094 in) ← Stable sensing range | GX-F12MU-J | Non-contact DC 2-wire type | Normally open |
| |  | 7 mm 0.276 in (0 to 5.6 mm 0 to 0.220 in) | GX-F18MU-J | | |
| |  | 10 mm 0.394 in (0 to 8 mm 0 to 0.315 in) | GX-F30MU-J | | |

Note: The maximum operation distance stands for the maximum distance for which the sensor can detect the standard sensing object.
The stable sensing range stands for the sensing range for which the sensor can stably detect the standard sensing object even if there is an ambient temperature drift and/or supply voltage fluctuation.

• Mating cable

| Model No. | Description | |
|------------------|--------------------------|---|
| CN-22G-C2 | Length: 2 m 6.562 ft | 0.3 mm ² 2-core flame-resistant, spatter-resistant cable (outer dia ϕ 3.6 mm ϕ 0.142 in) with connector at one end |
| CN-22G-C5 | Length: 5 m 16.404 ft | |

• CN-22G-C2, CN-22G-C5

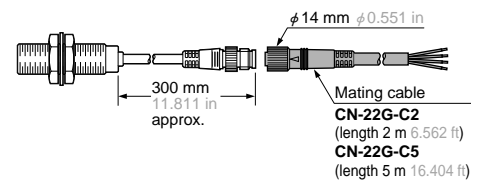

OPTIONS

| Designation | Model No. | Description | |
|-------------------------|---------------|-----------------------|---|
| Sensor mounting bracket | MS-SS5 | For GX-5SU(B) | The sensor is easily mounted with this bracket. |
| Protection cover | MS-H12 | For GX-12MU(B) | It protects the sensing surface from welding sparks (spatter), etc. |
| | MS-H18 | For GX-18MU(B) | |
| | MS-H30 | For GX-30MU(B) | |

Sensor mounting bracket

- MS-SS5

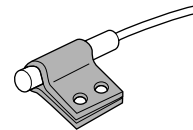

Protection cover

- MS-H12
- MS-H18
- MS-H30

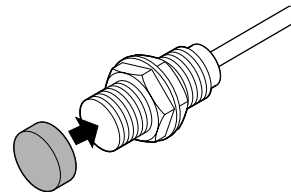

GX-U/FU

SPECIFICATIONS

Standard type

| Item | Model No. | Type | Shielded type | | | | | Non-shielded type | | | |
|----------------------------------|------------------|---|---|---|---|---|---|---|---|---|---|
| | | | Non-threaded type | | Threaded type | | | Threaded type | | | |
| | | | Normally open | Normally closed | GX-5SU | GX-8MU | GX-12MU | GX-18MU | GX-30MU | GX-8MLU | GX-12MLU |
| Max. operation distance (Note 1) | | | 1.5 mm 0.059 in ±10% | 2 mm 0.079 in ±10% | 3 mm 0.118 in ±10% | 7 mm 0.276 in ±10% | 10 mm 0.394 in ±10% | 4 mm 0.157 in ±10% | 8 mm 0.315 in ±10% | 15 mm 0.591 in ±10% | 22 mm 0.866 in ±10% |
| Stable sensing range (Note 1) | | | 0 to 1.2 mm 0 to 0.047 in | 0 to 1.6 mm 0 to 0.063 in | 0 to 2.4 mm 0 to 0.094 in | 0 to 5.6 mm 0 to 0.220 in | 0 to 8 mm 0 to 0.315 in | 0 to 3.2 mm 0 to 0.126 in | 0 to 6.4 mm 0 to 0.252 in | 0 to 12 mm 0 to 0.472 in | 0 to 17.6 mm 0 to 0.693 in |
| Standard sensing object | | | Iron sheet 6 X 6 X t 1 mm 0.236 X 0.236 X t 0.039 in | Iron sheet 8 X 8 X t 1 mm 0.315 X 0.315 X t 0.039 in | Iron sheet 12 X 12 X t 1 mm 0.472 X 0.472 X t 0.039 in | Iron sheet 18 X 18 X t 1 mm 0.709 X 0.709 X t 0.039 in | Iron sheet 30 X 30 X t 1 mm 1.181 X 1.181 X t 0.039 in | Iron sheet 20 X 20 X t 1 mm 0.787 X 0.787 X t 0.039 in | Iron sheet 30 X 30 X t 1 mm 1.181 X 1.181 X t 0.039 in | Iron sheet 50 X 50 X t 1 mm 1.969 X 1.969 X t 0.039 in | Iron sheet 70 X 70 X t 1 mm 2.756 X 2.756 X t 0.039 in |
| Hysteresis | | | 20 % or less of operation distance | | | | | | | | |
| Supply voltage | | | 12 to 24 V DC $\pm\frac{10}{15}\%$ Ripple P-P 10 % or less | | | | | | | | |
| Current consumption (Note 2) | | | 0.8 mA or less | | | | | | | | |
| Output | | | Non-contact DC 2-wire type • Load current: 3 to 70 mA (Note 3) • Residual voltage: 3 V or less (Note 4) | | | | | | | | |
| | | Utilization category | DC-12 or DC-13 | | | | | | | | |
| | | Short-circuit protection | Incorporated | | | | | | | | |
| Max. response frequency | | | 1.7 kHz | 1.2 kHz | 1.2 kHz | 500 Hz | 350 Hz | 1 kHz | 650 Hz | 350 Hz | 220 Hz |
| Operation indicator | | | Normally closed type: Orange LED (lights up when the output is ON) | | | | | | | | |
| 2-color indicator | | | Normally open type: Lights up in green under stable sensing condition, lights up in orange under unstable sensing condition | | | | | | | | |
| Environmental resistance | | Pollution degree | 3 (Industrial environment) | | | | | | | | |
| | | Protection | IP67 (IEC), IP67g (JEM) | | | | | | | | |
| | | Ambient temperature | - 25 to + 70 °C - 13 to + 158 °F, Storage: - 30 to + 80 °C - 22 to + 176 °F | | | | | | | | |
| | | Ambient humidity | 45 to 85 % RH, Storage: 35 to 95 % RH | | | | | | | | |
| | | EMC | EN 50081-2, EN 50082-2, EN 60947-5-2 | | | | | | | | |
| | | Voltage withstandability | 1,000 V AC for one min. between all supply terminals connected together and enclosure | | | | | | | | |
| | | Insulation resistance | 50 MΩ, or more, with 250 V DC megger between all supply terminals connected together and enclosure | | | | | | | | |
| | | Vibration resistance | 10 to 55 Hz frequency, 1.5 mm 0.059 in amplitude in X, Y and Z directions for two hours each | | | | | | | | |
| | Shock resistance | 1,000 m/s ² acceleration (100 G approx.) in X, Y and Z directions for three times each | | | | | | | | | |
| Sensing range variation | | Temperature characteristics | Over ambient temperature range - 25 to + 70°C - 13 to + 158 °F: within ± 10 % of sensing range at + 20 °C + 68°F | | | | | | | | |
| | | Voltage characteristics | Within ± 2 % for ± 10 % fluctuation of the supply voltage | | | | | | | | |
| Material | | | Enclosure: Brass (Nickel plated) [However, Stainless steel (SUS303) for GX-5SU(B), GX-8MU(B) and GX-8MLU(B)] Sensing part: Nylon [However, polyalylate for GX-5SU(B)], Indicator part: Nylon [excluding GX-5SU(B)] | | | | | | | | |
| Cable | | | 0.3 mm ² [0.15 mm ² for GX-5SU(B), GX-8MU(B) and GX-8MLU(B)] 2-core oil, heat and cold resistant cabtyre cable, 2 m 6.562 ft long | | | | | | | | |
| Cable extension | | | Extension up to total 50 m 164.042 ft is possible with 0.3 mm ² , or more, cable. | | | | | | | | |
| Weight (Note 5) | | | 20 g approx. | 30 g approx. | 55 g approx. | 95 g approx. | 220 g approx. | 30 g approx. | 55 g approx. | 95 g approx. | 220 g approx. |
| Accessories | | | Nut: 2 pcs., Toothed lock washer: 1 pc. | | | | | | | | |

- Notes: 1) The maximum operation distance stands for the maximum distance for which the sensor can detect the standard sensing object.
The stable sensing range stands for the sensing range for which the sensor can stably detect the standard sensing object even if there is an ambient temperature drift and/or supply voltage fluctuation.
- 2) It is the leakage current when the output is in the OFF state.
- 3) The maximum load current varies depending on the ambient temperature. Refer to 'I/O CIRCUIT AND WIRING DIAGRAMS' on p.727~ for more details.
- 4) When the cable is extended, the residual voltage becomes larger.
- 5) The weight of the threaded type includes the weight of two nuts and one toothed lock washer.

Spatter-resistant type

| Item | Model No. | Type | Shielded type | | |
|-----------------|-----------|---------------|--|--------------|---------------|
| | | | Threaded type | | |
| | | Normally open | GX-F12MU-J | GX-F18MU-J | GX-F30MU-J |
| Material | | | Enclosure: Brass (Fluorine resin coated), Sensing part: Polyalylate (Fluorine resin coated), Indicator part: Polyalylate | | |
| Cable | | | 0.3 mm ² 2-core spatter-resistant cable, 0.3 m 0.984 ft long with round type connector | | |
| Cable extension | | | Extension up to total 50 m 164.042 ft is possible with 0.3 mm ² , or more, cable. | | |
| Weight (Note) | | | 35 g approx. | 75 g approx. | 200 g approx. |
| Accessories | | | Nut: 2 pcs. (Fluorine resin coated), Toothed lock washer: 1 pc. (Fluorine resin coated) | | |

The specifications other than the above-mentioned are identical to that of the standard type (GX-12MU, GX-18MU, GX-30MU).

Note: The given weight includes the weight of two nuts and one toothed lock washer.

I/O CIRCUIT AND WIRING DIAGRAMS

GX-□U(B)

I/O circuit diagram

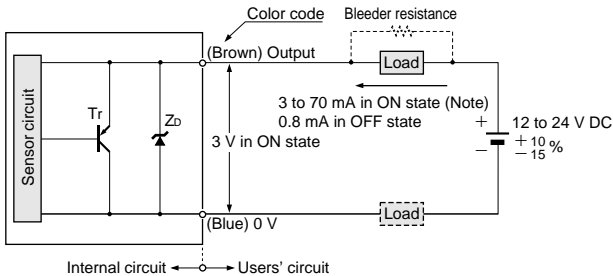

Symbols ... Z_d: Surge absorption zener diode
Tr: PNP output transistor

Note: The maximum load current varies depending on the ambient temperature.

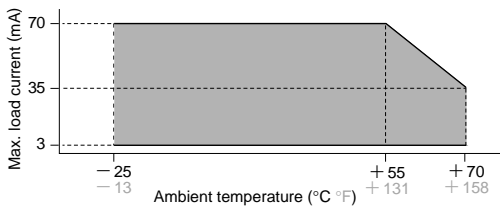

Wiring diagram

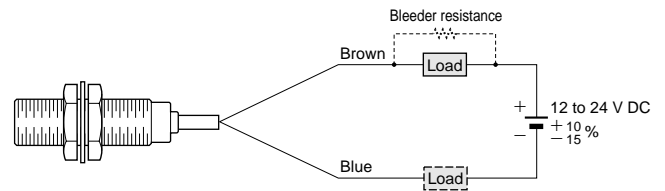

Conditions for the load

- 1) The load should not be actuated by the leakage current (0.8 mA) in the OFF state.
- 2) The load should be actuated by (supply voltage - 3 V) in the ON state.
- 3) The current in the ON state should be between 3 to 70 mA DC.
[In case the current is less than 3 mA, connect a bleeder resistance] in parallel to the load so that a current of 3 mA, or more, flows.

GX-□U(B)-J

I/O circuit diagram

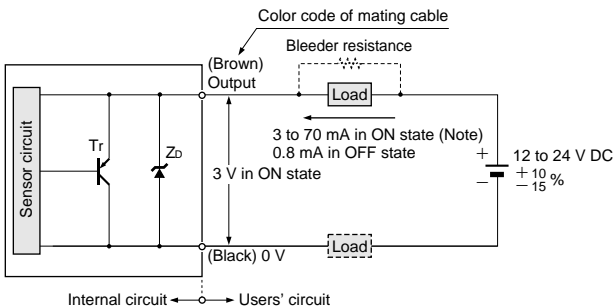

Symbols ... Z_d: Surge absorption zener diode
Tr: PNP output transistor

Note: The maximum load current varies depending on the ambient temperature.

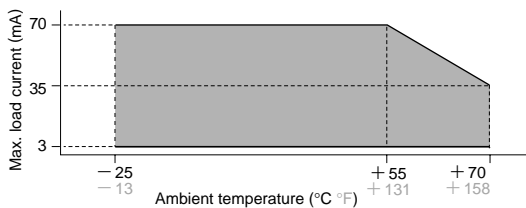

Wiring diagram

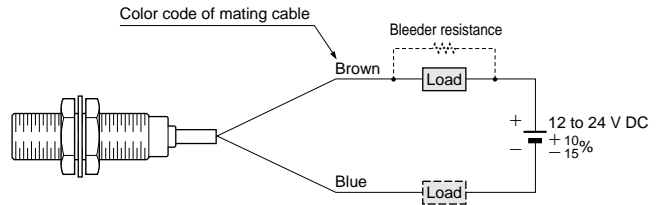

Conditions for the load

- 1) The load should not be actuated by the leakage current (0.8 mA) in the OFF state.
- 2) The load should be actuated by (supply voltage - 3 V) in the ON state.
- 3) The current in the ON state should be between 3 to 70 mA DC.
[In case the current is less than 3 mA, connect a bleeder resistance] in parallel to the load so that a current of 3 mA, or more, flows.

Connector pin position

GX-□U-J (Normally open)

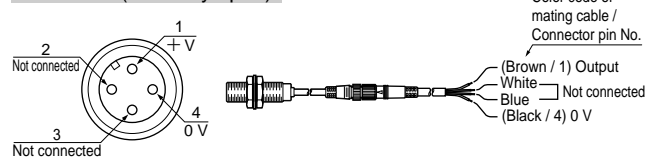

GX-□UB-J (Normally closed)

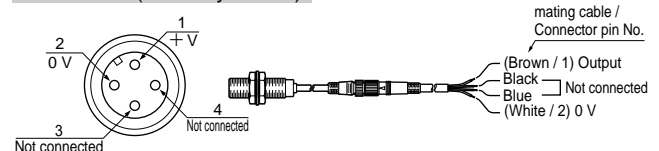

GX-U/FU

I/O CIRCUIT AND WIRING DIAGRAMS

GX-F□U-J

I/O circuit diagram

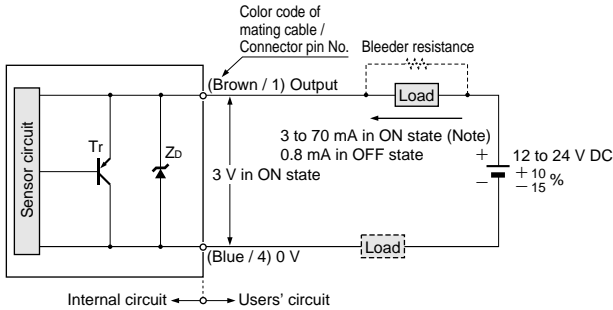

Symbols ... Z_d: Surge absorption zener diode
Tr: PNP output transistor

Note: The maximum load current varies depending on the ambient temperature.

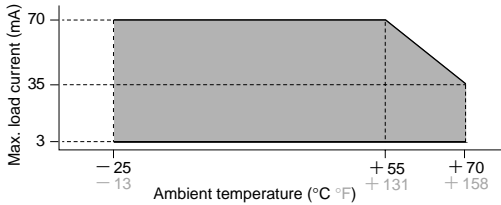

Wiring diagram

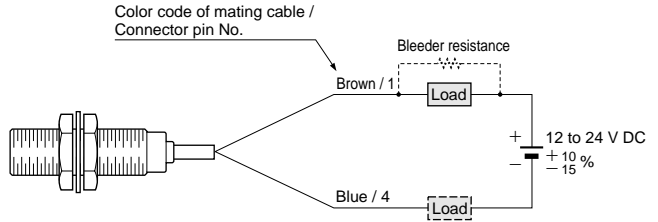

Conditions for the load

- 1) The load should not be actuated by the leakage current (0.8 mA) in the OFF state.
- 2) The load should be actuated by (supply voltage - 3 V) in the ON state.
- 3) The current in the ON state should be between 3 to 70 mA DC.
[In case the current is less than 3 mA, connect a bleeder resistance in parallel to the load so that a current of 3 mA, or more, flows.]

Connector pin position

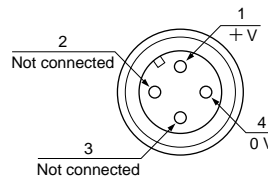

SENSING CHARACTERISTICS (TYPICAL)

GX-5SU GX-5SUB

Sensing field

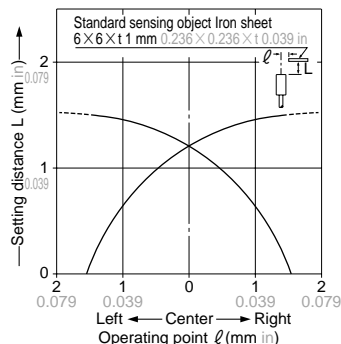

Correlation between sensing object size and sensing range

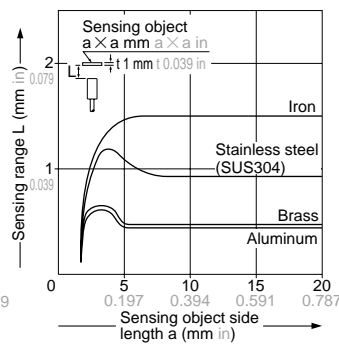

As the sensing object size becomes smaller than the standard size (iron sheet 6×6×t 1 mm 0.236×0.236×t 0.039 in), the sensing range shortens as shown in the left figure.

GX-8MU GX-8MUB

Sensing field

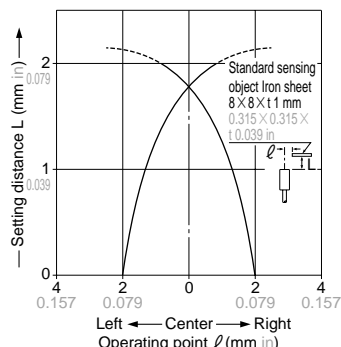

Correlation between sensing object size and sensing range

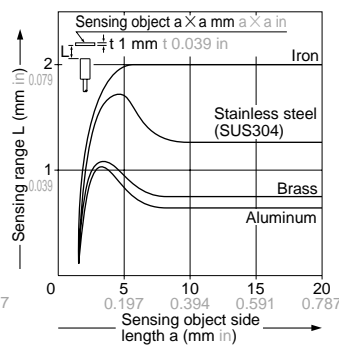

As the sensing object size becomes smaller than the standard size (iron sheet 8×8×t 1 mm 0.315×0.315×t 0.039 in), the sensing range shortens as shown in the left figure.

SENSING CHARACTERISTICS (TYPICAL)

GX-12MU GX-12MUB GX-F12MU-J

Sensing field

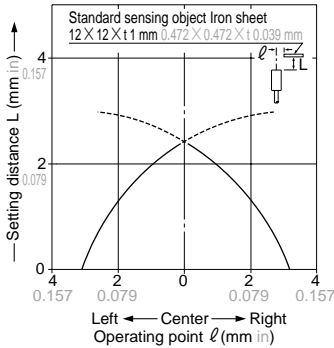

Correlation between sensing object size and sensing range

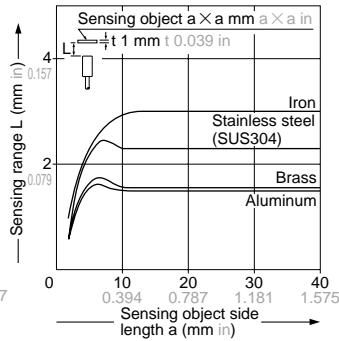

As the sensing object size becomes smaller than the standard size (iron sheet 12×12×t 1 mm 0.472×0.472×t 0.039 in), the sensing range shortens as shown in the left figure.

GX-18MU GX-18MUB GX-F18MU-J

Sensing field

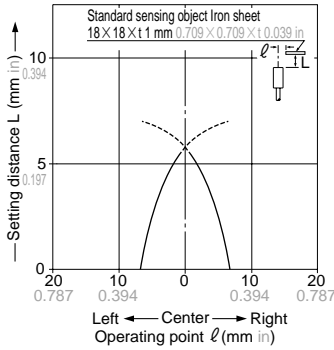

Correlation between sensing object size and sensing range

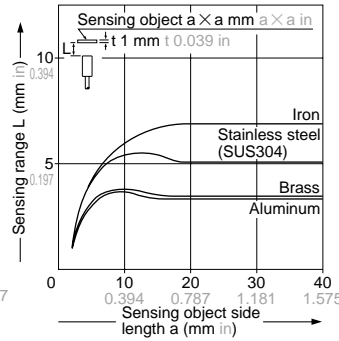

As the sensing object size becomes smaller than the standard size (iron sheet 18×18×t 1 mm 0.709×0.709×t 0.039 in), the sensing range shortens as shown in the left figure.

GX-30MU GX-30MUB GX-F30MU-J

Sensing field

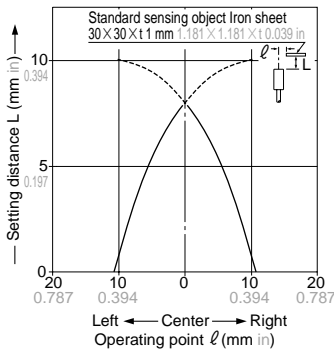

Correlation between sensing object size and sensing range

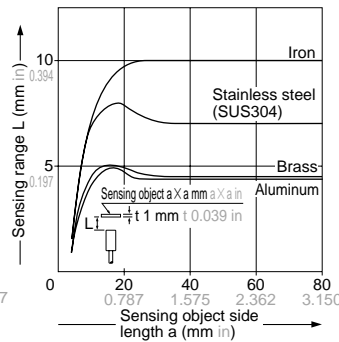

As the sensing object size becomes smaller than the standard size (iron sheet 30×30×t 1 mm 1.181×1.181×t 0.039 in), the sensing range shortens as shown in the left figure.

GX-8MLU GX-8MLUB

Sensing field

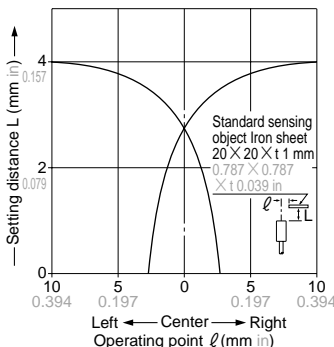

Correlation between sensing object size and sensing range

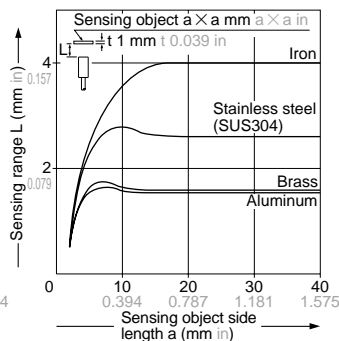

As the sensing object size becomes smaller than the standard size (iron sheet 20×20×t 1 mm 0.787×0.787×t 0.039 in), the sensing range shortens as shown in the left figure.

GX-U/FU

SENSING CHARACTERISTICS (TYPICAL)

GX-12MLU GX-12MLUB

Sensing field

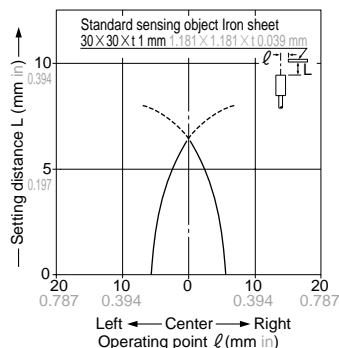

Correlation between sensing object size and sensing range

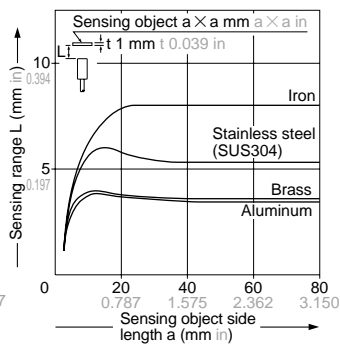

As the sensing object size becomes smaller than the standard size (iron sheet $30 \times 30 \times t$ mm $1.181 \times 1.181 \times t$ 0.039 in), the sensing range shortens as shown in the left figure.

GX-18MLU GX-18MLUB

Sensing field

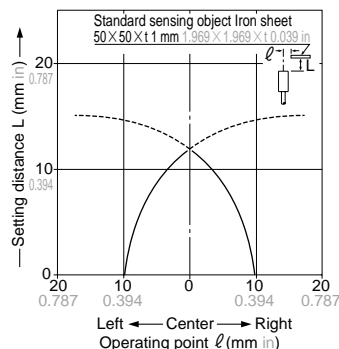

Correlation between sensing object size and sensing range

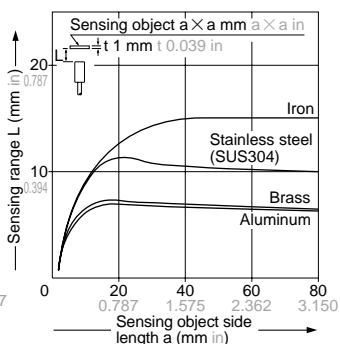

As the sensing object size becomes smaller than the standard size (iron sheet $50 \times 50 \times t$ mm $1.969 \times 1.969 \times t$ 0.039 in), the sensing range shortens as shown in the left figure.

GX-30MLU GX-30MLUB

Sensing field

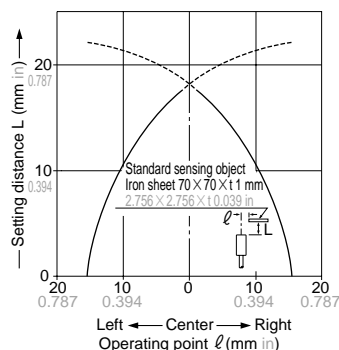

Correlation between sensing object size and sensing range

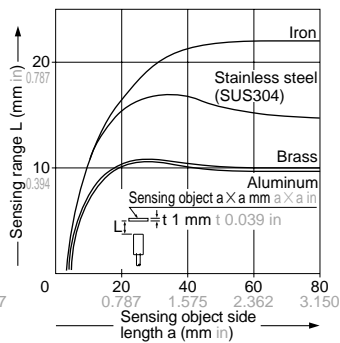

As the sensing object size becomes smaller than the standard size (iron sheet $70 \times 70 \times t$ mm $2.756 \times 2.756 \times t$ 0.039 in), the sensing range shortens as shown in the left figure.

PRECAUTIONS FOR PROPER USE

Refer to p.1152~ for general precautions.



This product is not a safety sensor. Its use is not intended or designed to protect life and prevent body injury or property damage from dangerous parts of machinery. It is a normal object detection sensor.

Mounting

- The tightening torque should be under the value given below.

Mounting with a set screw

- Tighten with the cup-point of a set screw (M4 or less).

<Non-threaded type>

| Model No. | A (mm in) | B (mm in) | Tightening torque |
|-----------|---------------------------|-----------|-------------------|
| GX-5SU(B) | 5 to 30 0.197 to 1.181 | 3 0.118 | 0.78 N·m |

- Do not fix on the operation indicator or opposite to it.

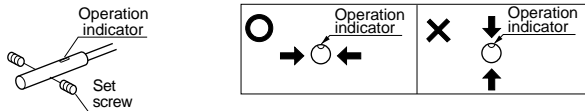

Mounting with nut

<Shielded threaded type>

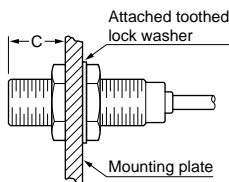

<Non-shielded threaded type>

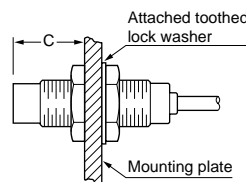

| Model No. | Dimension C (mm in) | Tightening torque |
|--------------------------|----------------------------|-------------------|
| GX-8MU(B) | 3 to 10.3 0.118 to 0.406 | 5.9 N·m |
| | 10.3 0.406 or more | 11.8 N·m |
| GX-12MU(B) GX-F12MU-J | 3.5 to 13.5 0.138 to 0.531 | 10 N·m |
| | 13.5 0.531 or more | 20 N·m |
| GX-18MU(B) GX-F18MU-J | 4 to 18 0.157 to 0.709 | 45 N·m |
| | 18 0.709 or more | 80 N·m |
| GX-30MU(B) GX-F30MU-J | 5 to 21 0.197 to 0.827 | 80 N·m |
| | 21 0.827 or more | 180 N·m |
| GX-8MLU(B) | 12 0.472 or more | 11.8 N·m |
| GX-12MLU(B) | 15 0.591 or more | 20 N·m |
| GX-18MLU(B) | 25 0.984 or more | 80 N·m |
| GX-30MLU(B) | 30 1.181 or more | 180 N·m |

Note: Mount such that the nuts do not protrude from the threaded portion.

Distance from surrounding metal

- As metal around the sensor may affect the sensing performance, pay attention to the following points.

Influence of surrounding metal

- The surrounding metal will affect the sensing performance. Keep the minimum distance specified in the table below.

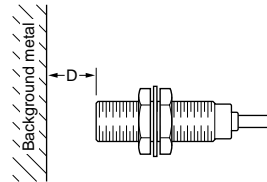

| Model No. | D (mm in) |
|--------------------------|-----------|
| GX-5SU(B) | 4.5 0.177 |
| GX-8MU(B) | 4.5 0.177 |
| GX-12MU(B) GX-F12MU-J | 8 0.315 |
| GX-18MU(B) GX-F18MU-J | 20 0.787 |
| GX-30MU(B) GX-F30MU-J | 40 1.575 |
| GX-8MLU(B) | 8 0.315 |
| GX-12MLU(B) | 22 0.866 |
| GX-18MLU(B) | 45 1.772 |
| GX-30MLU(B) | 75 2.953 |

Embedding of the sensor in metal

- Sensing range may decrease if the sensor is completely embedded in metal. Especially for the non-threaded type and the non-shielded type, keep the minimum distance specified in the table below.

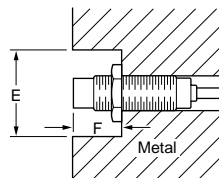

| Model No. | E (mm in) | F (mm in) |
|-------------|-------------|-----------|
| GX-5SU(B) | φ12 φ0.472 | 3 0.118 |
| GX-8MLU(B) | φ24 φ0.945 | 12 0.472 |
| GX-12MLU(B) | φ50 φ1.969 | 15 0.591 |
| GX-18MLU(B) | φ75 φ2.953 | 25 0.984 |
| GX-30MLU(B) | φ105 φ4.134 | 30 1.181 |

Note: With the non-shielded type, the sensing range may vary depending on the position of the nuts.

Mutual interference

- When two or more sensors are installed in parallel or face to face, keep the minimum separation distance specified below to avoid mutual interference.

Face to face mounting



Parallel mounting

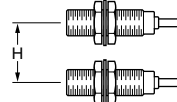

| Model No. | G (mm in) | H (mm in) |
|--------------------------|------------|-----------|
| GX-5SU(B) | 19 0.748 | 14 0.551 |
| GX-8MU(B) | 20 0.787 | 15 0.591 |
| GX-12MU(B) GX-F12MU-J | 35 1.378 | 20 0.787 |
| GX-18MU(B) GX-F18MU-J | 70 2.756 | 45 1.772 |
| GX-30MU(B) GX-F30MU-J | 115 4.528 | 70 2.756 |
| GX-8MLU(B) | 60 2.362 | 45 1.772 |
| GX-12MLU(B) | 145 5.709 | 95 3.740 |
| GX-18MLU(B) | 250 9.843 | 165 6.496 |
| GX-30MLU(B) | 350 13.780 | 250 9.843 |

GX-U/FU

PRECAUTIONS FOR PROPER USE

Refer to p.1152~ for general precautions.

Sensing range

- The sensing range is specified for the standard sensing object. With a non-ferrous metal, the sensing range is obtained by multiplying with the correction coefficient specified below.

Correction coefficient

| Model No. \ Metal | Iron | Stainless steel (SUS304) | Brass | Aluminum |
|--|------|--------------------------|--------------|--------------|
| GX-5SU(B) | 1 | 0.63 approx. | 0.32 approx. | 0.30 approx. |
| GX-8MU(B) | 1 | 0.59 approx. | 0.32 approx. | 0.29 approx. |
| GX-12MU(B) GX-F12MU-J | 1 | 0.75 approx. | 0.51 approx. | 0.49 approx. |
| GX-18MU(B) GX-F18MU-J | 1 | 0.75 approx. | 0.50 approx. | 0.48 approx. |
| GX-30MU(B) GX-F30MU-J | 1 | 0.69 approx. | 0.44 approx. | 0.42 approx. |
| GX-8MLU(B) | 1 | 0.64 approx. | 0.38 approx. | 0.38 approx. |
| GX-12MLU(B) | 1 | 0.67 approx. | 0.44 approx. | 0.43 approx. |
| GX-18MLU(B) | 1 | 0.68 approx. | 0.45 approx. | 0.43 approx. |
| GX-30MLU(B) | 1 | 0.67 approx. | 0.44 approx. | 0.43 approx. |

Note: The sensing range also changes if the sensing object is plated.

Protection cover (Optional)

- It protects the sensing surface from welding sparks (spatter), etc.

Mounting method

Protection cover

Sensor

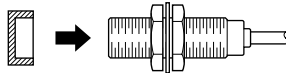

Material: Fluorine resin

| Model No. | Applicable model No. |
|---------------|----------------------|
| MS-H12 | GX-12MU(B) |
| MS-H18 | GX-18MU(B) |
| MS-H30 | GX-30MU(B) |

Note: Mount the protection cover so that there is no gap between it and the sensing surface.

Others

- Do not use during the initial transient time (50 ms) after the power supply is switched on.
- When the sensor is mounted on a moving base, stress should not be applied to the sensor cable joint.

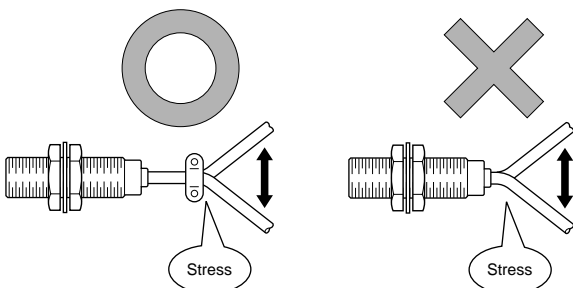

Wiring

- The sensor must be connected to a power supply via a load. If the sensor is connected to a power supply without a load, the short-circuit protection makes the sensor inoperable. (The output stays in the OFF state and the indicator does not light up.) In this case, rectify by connecting the power supply via a load. Now, the sensor becomes operable. Further, take care that if the power supply is connected with reverse polarity without a load, the sensor will get damaged.

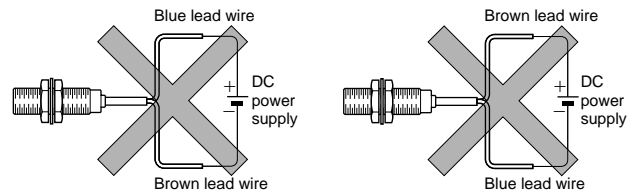

- For series connection (AND circuit) or parallel connection (OR circuit) of sensors, take care of the following.

Series connection (AND circuit)

When all sensors are in the ON state, the load voltage V_{RL} is given by:
 $V_{RL} = V_{CC} - n \times 3 \text{ (V)}$

V_{CC} : supply voltage (24 V DC max.)
 n : number of sensors

Make sure that the load can work properly at this voltage.

Note: The output is generated normally even if the indicator does not light up properly.

Parallel connection (OR circuit)

When all sensors are in the OFF state, the load leakage current I_{CC} is given by:

$$I_{CC} = n \times 0.8 \text{ (mA)} \text{ (n: number of sensors)}$$

Make sure that the load can work properly.

Note: The load current in the ON state is given by:

$$I_L = \frac{V_{CC} - 3 \text{ V}}{\text{Load resistance}} \text{ (mA)}$$

The load current must be $3 \text{ mA} \times n \leq I_L \leq 70 \text{ mA}$ (n: number of sensors turned ON)

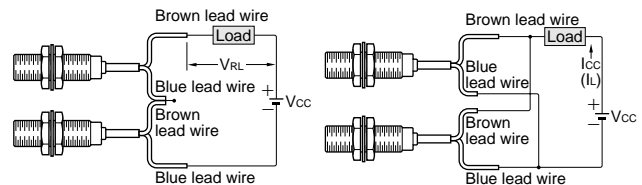

- The residual voltage of the sensor is 3 V. Before connecting a relay as the load, take care of its actuation voltage. (Some 12 V relays may not be usable.)

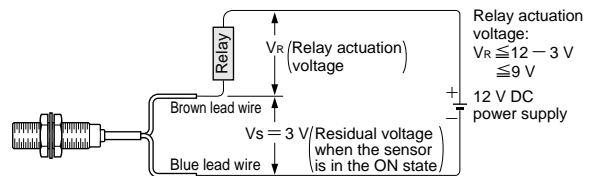

2-color indicator (Normally open type only)

- When the sensing object is in the stable sensing range, the LED lights up in green, and when the sensing object is in the unstable sensing range, the LED lights up in orange. While the LED lights up in green, the sensing is performed stably without being affected by temperature drifts or voltage fluctuations.

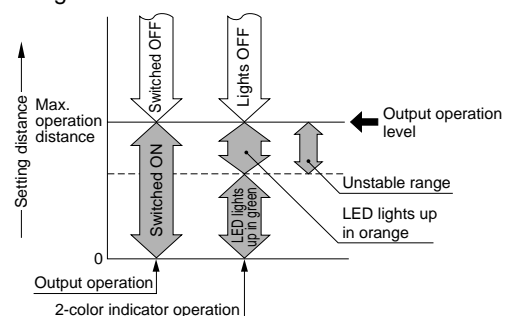

DIMENSIONS (Unit: mm in)

The CAD data in the dimensions can be downloaded from the SUNX website: <http://www.sunx.co.jp/>

GX-5SU GX-5SUB Sensor

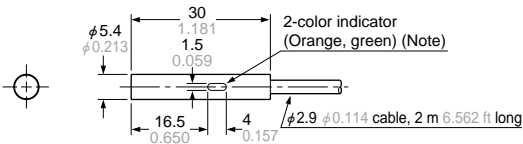

Note: Normally closed type has an operation indicator (orange) instead of the 2-color indicator.

GX-8MU GX-8MUB Sensor

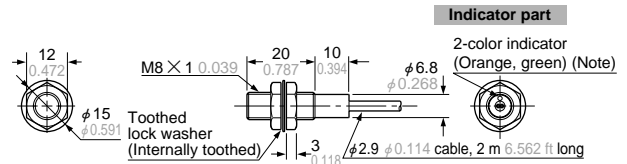

Note: Normally closed type has an operation indicator (orange) instead of the 2-color indicator.

GX-12MU GX-12MUB Sensor

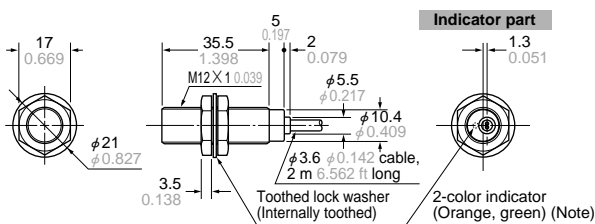

Note: Normally closed type has an operation indicator (orange) instead of the 2-color indicator.

GX-18MU GX-18MUB Sensor

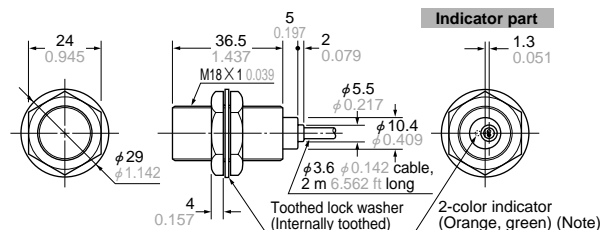

Note: Normally closed type has an operation indicator (orange) instead of the 2-color indicator.

GX-30MU GX-30MUB Sensor

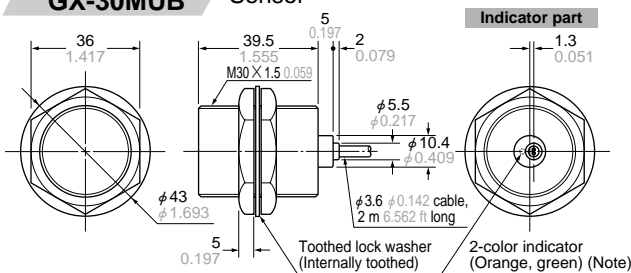

Note: Normally closed type has an operation indicator (orange) instead of the 2-color indicator.

GX-8MLU GX-8MLUB Sensor

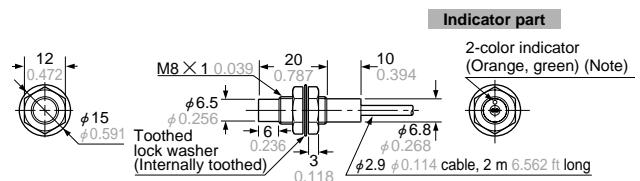

Note: Normally closed type has an operation indicator (orange) instead of the 2-color indicator.

GX-12MLU GX-12MLUB Sensor

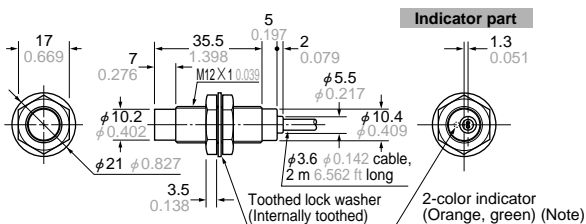

Note: Normally closed type has an operation indicator (orange) instead of the 2-color indicator.

GX-18MLU GX-18MLUB Sensor

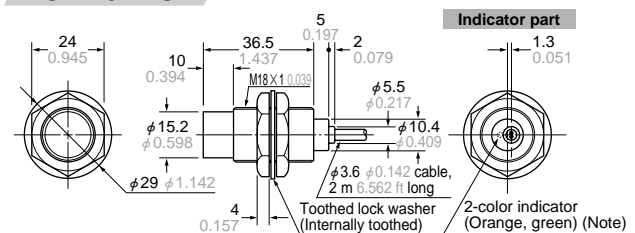

Note: Normally closed type has an operation indicator (orange) instead of the 2-color indicator.

GX-30MLU GX-30MLUB Sensor

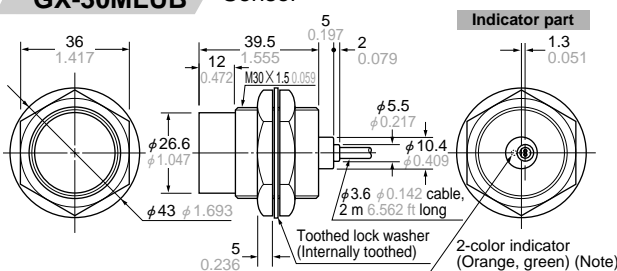

Note: Normally closed type has an operation indicator (orange) instead of the 2-color indicator.

GX-12MU-J GX-12MUB-J GX-F12MU-J Sensor

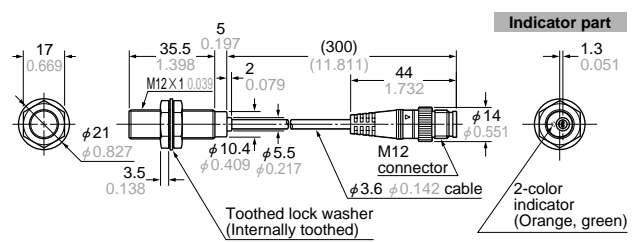

Note: Normally closed type has an operation indicator (orange) instead of the 2-color indicator.

GX-U/FU

DIMENSIONS (Unit: mm in) The CAD data in the dimensions can be downloaded from the SUNX website: <http://www.sunx.co.jp/>

GX-18MU-J GX-18MUB-J GX-F18MU-J Sensor

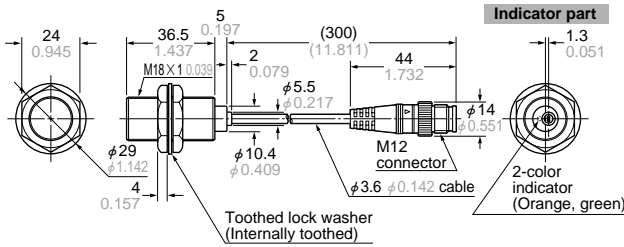

Note: Normally closed type has an operation indicator (orange) instead of the 2-color indicator.

GX-12MLU-J GX-12MLUB-J Sensor

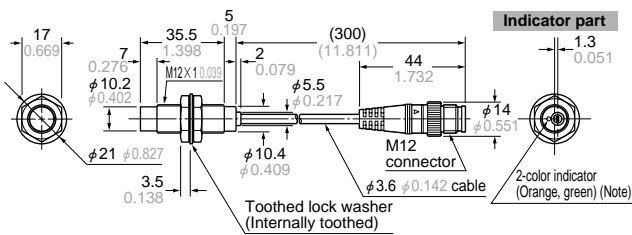

Note: Normally closed type has an operation indicator (orange) instead of the 2-color indicator.

GX-30MLU GX-30MLUB Sensor

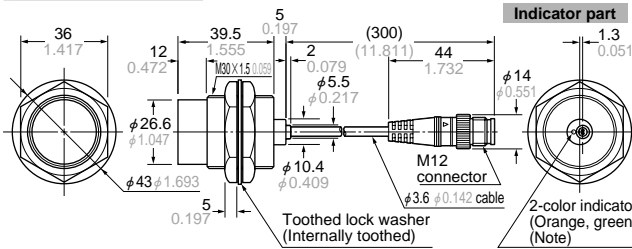

Note: Normally closed type has an operation indicator (orange) instead of the 2-color indicator.

MS-SS5 Sensor mounting bracket for GX-5SU(B) (Optional)

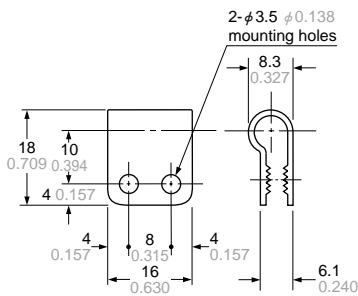

Material: Nylon 66

GX-30MU-J GX-30MUB-J GX-F30MU-J Sensor

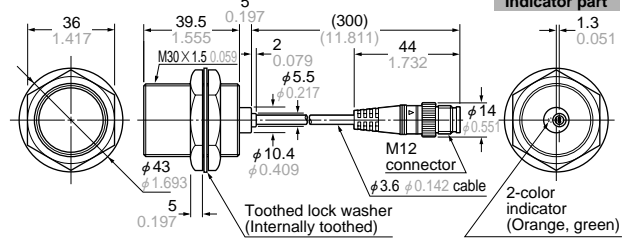

Note: Normally closed type has an operation indicator (orange) instead of the 2-color indicator.

GX-18MLU-J GX-18MLUB-J Sensor

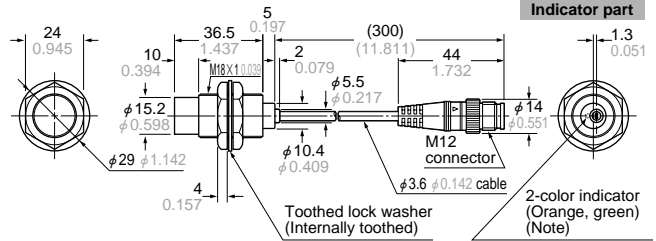

Note: Normally closed type has an operation indicator (orange) instead of the 2-color indicator.

MS-H12 MS-H18 MS-H30 Protection cover (Optional)

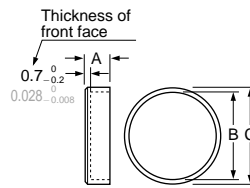

Material: Fluorine resin

| Symbol | A | B | C | Applicable model No. |
|---------------|---|-----------------|---------------|----------------------|
| Model No. | | | | |
| MS-H12 | 5 | φ11.5 φ0.453 | φ14 φ0.551 | GX-12MU(B) |
| MS-H18 | 6 | φ17.5 φ0.689 | φ20 φ0.787 | GX-18MU(B) |
| MS-H30 | 8 | φ29.4 φ1.157 | φ33 φ1.299 | GX-30MU(B) |