

阅读申明

- 1.本站收集的数据手册和产品资料都来自互联网，版权归原作者所有。如读者和版权方有任何异议请及时告之，我们将妥善解决。
- 2.本站提供的中文数据手册是英文数据手册的中文翻译，其目的是协助用户阅读，该译文无法自动跟随原稿更新，同时也可能存在翻译上的不当。建议读者以英文原稿为参考以便获得更精准的信息。
- 3.本站提供的产品资料，来自厂商的技术支持或者使用者的心得体会等，其内容可能存在描述上的差异，建议读者做出适当判断。
- 4.如需与我们联系，请发邮件到marketing@iczoom.com，主题请标有“数据手册”字样。

Read Statement

1. The datasheets and other product information on the site are all from network reference or other public materials, and the copyright belongs to the original author and original published source. If readers and copyright owners have any objections, please contact us and we will deal with it in a timely manner.
2. The Chinese datasheets provided on the website is a Chinese translation of the English datasheets. Its purpose is for reader's learning exchange only and do not involve commercial purposes. The translation cannot be automatically updated with the original manuscript, and there may also be improper translations. Readers are advised to use the English manuscript as a reference for more accurate information.
3. All product information provided on the website refer to solutions from manufacturers' technical support or users the contents may have differences in description, and readers are advised to take the original article as the standard.
4. If you have any questions, please contact us at marketing@iczoom.com and mark the subject with "Datasheets" .

Disc Type NTC Thermistors

Type: **ERTD**

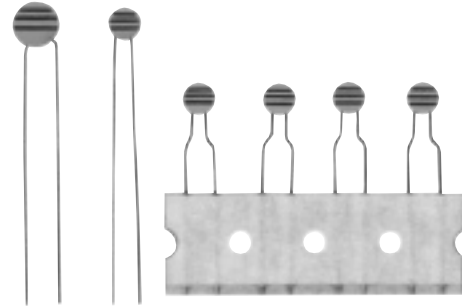

Disc type negative temperature coefficient thermistors. Resistance values from 8 Ω to 150 kΩ and B Values are from 3000 K to 5000 K.

■ Features

- Wide selection of temperature coefficients
- Excellent electrical and thermal stability

■ Recommended Applications

- Temperature detection
- Temperature compensation for measuring instruments
- Temperature compensation for deflection coil in TV

■ Explanation of Part Numbers

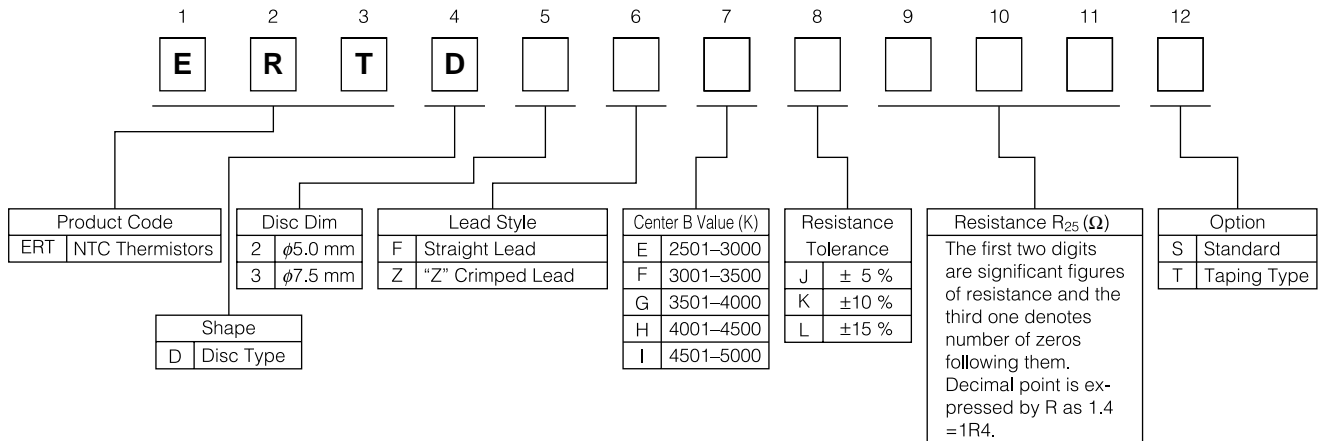

■ Derating Curve for the NTC Thermistor

For the NTC Thermistor operated in ambient temperature above 25 °C, power rating should be derated in accordance with the right figure.

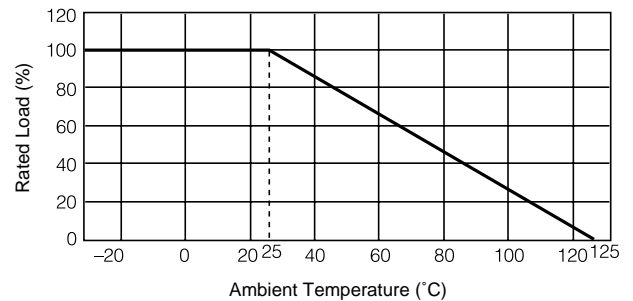

■ Ratings and Characteristics

Part No.	Zero-Power Resistance at 25 °C(Ω)	B Value** (K)	Maximum Permissible Power(W)	Heat Dissipation Constant (mW/°C)	Thermal Time Constant (s)	Resistance Ratio R ₂₅ /R ₅₀	Table A/B Curve No.
ERTD2FE□*200S	20	3000				2.18	—
ERTD2FF□*400S	40	3200				2.30	—
ERTD2FG□*750S	75	3700				2.62	1
ERTD2FF□*101S	100	3500				2.48	—
ERTD2FG□*101S	100	3700				2.62	2
ERTD2FG□*171S	170	3700				2.62	3
ERTD2FF□*251S	250	3500				2.48	—
ERTD2FG□*251S	250	3900				2.76	4
ERTD2FG□*301S	300	3900				2.76	—
ERTD2FF□*351S	350	3500				2.48	5
ERTD2FG□*601S	600	4000				2.83	6
ERTD2FG□*801S	800	3900	0.4	4.5	20	2.76	7
ERTD2FG□*102S	1000	3700				2.61	—
ERTD2FG□*142S	1400	3900				2.76	—
ERTD2FG□*202S	2000	4000				2.83	8
ERTD2FG□*332S	3300	4000				2.83	9
ERTD2FH□*462S	4600	4100				2.90	—
ERTD2FH□*802S	8000	4100				2.90	10
ERTD2FH□*103S	10000	4100				2.90	—
ERTD2FH□*153S	15000	4200				2.98	11
ERTD2FH□*333S	33000	4500				3.22	12
ERTD2FH□*503S	50000	4500				3.22	13
ERTD2FI□*154S	150000	4800				3.48	14
ERTD3FE□*8R0S	8	3000				2.18	15
ERTD3FF□*130S	13	3200				2.30	16
ERTD3FF□*160S	16	3200				2.30	—
ERTD3FF□*200S	20	3200				2.30	—
ERTD3FF□*300S	30	3200				2.30	—
ERTD3FF□*400S	40	3200				2.30	—
ERTD3FG□*750S	75	3700	0.6	7.0	27	2.62	—
ERTD3FG□*800S	80	3700				2.62	—
ERTD3FG□*131S	130	3700				2.62	—
ERTD3FG□*501S	500	4000				2.83	—
ERTD3FH□*402S	4000	4100				2.90	—
ERTD3FH□*203S	20000	4500				3.22	—
ERTD3FI□*803S	80000	5000				3.70	17

*Resistance Tolerance Code

J	K	L
±5 %	±10 %	±15 %

● Operating Temperature Range: -30 to +125 °C

**Tolerance of "B value": ±10 %

$$B = \frac{\ln(R_{25}/R_{50})}{1/298.15 - 1/323.15}$$

R₂₅=Resistance at 25.0 °C
R₅₀=Resistance at 50.0 °C

■ Dimensions in mm (not to scale)

Straight Lead Type
F Type

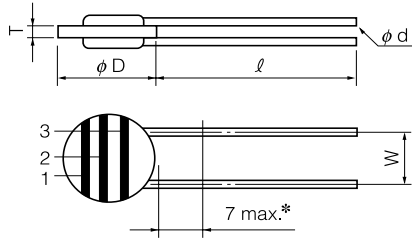

*Coating extension on leads

Crimped Lead Type
Z Type

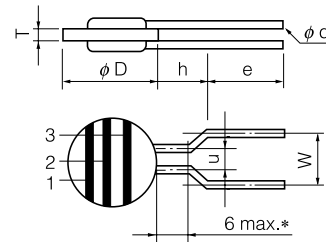

F Type

	ϕD	T	ℓ	W	ϕd
D2	5.0 ± 0.5	1.3 ± 0.5	30.0 min.	2.5 ± 1.0	0.4
D3	7.5 ± 0.5	1.4 ± 0.5	30.0 min.	5.0 ± 1.0	0.5

Z Type

	ϕD	T	u	e	h	W	ϕd
D2	5.0 ± 0.5	1.3 ± 0.5	3.0 max. (nom.2.5)	4.5 ± 1.0	6.0 max. (nom.5.0)	5.0 ± 1.0	0.5

■ Resistance vs. Temperature (Table A)

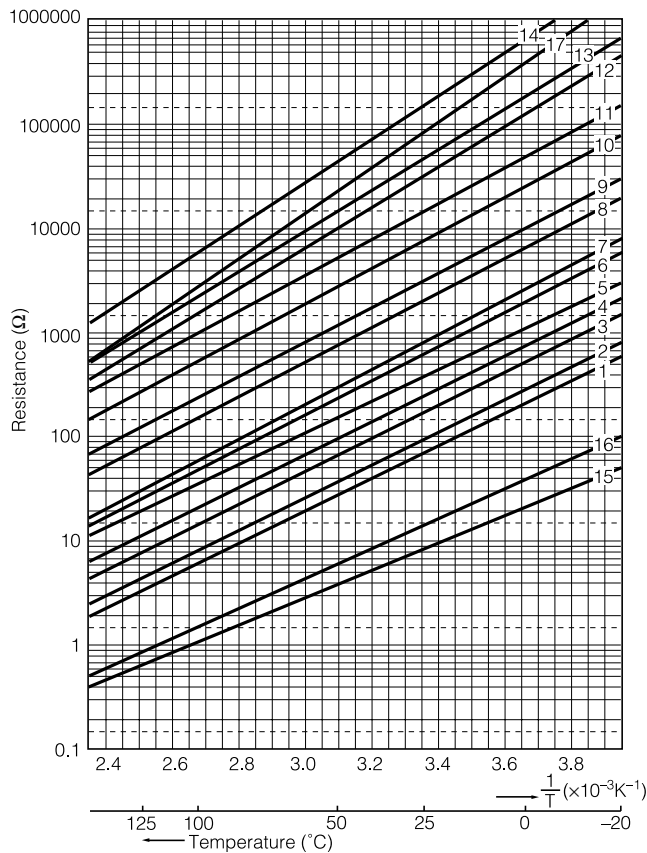

■ Voltage vs. Current (Table B)

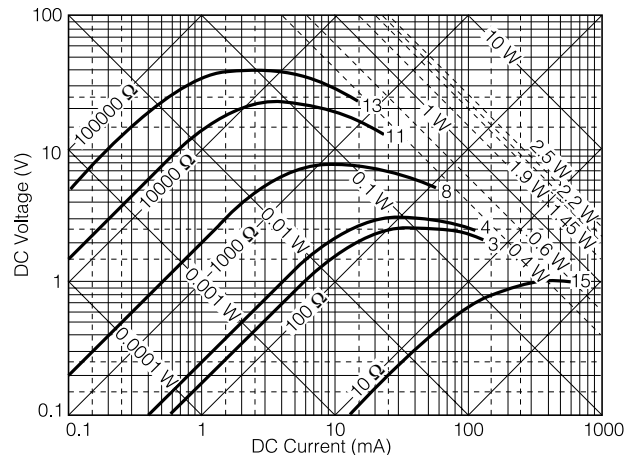

■ Resistance Color Code

Color	Code	1(1st Digit)	2(2nd Digit)	3(Multiplier)
Black		0	0	10^0
Brown		1	1	10^1
Red		2	2	10^2
Orange		3	3	10^3
Yellow		4	4	10^4
Green		5	5	10^5
Blue		6	6	10^6
Purple		7	7	10^7
Gray		8	8	10^8
White		9	9	10^9
Gold		—	—	10^{-1}
Silver		—	—	10^{-2}

■ Taping Dimensions in mm (not to scale)

Taping Type

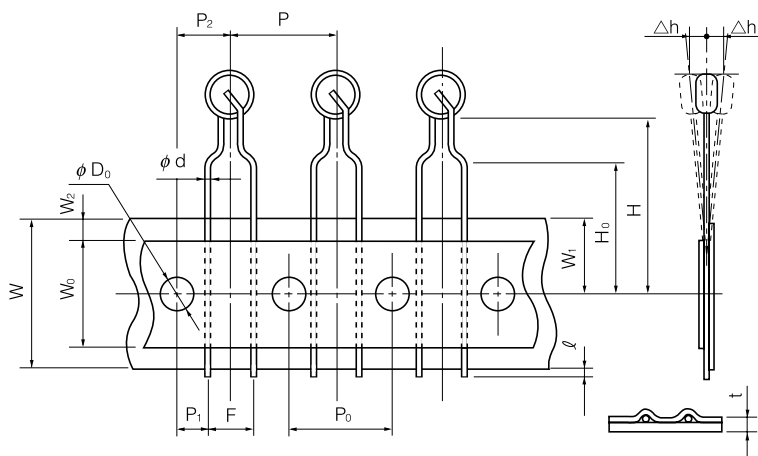

P	12.7 ± 1.0
P_0	12.7 ± 0.3
P_1	3.85 ± 0.70
P_2	6.35 ± 1.30
ϕd	0.50 ± 0.05
F	5.0 ± 1.0
Δh	0 ± 5.0
W	$18.0^{+1.0}_{-0.5}$
W_0	12.5 min.
W_1	$9.00^{+0.75}_{-0.50}$
W_2	3.0 max
H	21.0 ± 2.0
H_0	16.0 ± 0.5
l	2.0 max.
ϕD_0	4.0 ± 0.3
t	0.5 ± 0.2

Disc Type NTC Thermistors

Handling Precautions

⚠ Safety Precautions

The Disc Type NTC Thermistors (hereafter referred to as “The NTC Thermistors”) may fail in burnout, flaming or glowing in the worst case, when subjected to severe conditions of electrical, environmental and/or mechanical stresses.

The following “⚠ Safety Precautions” and “Application Notes” should be taken into consideration. For any questions regarding the “Handling Precautions”, please contact our engineering section or factory.

1. ⚠ Precautions for Safety

1.1 Operating Power

The NTC Thermistors should not be operated beyond their specified Maximum Permissible Power in the Catalog or the Individual Specifications, otherwise, burnout or damages due to the thermal run away could result. (if operated in ambient temperature above 25 °C, power rating should be derated in accordance with the derating curve.)

1.2 Operating Temperature Range

The NTC Thermistors should not be operated beyond their specified Operating Temperature Range of in the Catalog or the Individual Specifications.

(Do not touch the heated part of the NTC Thermistors by hand during operation)

1.3 Plastic Molding and Potting

In case of plastic molding or potting, the NTC Thermistors may be damaged or deteriorated by extreme mechanical stresses such as expanding and shrinking forces caused by the heat treatment of the plastics applied (depending on curing conditions and types of plastics)

1.4 Environmental Conditions

The NTC Thermistors should not be operated and/or stored under the following environmental conditions;

- a) Direct exposure to water or drops of water.
- b) Direct exposure to sunlight.
- c) Under conditions of high humidity or water condensation.
- d) Direct exposure to oil, gasoline or organic solvent and/or atmospheres of them.
- e) Under conditions of deoxidized or corrosive atmospheres such as chlorine, hydrogen sulfide, sulfur oxide or vinyl chloride.
- f) Under severe conditions of extreme vibration or shock.

1.5 Mounting

Do not let other parts touch the Thermistors because other coating is not a generated insulator.

1.6 Fail-Safe Design for Equipment

In application of the Thermistors, equipment should be protected against deterioration and failures of the Thermistors.

2. Application Notes

2.1 Soldering Flux

Rosin-based and non-activated type soldering flux is recommended.

2.2 Post Soldering Cleaning

In case of solvent cleaning, outer coating material of the NTC Thermistors may acquire the solvent, depending on the cleaning condition and type of cleaning solvent.

2.3 Abnormal Mechanical Stresses

The NTC Thermistors may be damaged or deteriorated, when dropped or exposed to a large impact. Excessive shock and impact should not be applied.

2.4 Soldering

- (1) When soldering the thermistor, solder for as short time as possible to minimize the exposure time of the element to the melting point of solder.

Take into account the solder-heat resistance of the product before use.

- (2) In soldering the device, the body and outer coating section should not be touched by molten solder and/or heated iron tip.

2.5 Long Term Storage

- (1) NTC Thermistors should not be stored under severe conditions of high temperature and/or high humidity.
- (2) NTC Thermistors should not be stored under conditions of corrosive atmospheres such as hydrogen sulfide, sulfur oxide, chlorine, and ammonia etc.
- (3) NTC Thermistors should not be exposed to direct sunlight.
- (4) NTC Thermistors should not be stored under conditions of condensation.
- (5) Store them indoors under 40 °C max. and 75 %RH max.

Use them within one year of manufacture and check the solderability before use.