

阅读申明

- 1.本站收集的数据手册和产品资料都来自互联网，版权归原作者所有。如读者和版权方有任何异议请及时告之，我们将妥善解决。
- 2.本站提供的中文数据手册是英文数据手册的中文翻译，其目的是协助用户阅读，该译文无法自动跟随原稿更新，同时也可能存在翻译上的不当。建议读者以英文原稿为参考以便获得更精准的信息。
- 3.本站提供的产品资料，来自厂商的技术支持或者使用者的心得体会等，其内容可能存在描述上的差异，建议读者做出适当判断。
- 4.如需与我们联系，请发邮件到marketing@iczoom.com，主题请标有“数据手册”字样。

Read Statement

1. The datasheets and other product information on the site are all from network reference or other public materials, and the copyright belongs to the original author and original published source. If readers and copyright owners have any objections, please contact us and we will deal with it in a timely manner.
2. The Chinese datasheets provided on the website is a Chinese translation of the English datasheets. Its purpose is for reader's learning exchange only and do not involve commercial purposes. The translation cannot be automatically updated with the original manuscript, and there may also be improper translations. Readers are advised to use the English manuscript as a reference for more accurate information.
3. All product information provided on the website refer to solutions from manufacturers' technical support or users the contents may have differences in description, and readers are advised to take the original article as the standard.
4. If you have any questions, please contact us at marketing@iczoom.com and mark the subject with "Datasheets" .

LAMINATED TRANSFORMERS

Type EE20 / 10 - 0.50VA

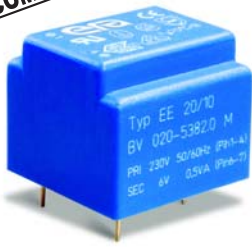







AGENCY APPROVALS 

1. UL 506, File E113449 

2. UL 1585, File E175197 [Class 2/3]

3. EN61558  

-  Frequency 50/60Hz
-  Potted under vacuum
-  Split-bobbin
-  Temperature class ta 70°C/B
-  Short-circuit-proof (where noted: 1/2/3* under Agency Approvals)
-  Weight: 0.035kg
-  Packaging unit: 40 pieces (tray)

Mechanical

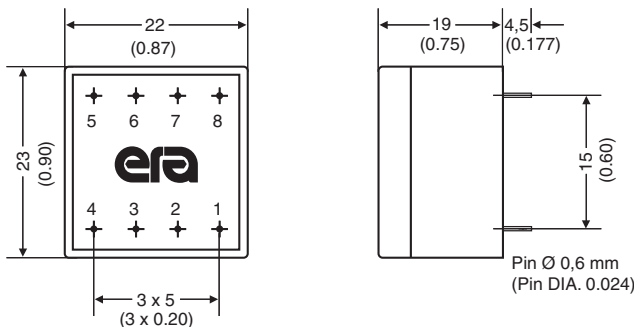

Primary (V)	Secondary (V / mA)	No-Load Voltage (V)	Schematic No.	Part Number	Agency Approvals
230	6 / 83	8.90	1	020-5382.0	1/2/3*
230	9 / 55	13.50	1	020-5383.0	1/2/3*
230	12 / 42	19.40	1	020-5384.0	1/2/3*
230	15 / 34	24.60	1	020-5385.0	1/2/3*
230	18 / 28	29.50	1	020-5386.0	1/2/3*
230	24 / 21	39.60	1	020-5387.0	1/2/3*
230	2x6 / 42	2x9.60	2	020-5388.0	1/2/3*
230	2x9 / 28	2x15.20	2	020-5389.0	1/2/3*
230	2x12 / 21	2x19.10	2	020-5390.0	1/2/3*
230	2x15 / 16	2x23.30	2	020-5391.0	1/2/3*
230	2x18 / 14	2x29.2	2	020-5392.0	1
230	2x24 / 10	2x38.8	2	020-5393.0	1
115	6 / 83	8.90	1	020-5370.0	1/2/3*
115	9 / 55	13.50	1	020-5371.0	1/2/3*
115	12 / 42	19.40	1	020-5372.0	1/2/3*
115	15 / 34	24.60	1	020-5373.0	1/2/3*
115	18 / 28	29.50	1	020-5374.0	1/2/3*
115	24 / 21	39.60	1	020-5375.0	1/2/3*
115	2x6 / 42	2x9.60	2	020-5376.0	1/2/3*
115	2x9 / 28	2x15.20	2	020-5377.0	1/2/3*
115	2x12 / 21	2x19.10	2	020-5378.0	1/2/3*
115	2x15 / 16	2x23.30	2	020-5379.0	1/2/3*
115	2x18 / 14	2x29.20	2	020-5380.0	1
115	2x24 / 10	2x38.80	2	020-5381.0	1

***NOTE:** When checking the approval status of this product with VDE, add the prefix "BV" and the suffix "M" to the orderable Part Number (these letters will also be found on the part label). **The prefix and suffix are not part of the orderable Part Number.**

Schematics

