

## 阅读申明

- 1.本站收集的数据手册和产品资料都来自互联网，版权归原作者所有。如读者和版权方有任何异议请及时告之，我们将妥善解决。
- 2.本站提供的中文数据手册是英文数据手册的中文翻译，其目的是协助用户阅读，该译文无法自动跟随原稿更新，同时也可能存在翻译上的不当。建议读者以英文原稿为参考以便获得更精准的信息。
- 3.本站提供的产品资料，来自厂商的技术支持或者使用者的心得体会等，其内容可能存在描述上的差异，建议读者做出适当判断。
- 4.如需与我们联系，请发邮件到marketing@iczoom.com，主题请标有“数据手册”字样。

## Read Statement

1. The datasheets and other product information on the site are all from network reference or other public materials, and the copyright belongs to the original author and original published source. If readers and copyright owners have any objections, please contact us and we will deal with it in a timely manner.
2. The Chinese datasheets provided on the website is a Chinese translation of the English datasheets. Its purpose is for reader's learning exchange only and do not involve commercial purposes. The translation cannot be automatically updated with the original manuscript, and there may also be improper translations. Readers are advised to use the English manuscript as a reference for more accurate information.
3. All product information provided on the website refer to solutions from manufacturers' technical support or users the contents may have differences in description, and readers are advised to take the original article as the standard.
4. If you have any questions, please contact us at marketing@iczoom.com and mark the subject with "Datasheets" .

# POWER OVER ETHERNET (PoE) MAGNETICS

## 10/100BASE-TX VoIP Magnetics Modules

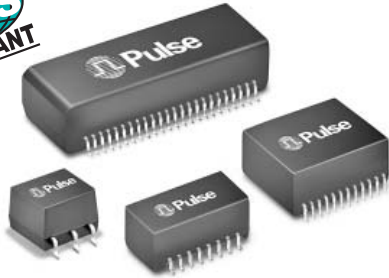

- RoHS peak reflow temperature rating 245°C
- IEEE 802.3af/ANSI X3.263 compliant performance
- Designed for IP phone or switch applications

### Electrical Specifications @ 25°C — Operating Temperature 0°C to 70°C

Part Number	Ports	Insertion Loss (dB MAX)	Return Loss (dB MIN @ 100 Ω)					Differential to Common Mode Rejection (dB MIN)			Cross Talk (dB MIN)			Hipot (Vrms MIN))	DC Resistance Balance ≤ (%)
			1-100 MHz	1-30 MHz	40 MHz	50 MHz	60-80 MHz	30 MHz	60 MHz	100 MHz	30 MHz	60 MHz	100 MHz		
H1187NL <sup>2a</sup>	1	-1.2	-16	-14	-13	-12	-43	-37	-33	-45	-40	-35	1500	—	
H1197NL <sup>2a</sup>	1	-1.2	-16	-14	-13	-12	-43	-37	-33	-45	-40	-35	1500	—	
H2019NL <sup>2a</sup>	1	-1.2	-16	-14	-13	-12	-43	-37	-33	-45	-40	-35	1500	3.5	
H2005ANL <sup>2c</sup>	2	-1.2	-16	-14	-13	-12	-50	-43	-35	-43	-37	-33	1500	3.5	
H2006ANL <sup>2c</sup>	2	-1.2	-16	-14	-13	-12	-43	-37	-33	-43	-37	-31	1500	3.5	
H2008NL <sup>2c</sup>	2	-1.2	-16	-14	-13	-12	-40	-35	-30	-43	-37	-33	1500	3.5	
H2009NL <sup>2a</sup>	2	-1.1	-16	-14	-13	-12	-43	-37	-33	-43	-37	-33	1500	3.5	
H2014NL <sup>2d</sup>	4	-1.2	-16	-14	-13	-12	-43	-37	-33	-45	-40	-35	1500	3.5	
H2017NL <sup>2c</sup>	4	-1.2	-16	-14	-13	-12	-43	-37	-33	-45	-40	-35	1800	3.5	
HX2019NL <sup>1,2a</sup>	1	-1.4	-16	-14	-13	-12	-43	-37	-33	-45	-40	-35	1500	3.5	

1. **Extended** operating temperature (-40°C to +85°C)
2. **MSL** (Moisture Sensitivity Level): a = 1, b = 2, c = 3, d = 4, e = 5

**NOTE:** When ordering Tape & Reel packaging, add the suffix "T" to the end of the part number. For example: H2008NLT.

## Mechanics

### H1187NL

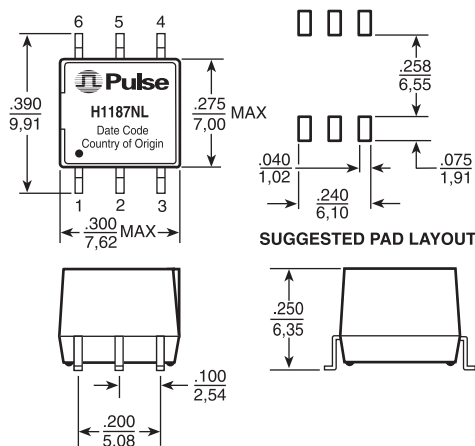

Weight . . . . . 0.6 grams  
Tape & Reel . . . . . 500/reel  
Tube . . . . . 70/tube

Dimensions:  $\frac{\text{Inches}}{\text{mm}}$  Unless otherwise specified, all tolerances are  $\pm \frac{.010}{0.25}$

### H1197NL

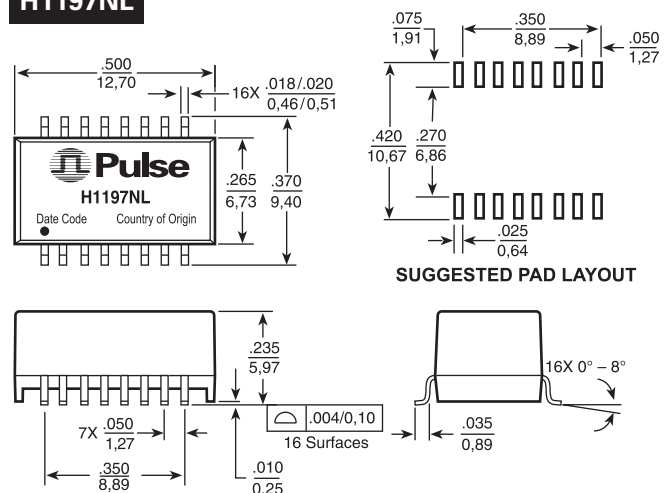

Weight . . . . . 2.8 grams  
Tape & Reel . . . . . 600/reel  
Tube . . . . . 45/tube

# POWER OVER ETHERNET (PoE) MAGNETICS

## 10/100BASE-TX VoIP Magnetics Modules



### Mechanicals

#### H2019NL, HX2019NL

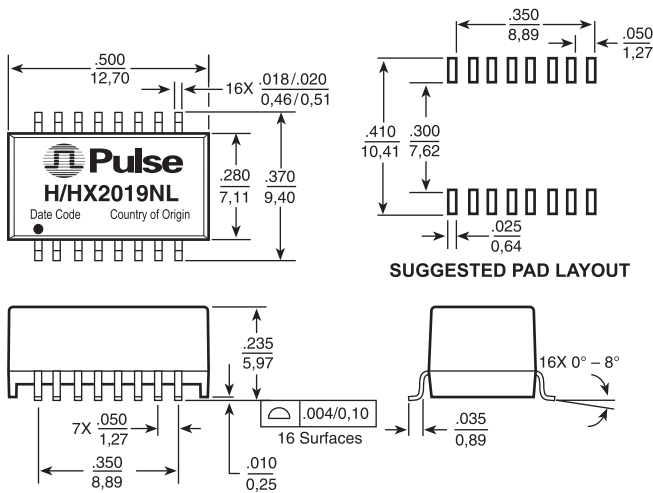

#### H2005ANL

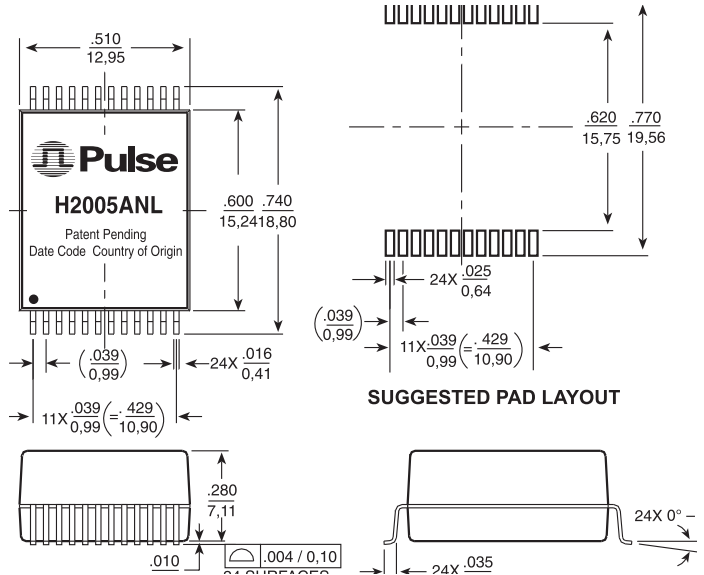

Weight . . . . . 1.0 grams  
Tape & Reel . . . . . 600/reel  
Tube . . . . . 45/tube

Dimensions:  $\frac{\text{Inches}}{\text{mm}}$  Unless otherwise specified, all tolerances are  $\pm \frac{.010}{0,25}$

Weight . . . . . 2.7 grams  
Tape & Reel . . . . . 300/reel  
Tube . . . . . 25/tube

#### H2006ANL, H2008NL

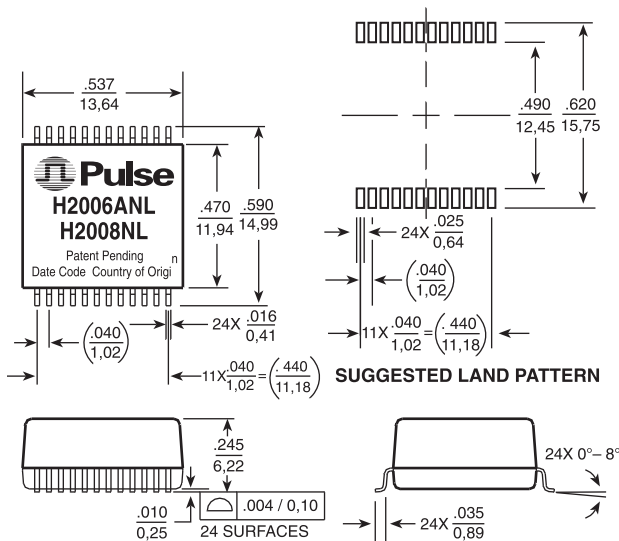

#### H2009NL

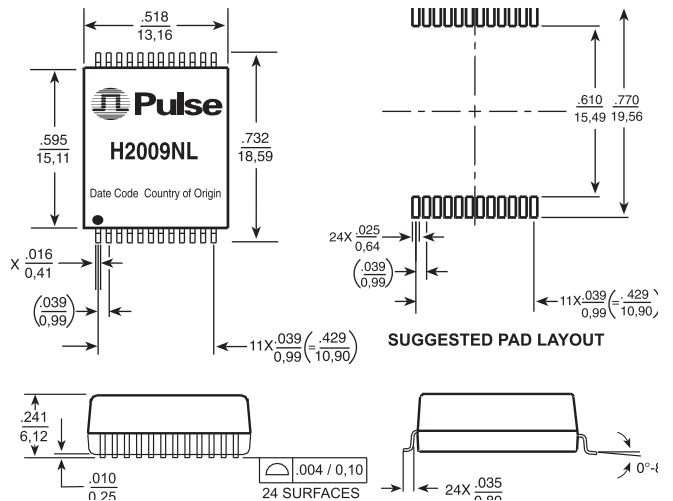

Weight . . . . . 2.4 grams  
Tape & Reel . . . . . 350/reel  
Tube . . . . . 35/tube

Dimensions:  $\frac{\text{Inches}}{\text{mm}}$  Unless otherwise specified, all tolerances are  $\pm \frac{.010}{0,25}$

Weight . . . . . 1.6 grams  
Tape & Reel . . . . . 300/reel  
Tube . . . . . 35/tube

# POWER OVER ETHERNET (PoE) MAGNETICS

## 10/100BASE-TX VoIP Magnetics Modules



### Mechanicals (continued)

#### H2014NL, H2017NL

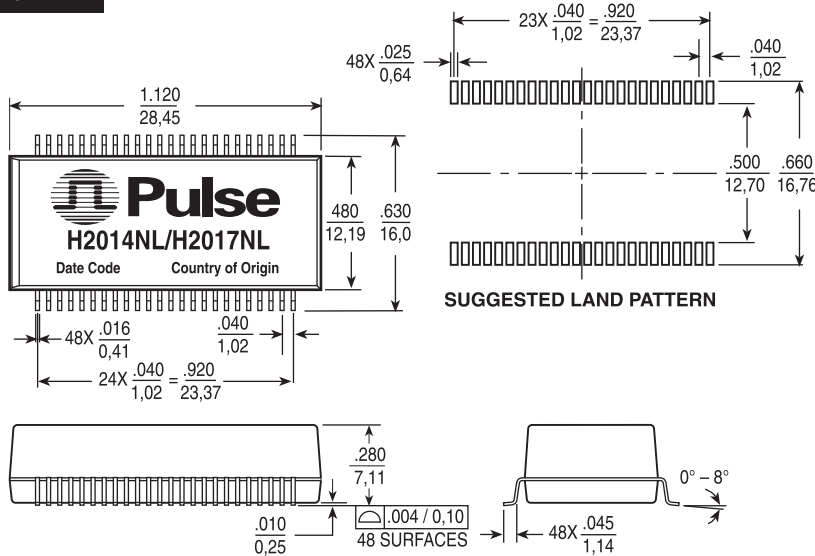

Dimensions:  $\frac{\text{Inches}}{\text{mm}}$  Unless otherwise specified, all tolerances are  $\pm \frac{.010}{0.25}$

Weight . . . . . 5.0 grams  
Tape & Reel . . . . . 250 /reel  
Tube . . . . . 15/tube

### Schematics

#### H2019NL, HX2019NL

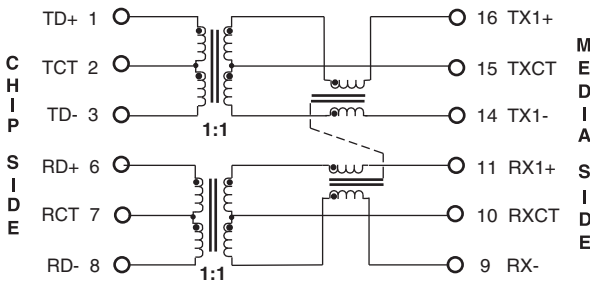

#### H1187NL

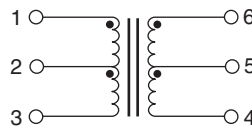

#### H1197NL

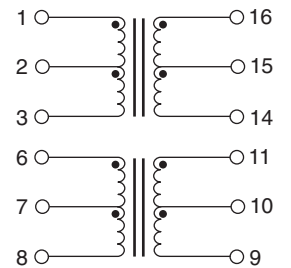

# POWER OVER ETHERNET (PoE) MAGNETICS

## 10/100BASE-TX VoIP Magnetics Modules



### Schematics (continued)

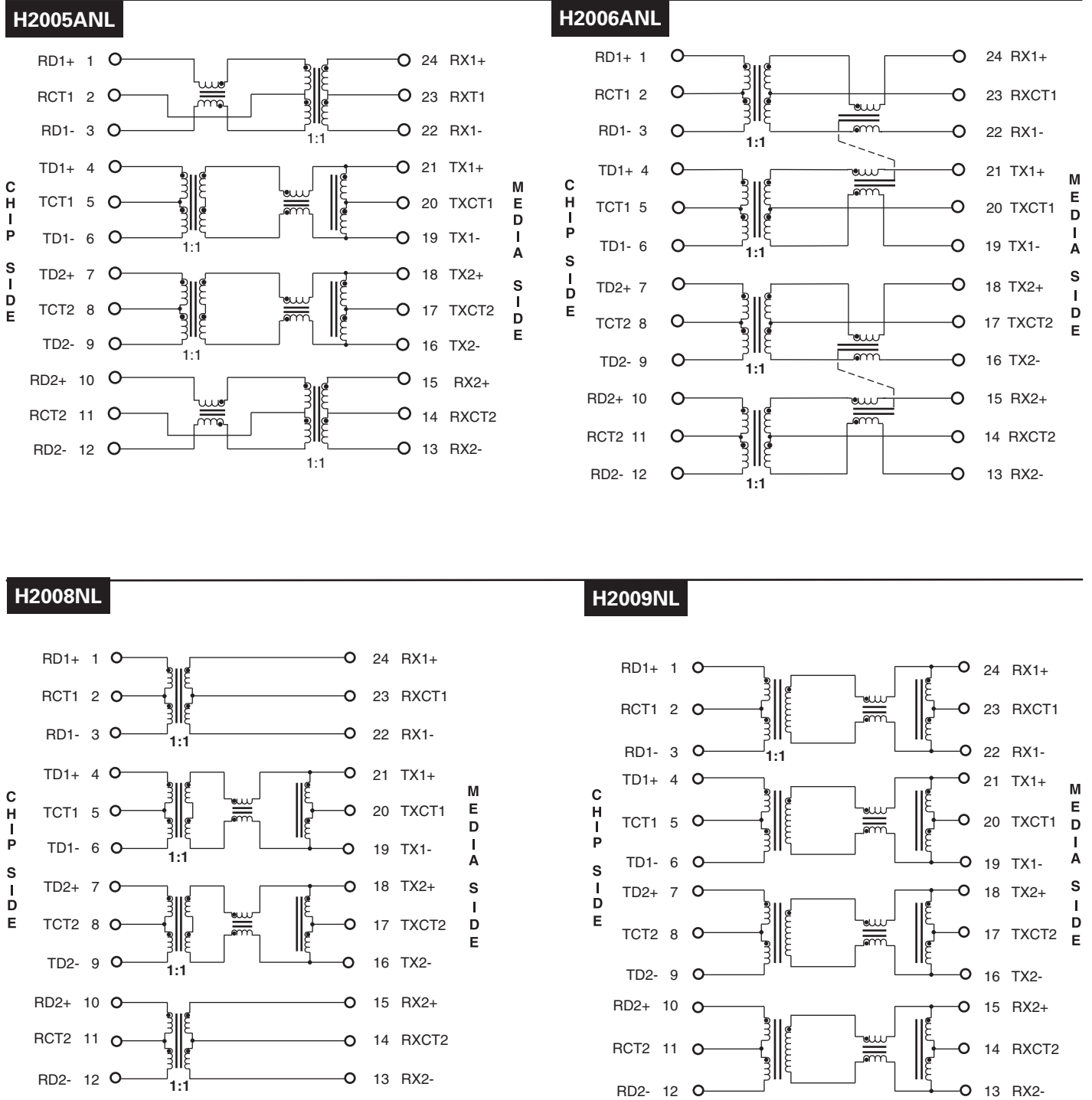

# POWER OVER ETHERNET (PoE) MAGNETICS

## 10/100BASE-TX VoIP Magnetics Modules



### Schematics (continued)

#### H2014NL

#### MEDIA SIDE

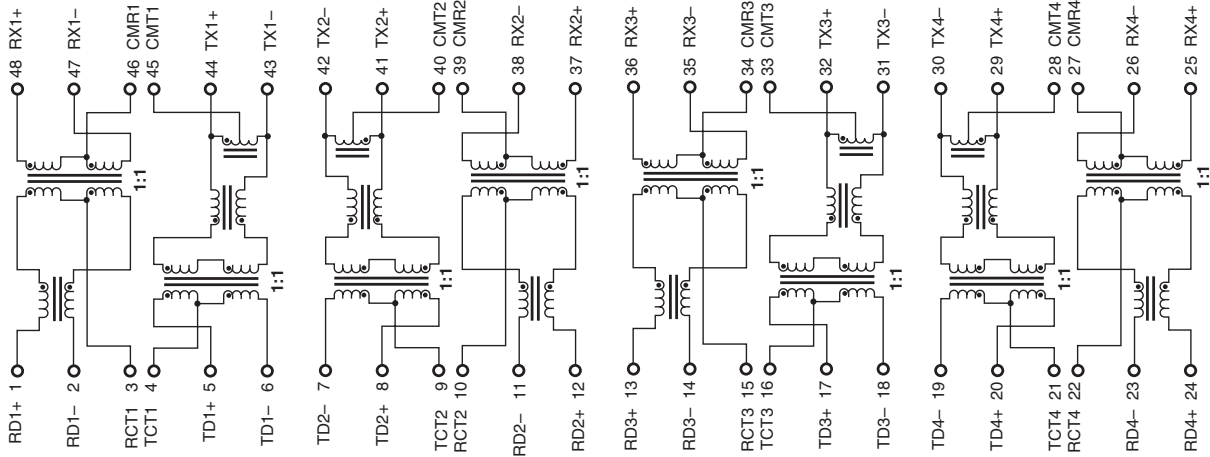

#### CHIP SIDE

#### H2017NL

#### MEDIA SIDE

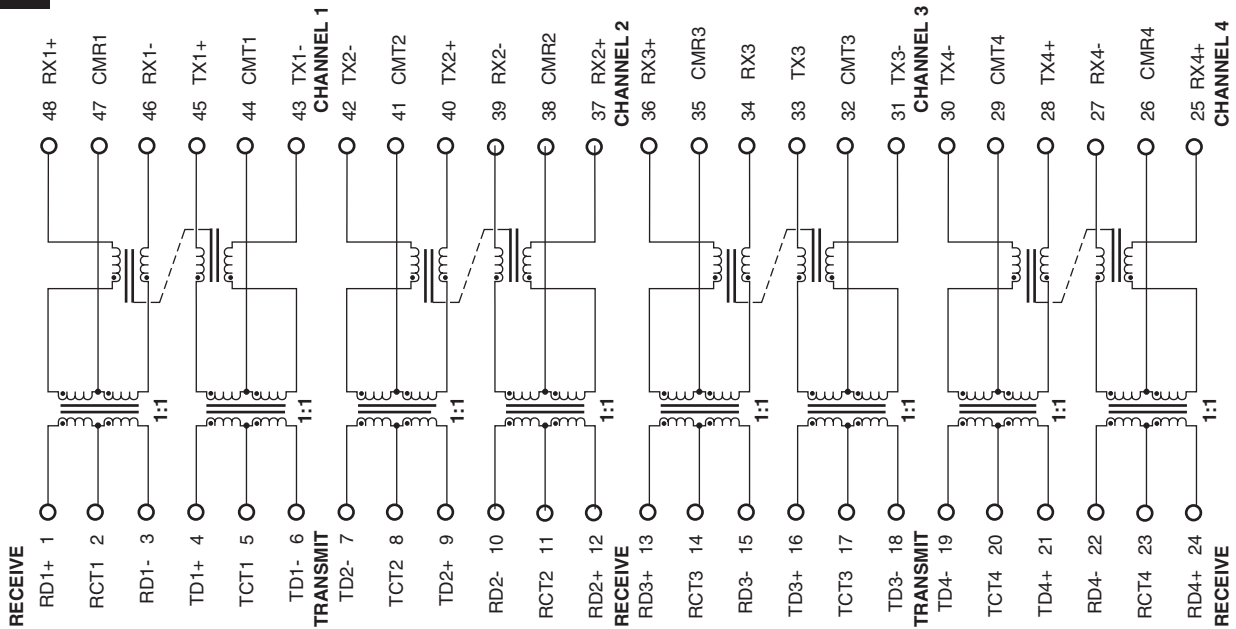

#### CHIP SIDE

### For More Information:

#### Pulse Worldwide Headquarters

12220 World Trade Dr.  
San Diego, CA 92128  
U.S.A.

#### Pulse Europe

Einsteinstrasse 1  
D-71083 Herrenberg  
Germany

#### Pulse China Headquarters

B402, Shenzhen Academy of  
Aerospace Technology Bldg.  
10th Kejinan Rd.  
High-Tech Zone  
Nanshan District  
Shenzhen, PR China 518057

#### Pulse North China

Room 1503  
XinYin Building  
No. 888 YiShan Rd.  
Shanghai 200233  
China

#### Pulse South Asia

135 Joo Seng Rd.  
#03-02  
PM Industrial Bldg.  
Singapore 368363

#### Pulse North Asia

No. 26, Kao Ching Rd.  
Yang Mei Chen  
Taoyuan Hsien  
Taiwan  
R. O. C.

#### www.pulseeng.com

Tel: 858 674 8100  
Fax: 858 674 8262

Tel: 49 7032 7806 0  
Fax: 49 7032 7806 135

TEL: 86 755 33966678  
FAX: 86 755 33966700

Tel: 86 21 54643211/2  
Fax: 86 21 54643210

TEL: 65 6287 8998  
FAX: 65 6280 0080

Tel: 886 3 4643715  
Fax: 886 3 4641911

Performance warranty of products offered on this data sheet is limited to the parameters specified. Data is subject to change without notice. Other brand and product names mentioned herein may be trademarks or registered trademarks of their respective owners.

© Copyright, 2009. Pulse Engineering, Inc. All rights reserved.