

阅读申明

- 1.本站收集的数据手册和产品资料都来自互联网，版权归原作者所有。如读者和版权方有任何异议请及时告之，我们将妥善解决。
- 2.本站提供的中文数据手册是英文数据手册的中文翻译，其目的是协助用户阅读，该译文无法自动跟随原稿更新，同时也可能存在翻译上的不当。建议读者以英文原稿为参考以便获得更精准的信息。
- 3.本站提供的产品资料，来自厂商的技术支持或者使用者的心得体会等，其内容可能存在描述上的差异，建议读者做出适当判断。
- 4.如需与我们联系，请发邮件到marketing@iczoom.com，主题请标有“数据手册”字样。

Read Statement

1. The datasheets and other product information on the site are all from network reference or other public materials, and the copyright belongs to the original author and original published source. If readers and copyright owners have any objections, please contact us and we will deal with it in a timely manner.
2. The Chinese datasheets provided on the website is a Chinese translation of the English datasheets. Its purpose is for reader's learning exchange only and do not involve commercial purposes. The translation cannot be automatically updated with the original manuscript, and there may also be improper translations. Readers are advised to use the English manuscript as a reference for more accurate information.
3. All product information provided on the website refer to solutions from manufacturers' technical support or users the contents may have differences in description, and readers are advised to take the original article as the standard.
4. If you have any questions, please contact us at marketing@iczoom.com and mark the subject with "Datasheets" .

POWER OVER ETHERNET (PoE) MAGNETICS

10/100BASE-TX VoIP Magnetics Modules



Mechanicals

H2019NL, HX2019NL

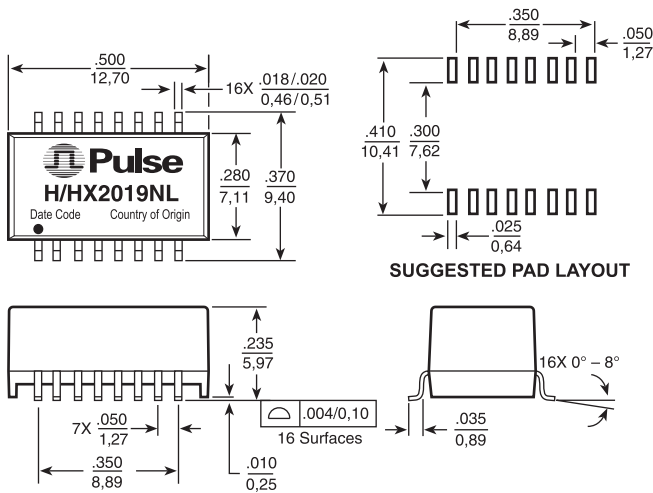

H2005ANL

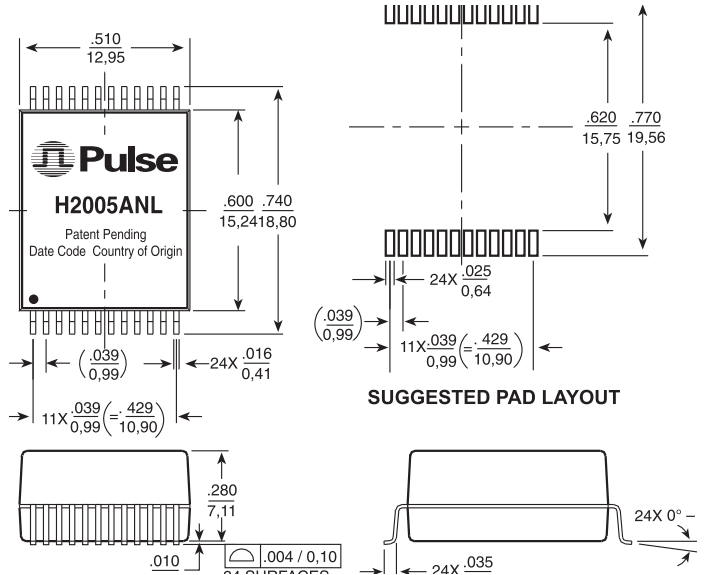

Weight 1.0 grams
Tape & Reel 600/reel
Tube 45/tube

Dimensions: $\frac{\text{Inches}}{\text{mm}}$ Unless otherwise specified, all tolerances are $\pm \frac{.010}{0,25}$

Weight 2.7 grams
Tape & Reel 300/reel
Tube 25/tube

H2006ANL, H2008NL

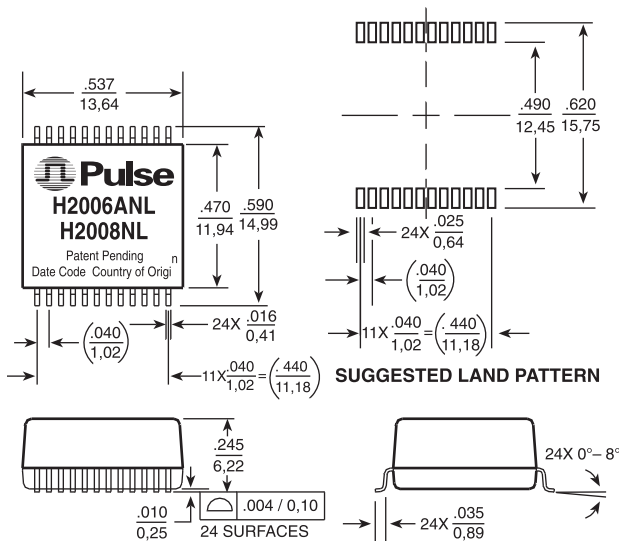

H2009NL

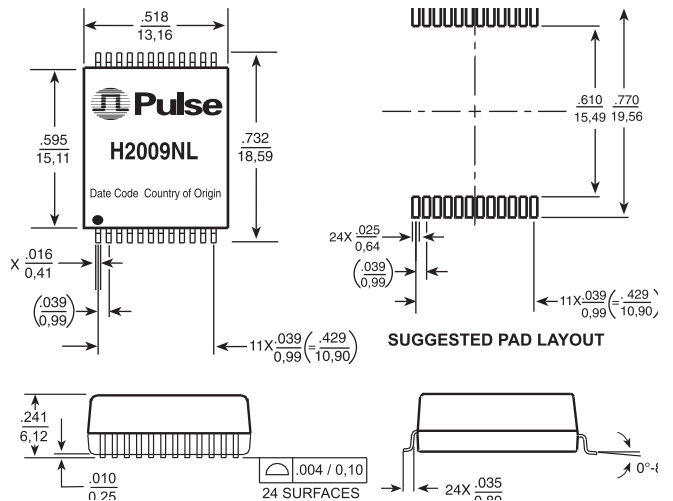

Weight 2.4 grams
Tape & Reel 350/reel
Tube 35/tube

Dimensions: $\frac{\text{Inches}}{\text{mm}}$ Unless otherwise specified, all tolerances are $\pm \frac{.010}{0,25}$

Weight 1.6 grams
Tape & Reel 300/reel
Tube 35/tube

POWER OVER ETHERNET (PoE) MAGNETICS

10/100BASE-TX VoIP Magnetics Modules



Mechanicals (continued)

H2014NL, H2017NL

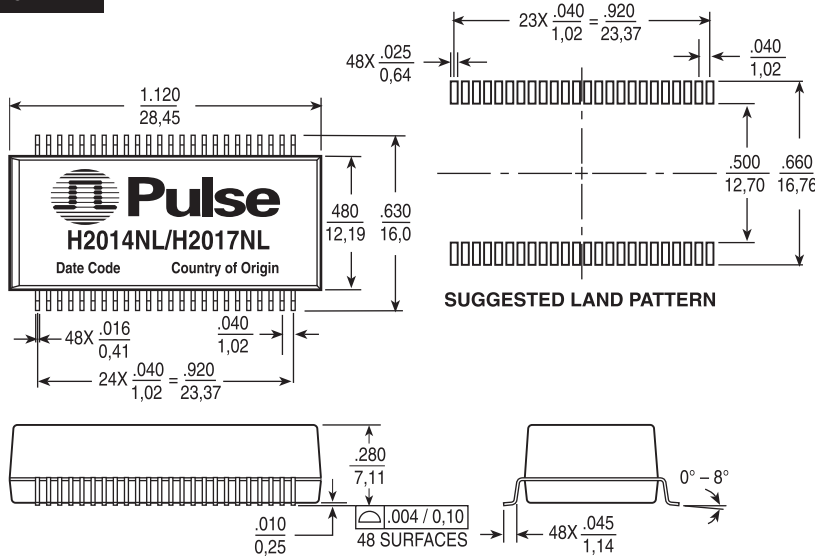

Dimensions: $\frac{\text{Inches}}{\text{mm}}$ Unless otherwise specified, all tolerances are $\pm \frac{.010}{0.25}$

Weight 5.0 grams
Tape & Reel 250 /reel
Tube 15/tube

Schematics

H2019NL, HX2019NL

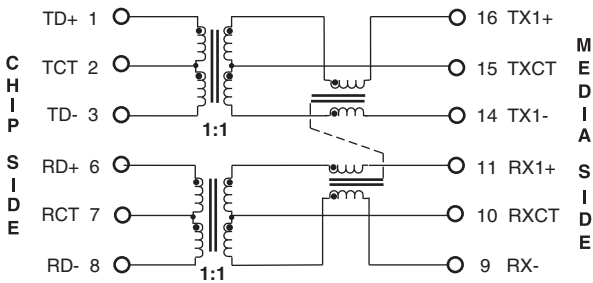

H1187NL

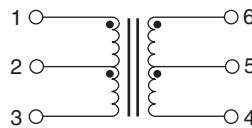

H1197NL

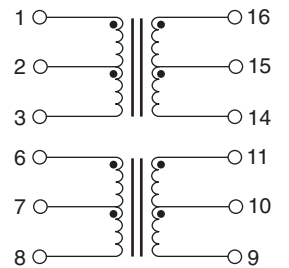

POWER OVER ETHERNET (PoE) MAGNETICS

10/100BASE-TX VoIP Magnetics Modules



Schematics (continued)

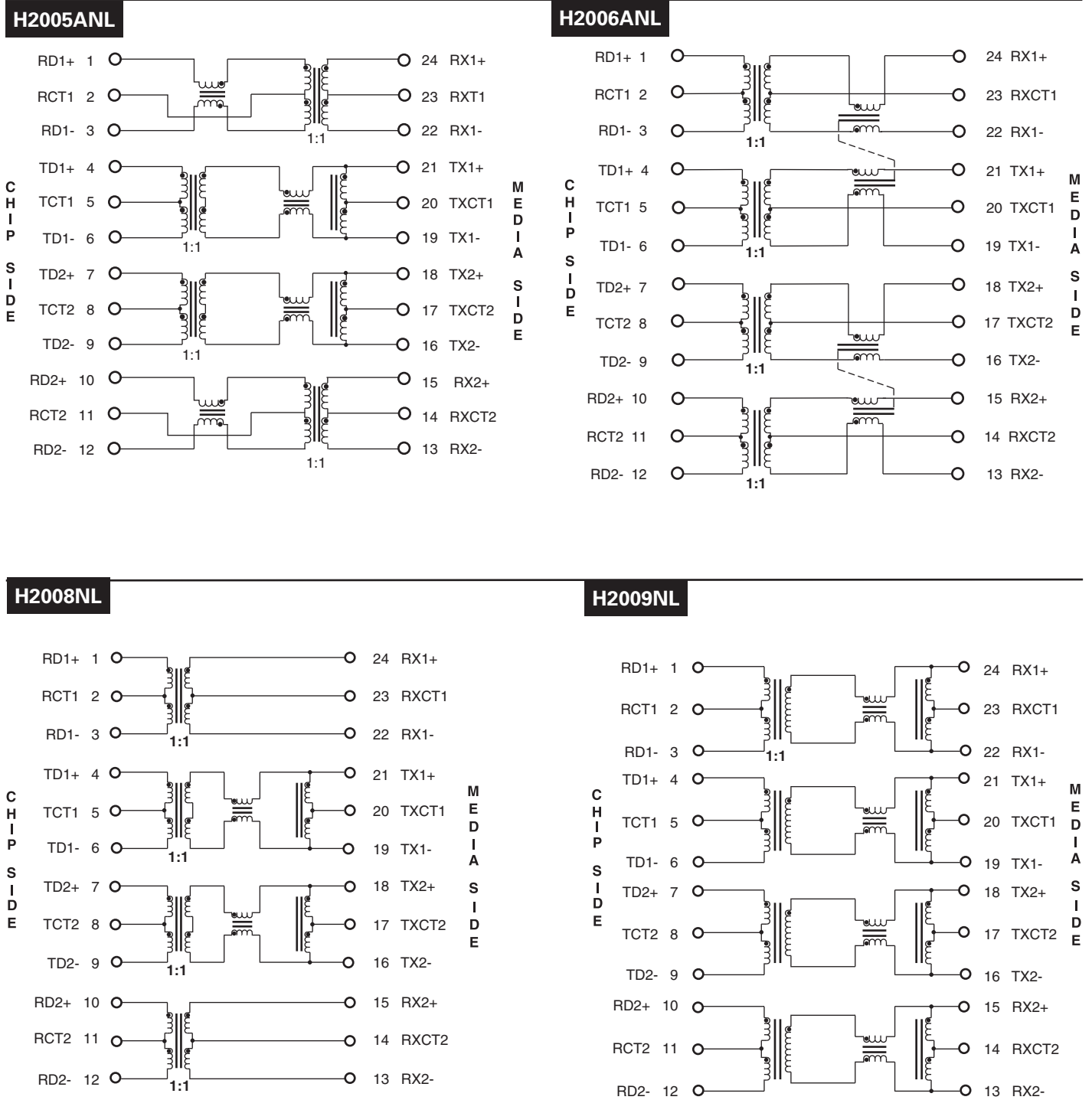

POWER OVER ETHERNET (PoE) MAGNETICS

10/100BASE-TX VoIP Magnetics Modules



Schematics (continued)

H2014NL

MEDIA SIDE

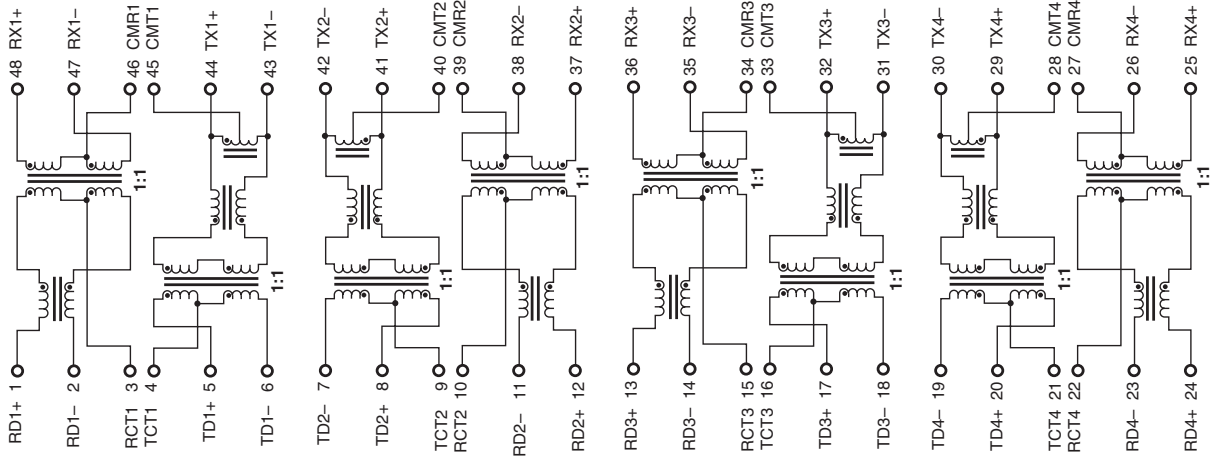

CHIP SIDE

H2017NL

MEDIA SIDE

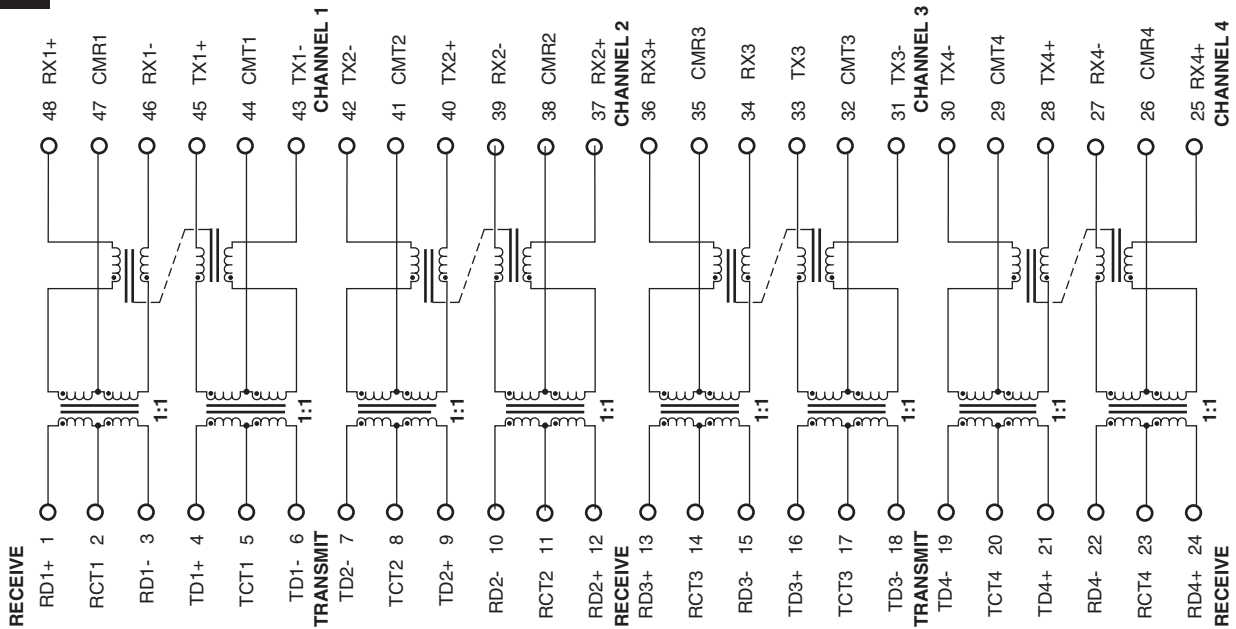

CHIP SIDE

For More Information:

Pulse Worldwide Headquarters

12220 World Trade Dr.
San Diego, CA 92128
U.S.A.

Pulse Europe

Einsteinstrasse 1
D-71083 Herrenberg
Germany

Pulse China Headquarters

B402, Shenzhen Academy of
Aerospace Technology Bldg.
10th Kejinan Rd.
High-Tech Zone
Nanshan District
Shenzhen, PR China 518057

Pulse North China

Room 1503
XinYin Building
No. 888 YiShan Rd.
Shanghai 200233
China

Pulse South Asia

135 Joo Seng Rd.
#03-02
PM Industrial Bldg.
Singapore 368363

Pulse North Asia

No. 26, Kao Ching Rd.
Yang Mei Chen
Taoyuan Hsien
Taiwan
R. O. C.

www.pulseeng.com

Tel: 858 674 8100
Fax: 858 674 8262

Tel: 49 7032 7806 0
Fax: 49 7032 7806 135

TEL: 86 755 33966678
FAX: 86 755 33966700

Tel: 86 21 54643211/2
Fax: 86 21 54643210

TEL: 65 6287 8998
FAX: 65 6280 0080

Tel: 886 3 4643715
Fax: 886 3 4641911

Performance warranty of products offered on this data sheet is limited to the parameters specified. Data is subject to change without notice. Other brand and product names mentioned herein may be trademarks or registered trademarks of their respective owners.

© Copyright, 2009. Pulse Engineering, Inc. All rights reserved.