

## 阅读申明

- 1.本站收集的数据手册和产品资料都来自互联网，版权归原作者所有。如读者和版权方有任何异议请及时告之，我们将妥善解决。
- 2.本站提供的中文数据手册是英文数据手册的中文翻译，其目的是协助用户阅读，该译文无法自动跟随原稿更新，同时也可能存在翻译上的不当。建议读者以英文原稿为参考以便获得更精准的信息。
- 3.本站提供的产品资料，来自厂商的技术支持或者使用者的心得体会等，其内容可能存在描述上的差异，建议读者做出适当判断。
- 4.如需与我们联系，请发邮件到marketing@iczoom.com，主题请标有“数据手册”字样。

## Read Statement

1. The datasheets and other product information on the site are all from network reference or other public materials, and the copyright belongs to the original author and original published source. If readers and copyright owners have any objections, please contact us and we will deal with it in a timely manner.
2. The Chinese datasheets provided on the website is a Chinese translation of the English datasheets. Its purpose is for reader's learning exchange only and do not involve commercial purposes. The translation cannot be automatically updated with the original manuscript, and there may also be improper translations. Readers are advised to use the English manuscript as a reference for more accurate information.
3. All product information provided on the website refer to solutions from manufacturers' technical support or users the contents may have differences in description, and readers are advised to take the original article as the standard.
4. If you have any questions, please contact us at marketing@iczoom.com and mark the subject with "Datasheets" .

# D-Series Circuit Breaker

Designed for snap-on-back panel rail mounting on either a 35mm x 7.5mm, or a 35mm x 15mm Symmetrical Din Rail, allowing rapid and simple mounting and removal of the breaker. It features recessed, wire-ready, touch-proof, shock-resistant terminals, suitable for automatic screwdriver assembly, as well as "Dead Front" construction characteristics.

Available with a Visi-Rocker two-color actuator, which can be specified to indicate either the ON or the TRIPPED/OFF mode, or solid color rocker or handle type actuators. All actuator types fit in the same industry standard panel cutouts.

## Features:

- 0.02 - 50 Amps
- 480 VAC or 65 VDC
- 1-4 poles (Handle)
- 1-3 poles (Rocker)
- Choice of Time Delays
- DIN rail mounting
- Precise temperature independent operation
- Wiping contacts – mechanical linkage with two-step
- Finger safe terminals
- Common trip linkage between poles – ensures that an overload in one pole will trip all adjacent poles

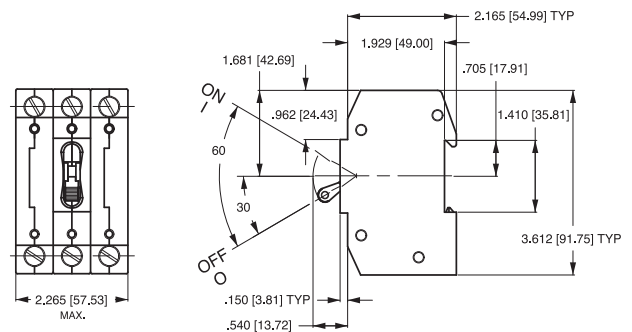
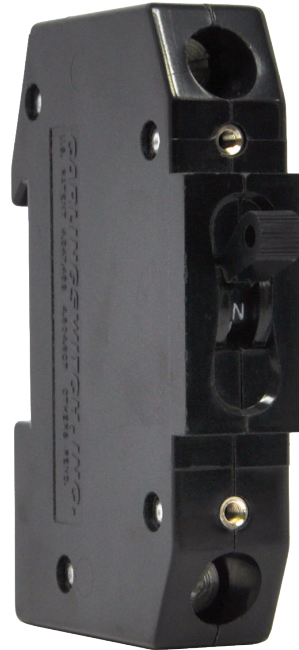

## Notes:

- 1 All dimensions are in inches [millimeters].
- 2 Tolerance  $\pm 0.020$  [.51] unless otherwise specified.



**Carling Technologies™**  
Innovative Designs. Powerful Solutions.

## Electrical

Maximum Voltage	AC, 480 wye/277 VAC (See Table A), 50/60 Hz, 65VDC
Standard Current Coils	0.100, 0.250, 0.500, 0.750, 1.00, 2.50, 5.00, 7.50, 10.0, 15.0, 20.0, 25.0, 30.0, 35.0, 40.0 & 50.0. Other ratings available - consult factory.
Standard Voltage Coils	DC - 6V, 12V; AC - 120V, other ratings available, see ordering scheme.
Insulation Resistance	Minimum of 100 Megohms at 500 VDC.
Dielectric Strength	UL, CSA: 1960 V 50/60 Hz for one minute between all electrically isolated terminals. D-Series circuit breakers comply with the 8mm spacing and 3750V 50/60 Hz dielectric requirements from hazardous voltage to operator accessible surfaces and between adjacent poles per Publications EN 60950 and VDE 0805.
Resistance, Impedance	Values from Line to Load Terminal - based on Series Trip Circuit Breaker

## Mechanical

Endurance	10,000 ON-OFF operations @ 6 per minute; with rated Current and Voltage.
Trip Free	All D-Series Circuit Breakers will trip on overload, even when actuator is forcibly held in the ON position.
Trip Indication	The operating actuator moves positively to the OFF position when an overload causes the breaker to trip.

## Physical

Number of Poles	Rocker Type: 1-3; Handle Type: 1-4
Internal Circuit Config.	Switch Only and Series Trip with current or voltage trip coils.
Weight	Approximately 128 grams/pole (Approximately 4.57 ounces/pole)
Standard Colors	Housing - Black; Actuator - See Ordering Scheme.
Mounting	Mounts on a standard 35mm Symmetrical DIN Rail (35 x 7.5 or 35 x 15mm per DIN EN5002).

## Environmental

Designed and tested in accordance with requirements of specification MIL-PRF-55629 & MIL-STD-202 as follows:

Shock	Withstands 100 Gs, 6ms, sawtooth while carrying rated current per Method 213, Test Condition "I". Instantaneous and ultra-short curves tested @ 90% of rated current.
Vibration	Withstands 0.060" excursion from 10-55 Hz, and 10 Gs 55-500 Hz, at rated current per Method 204C, Test Condition A. Instantaneous and ultra-short curves tested at 90% of rated current.
Moisture Resistance	Method 106D, i.e., ten 24-hour cycles @ + 25°C to +65°C, 80-98% RH.
Salt Spray	Method 101, Condition A (90-95% RH @ 5% NaCl Solution, 96 hrs).
Thermal Shock	Method 107D, Condition A (Five cycles @ -55°C to +25°C to +85°C to +25°C).
Operating Temperature	-40° C to +85° C

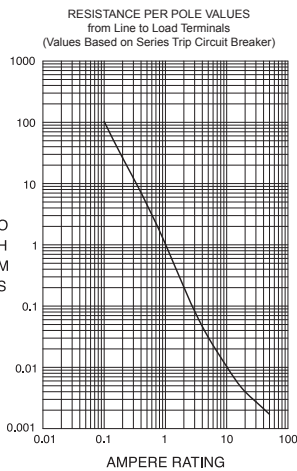

CURRENT (AMPS)	TOLERANCE (%)
0.10 - 5.0	15%
5.1 - 20.0	25%
20.1 - 50.0	35%

Pulse Tolerance Curves

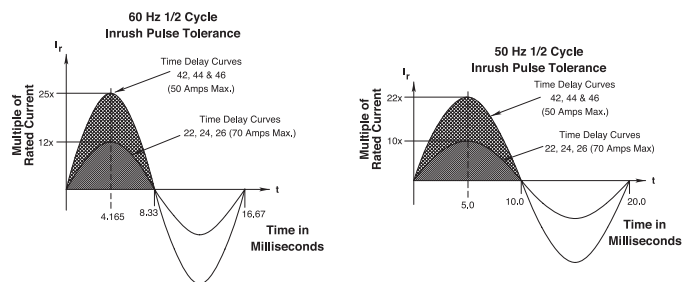

\*Manufacturer reserves the right to change product specification without prior notice.

## Electrical Tables

**Table A:** Lists UL Recognized, CSA Accepted and VDE Certified configurations and performance capabilities as a Component Supplementary Protector.

D-SERIES TABLE A: COMPONENT SUPPLEMENTARY PROTECTORS										
CIRCUIT CONFIGURATION	VOLTAGE			CURRENT RATING	SHORT CIRCUIT CAPACITY (AMPS)				APPLICATION CODES	
	MAX. RATING	FREQUENCY	PHASE <sup>1</sup>		UL/CSA		VDE		UL	CSA
				FULL LOAD AMPS	WITH BACKUP FUSE	WITH BACKUP FUSE	(Inc) WITH BACKUP FUSE	(Inc) WITHOUT BACKUP FUSE		
SERIES	65	DC	--	0.02 - 50	--	5,000	5,000	1,500	TC1,2, OL1, U1	TC1,2, OL1, U1
	80	DC	--	0.02 - 50	--	5,000	5,000	1,500	TC1,2, OL1, U1	TC1,2, OL1, U1
	125 / 250	50 / 60	1	0.02 - 50	--	3,000	--	--	TC1,2, OL1, U1	TC1,2, OL1, U1
	250	50 / 60	1 & 3	0.02 - 50	5,000 <sup>2</sup>	--	5,000	1,500	TC1,2, OL1, C1	TC1,2, OL1, C1
	277	50 / 60	1	0.02 - 50	5,000 <sup>2</sup>	--	--	--	TC1,2, OL1, C1	TC1,2, OL1, C1
	480 Y <sup>3</sup>	50 / 60	1 & 3	0.02 - 50	5,000 <sup>2</sup>	--	--	--	TC1,2, OL1, C1	TC1,2, OL1, C1
SWITCH ONLY	65	DC	--	0.02 - 50						
	250	50 / 60	3	0.02 - 50						
	277	50 / 60	1	0.02 - 50						
	480 Y <sup>3</sup>	50 / 60	1 & 3	0.02 - 30						

Table A Notes:

- DC and 1Phase 277 V ratings are 1 or 2 poles breaking. Three phase ratings are 3 poles breaking.
- Requires branch circuit backup with a UL LISTED Type K5 or RK5 fuse rated 15A minimum and no more than 4 times full load amps not to exceed 150 A for 250V rating and 125 A for 277 and 480 V ratings.
- UL recognition and CSA Acceptance at 480 volts refers to 3 and 4 pole versions, used only in a 3 phase WYE connected circuit or 2 pole versions connected with 2 poles breaking 1 phase and backed up with series fusing per note 2

## Agency Certifications

### UL Recognized

UL Standard 1077



Component Recognition Program as Protectors, Supplementary (Guide QVNU2, File E75596)

### CSA Accepted



Component Supplementary Protector under Class 3215 30, File 047848 0 000  
CSA Standard C22.2 No. 235

### UL Listed

UL Standard 508



Switches, Industrial Control (Guide NRNT2, File E148683)

### VDE Certified



EN60934, VDE 0642 under File No. 10537



**1 SERIES**  
**D**

**2 ACTUATOR<sup>1</sup>**  
**Handle<sup>2</sup>**  
**A** Handle, one per pole  
**B** Handle, one per multipole unit  
**Visi-Rocker<sup>3</sup>**  
**C** Indicate ON, vertical legend  
**D** Indicate ON, horizontal legend  
**E** Indicate ON, no legend (VDE approval not available with no legend)  
**F** Indicate OFF, vertical legend  
**G** Indicate OFF, horizontal legend  
**H** Indicate OFF, no legend (VDE approval not available with no legend)  
**Single Color Rocker<sup>3</sup>**  
**J** Vertical legend  
**K** Horizontal legend  
**L** No legend (VDE approval not available with no legend)

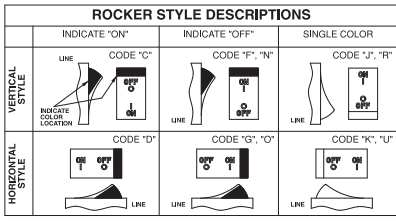

**3 POLES**  
**1** One  
**2** Two  
**3** Three  
**4** Four

**4 CIRCUIT**  
**A0** Switch Only (No Coil)<sup>4</sup>  
**B0** Series Trip (Current)  
**C0** Series Trip (Voltage)

**5 FREQUENCY & DELAY**

<b>03</b>	DC 50/60Hz, Switch Only	<b>26</b>	50/60Hz Long
<b>10<sup>5</sup></b>	DC Instantaneous	<b>32</b>	DC, 50/60Hz Short
<b>11</b>	DC Ultra Short	<b>34</b>	DC, 50/60Hz Medium
<b>12</b>	DC Short	<b>36</b>	DC, 50/60Hz Long
<b>14</b>	DC Medium	<b>42<sup>6</sup></b>	50/60Hz Short, Hi-Inrush
<b>16</b>	DC Long	<b>44<sup>6</sup></b>	50/60Hz Medium, Hi-Inrush
<b>20<sup>5</sup></b>	50/60Hz Instantaneous	<b>46<sup>6</sup></b>	50/60Hz Long, Hi-Inrush
<b>21</b>	50/60Hz Ultra Short	<b>52<sup>6</sup></b>	DC, Short, Hi-Inrush
<b>22</b>	50/60Hz Short	<b>54<sup>6</sup></b>	DC, Medium, Hi-Inrush
<b>24</b>	50/60Hz Medium	<b>56<sup>6</sup></b>	DC, Long, Hi-Inrush

Notes:  
 1 Handle breakers available up to four poles. Rocker breakers available up to three poles.  
 2 Actuator Code:  
     A: Multi-pole units factory assembled with common handle tie.  
     B: Handle location as viewed from front of breaker:  
         2 pole - left pole  
         3 pole - center pole  
         4 pole - two handles at center poles  
 3 Multipole rocker breakers have one rocker per breaker, as viewed from the front of the panel. Two pole - left pole. Three pole - center pole  
 4 ≤30A, select Current Rating code 630. 31-50A, select Current Rating code 650.  
 5 Voltage coil only available with delay codes 10 & 20.  
 6 Available to 50A max with circuit code B0 only.  
 7 Color shown is visi and legend with remainder of rocker black.  
 8 ≥300V: Three pole breaker 30 or 2 pole breaker 10, UL/CSA limited to 30 FLA max.  
 9 VDE Approval requires Dual (I-O, ON-OFF) or I-O markings

**7 CURRENT RATING (AMPERES)**

CODE	AMPERES	CODE	AMPERES	CODE	AMPERES	CODE	AMPERES
020	0.020	280	0.800	460	6.000	619	19.000
025	0.025	285	0.850	465	6.500	620	20.000
030	0.030	410	1.000	470	7.000	621	21.000
050	0.050	512	1.250	572	7.250	622	22.000
075	0.075	413	1.300	475	7.500	623	23.000
080	0.080	414	1.400	480	8.000	624	24.000
085	0.085	415	1.500	485	8.500	625	25.000
110	0.100	517	1.750	490	9.000	626	26.000
115	0.150	420	2.000	495	9.500	627	27.000
220	0.200	522	2.250	610	10.000	628	28.000
225	0.250	425	2.500	710	10.500	629	29.000
230	0.300	527	2.750	611	11.000	630	30.000
235	0.350	430	3.000	711	11.500	632	32.000
240	0.400	532	3.250	612	12.000	635	35.000
245	0.450	435	3.500	712	12.500	640	40.000
250	0.500	436	3.600	613	13.000	645	45.000
255	0.550	440	4.000	614	14.000	650	50.000
260	0.600	445	4.500	615	15.000		
265	0.650	547	4.750	616	16.000		
270	0.700	450	5.000	617	17.000		
275	0.750	455	5.500	618	18.000		

**OR VOLTAGE COIL (VOLTS, MIN. TRIP RATING)<sup>5</sup>**

<b>A06</b>	6 DC, 5 DC	<b>A48</b>	48 DC, 40 DC	<b>J24</b>	24 AC, 20 AC
<b>A12</b>	12 DC, 10 DC	<b>A65</b>	65 DC, 55 DC	<b>J48</b>	48 AC, 40 AC
<b>A18</b>	18 DC, 15 DC	<b>J06</b>	6 AC, 5 AC	<b>K20</b>	120 AC, 65 AC
<b>A24</b>	24 DC, 20 DC	<b>J12</b>	12 AC, 10 AC	<b>L40</b>	240 AC, 130 AC
<b>A32</b>	32 DC, 25 DC	<b>J18</b>	18 AC, 15 AC		

**7 TERMINAL**  
**1** #10 Screw & Pressure Plate for Direct Wire Connection  
**2** #10 Screw without Pressure Plate

**8 ACTUATOR COLOR & LEGEND**

Color	I-O	ON-OFF	Dual	Marking Color: Single Color Rocker/Handle	Visi-Rocker (Actuator Black) <sup>7</sup>
White	<b>A</b>	<b>B</b>	<b>1</b>	Black	White
Black	<b>C</b>	<b>D</b>	<b>2</b>	White	N/A
Red	<b>F</b>	<b>G</b>	<b>3</b>	White	Red
Green	<b>H</b>	<b>J</b>	<b>4</b>	White	Green
Blue	<b>K</b>	<b>L</b>	<b>5</b>	White	Blue
Yellow	<b>M</b>	<b>N</b>	<b>6</b>	Black	Yellow
Gray	<b>P</b>	<b>Q</b>	<b>7</b>	Black	Gray
Orange	<b>R</b>	<b>S</b>	<b>8</b>	Black	Orange

**9 MOUNTING/VOLTAGE**

	MOUNTING STYLE	VOLTAGE
	<b>Threaded Insert</b>	
<b>1</b>	6-32 x 0.195 inches	≥ 300
<b>C<sup>8</sup></b>	6-32 X 0.195 inches	≥ 300
<b>2</b>	ISO M3 x 5mm	< 300
<b>D<sup>8</sup></b>	ISO M3 x 5mm	≥ 300

**10 AGENCY APPROVAL**  
**C** UL Recognized & CSA Accepted  
**D<sup>9</sup>** VDE Certified, UL Recognized & CSA Accepted

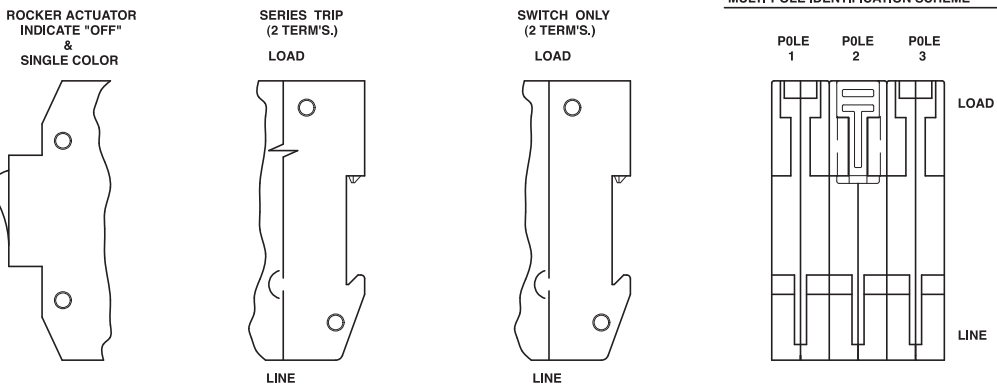
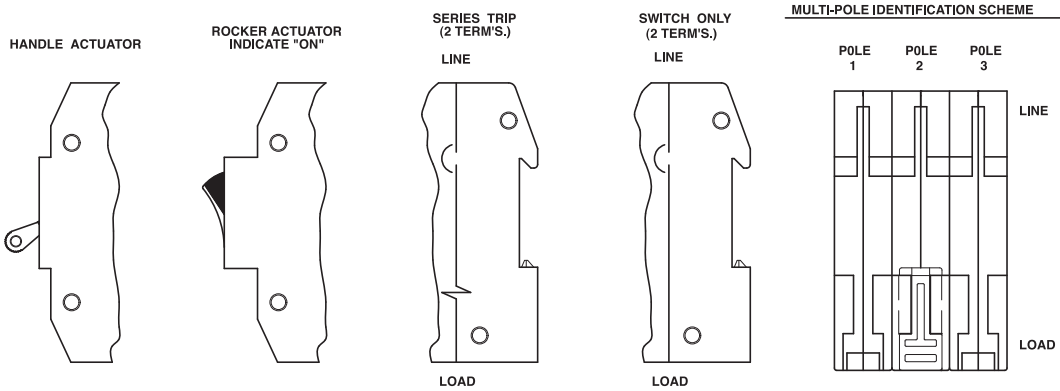

(HANDLE ACTUATOR SHOWN)

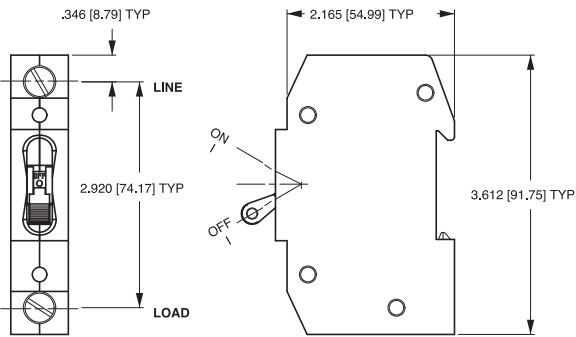
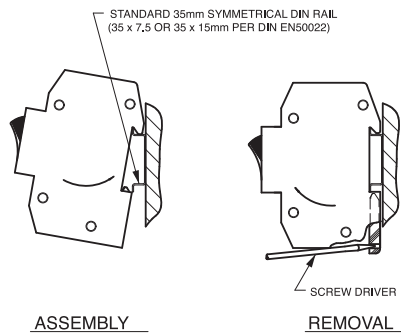
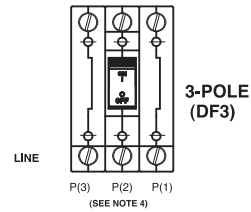
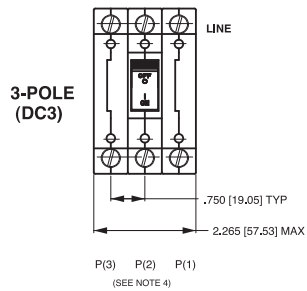
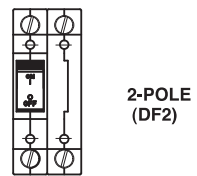
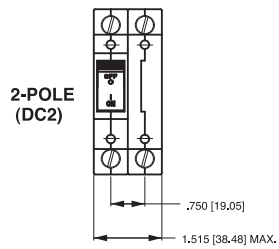
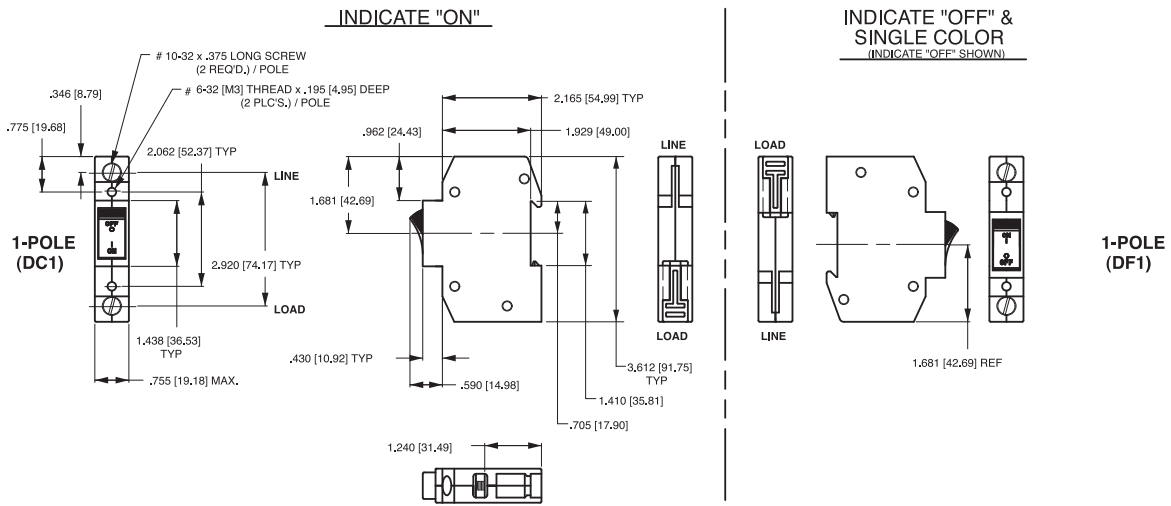

TABLE A	
TIGHTENING TORQUE SPECIFICATIONS	
THREAD SIZE	TORQUE
#6-32 [M3] HARDWARE	7-9 IN-LBS [0.8-1.0 NM]
#10-32 THD TERMINAL SCREW	15-20 IN-LBS [1.7-2.3 NM]

TERMINALS ARE SUPPLIED WITH #10-32 SCREW AND PRESSURE PLATE PER TERMINAL

Notes:

- 1 All dimensions are in inches [millimeters].
- 2 Tolerance ±.020 [.51] unless otherwise specified.



Notes:

- 1 All dimensions are in inches [millimeters].
- 2 Tolerance  $\pm 0.20$  [.51] unless otherwise specified.
- 3 Dimensions apply to all variations shown. Notice that circuit breaker line and load terminal orientation on indicate OFF is opposite of indicate ON.
- 4 For pole orientation with horizontal legend, rotate front view clockwise 90°.

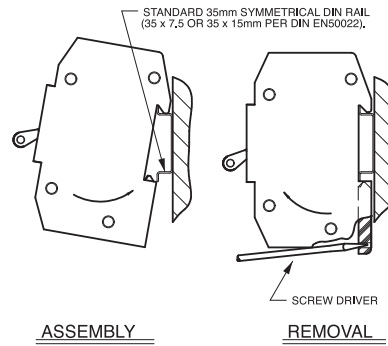
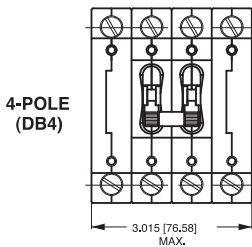
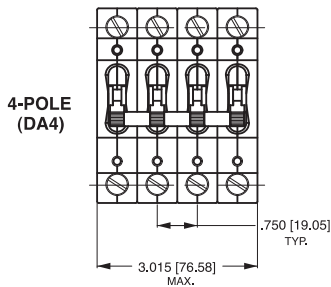
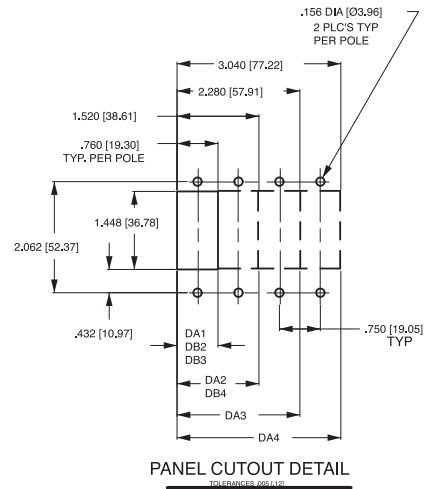
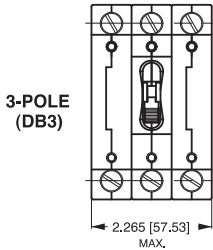
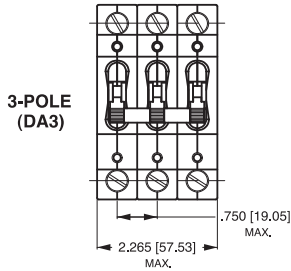
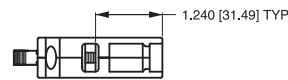
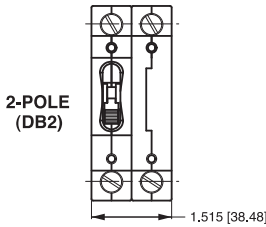
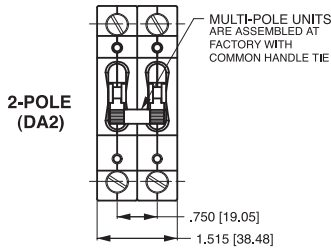
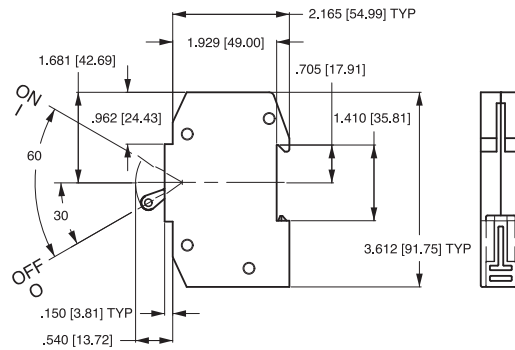
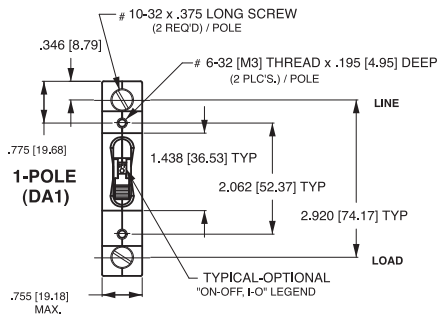

- Notes:  
 1 All dimensions are in inches [millimeters].  
 2 Tolerance ±.010 [.25] unless otherwise specified.



### **Worldwide Headquarters**

Carling Technologies, Inc.  
60 Johnson Avenue • Plainville, CT 06062  
Phone: (860) 793-9281 • Fax: (860) 793-9231  
Email: sales@carlingtech.com • www.carlingtech.com

East Region Sales Office, CT • ersm@carlingtech.com  
Midwest Region Sales Office, IL • mrsm@carlingtech.com  
West Region Sales Office, CA • wrsm@carlingtech.com

### **Asia-Pacific Headquarters**

Carling Technologies, Asia-Pacific Ltd.,  
Kowloon, Hong Kong  
Int + 852-2737-2277 • Fax: Int + 852-2736-9332  
Email: sales@carlingtech.com.hk

Shenzhen, China • shenzhen@carlingtech.com  
Shanghai, China • shanghai@carlingtech.com  
Pune, India • india@carlingtech.com  
Kaohsiung, Taiwan • taiwan@carlingtech.com  
Yokohama, Japan • japan@carlingtech.com

### **Europe / Middle East / Africa Headquarters**

Carling Technologies LTD  
4 Airport Business Park, Exeter Airport,  
Clyst Honiton, Exeter, Devon, EX5 2UL, UK  
Int + 44 1392-364422 • Fax: Int + 44 1392-364477  
Email: ltd.sales@carlingtech.com

GmbH, Germany • gmbh@carlingtech.com  
SAS, France • sas@carlingtech.com

REV\_CB\_D\_01\_2014



**Carling Technologies™**

Innovative Designs. Powerful Solutions.