

阅读申明

- 1.本站收集的数据手册和产品资料都来自互联网，版权归原作者所有。如读者和版权方有任何异议请及时告之，我们将妥善解决。
- 2.本站提供的中文数据手册是英文数据手册的中文翻译，其目的是协助用户阅读，该译文无法自动跟随原稿更新，同时也可能存在翻译上的不当。建议读者以英文原稿为参考以便获得更精准的信息。
- 3.本站提供的产品资料，来自厂商的技术支持或者使用者的心得体会等，其内容可能存在描述上的差异，建议读者做出适当判断。
- 4.如需与我们联系，请发邮件到marketing@iczoom.com，主题请标有“数据手册”字样。

Read Statement

1. The datasheets and other product information on the site are all from network reference or other public materials, and the copyright belongs to the original author and original published source. If readers and copyright owners have any objections, please contact us and we will deal with it in a timely manner.
2. The Chinese datasheets provided on the website is a Chinese translation of the English datasheets. Its purpose is for reader's learning exchange only and do not involve commercial purposes. The translation cannot be automatically updated with the original manuscript, and there may also be improper translations. Readers are advised to use the English manuscript as a reference for more accurate information.
3. All product information provided on the website refer to solutions from manufacturers' technical support or users the contents may have differences in description, and readers are advised to take the original article as the standard.
4. If you have any questions, please contact us at marketing@iczoom.com and mark the subject with "Datasheets" .

CLASS T – JLLN / JLLS SERIES FUSES

300/600 VAC • Fast-Acting • 1-1200 A

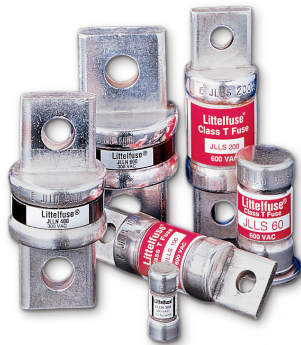

Description

JLLN / JLLS fuses are less than 1/3 the size of comparable Class R fuses and are typically used for short circuit protection of drives and surge sensitive components. When rated in accordance with the NEC®, JLLN / JLLS fuses provide fast-acting overload and short circuit protection for non-inductive circuits and equipment.

Features/Benefits

- Extremely current-limiting
- Compact design
- 200 kA Interrupting Rating
- JLLN 35-60A available with PCB mounts

Applications

- Variable speed drive protection
- Power Conversion Devices (Inverters, Rectifiers, UPS)
- Power Supplies and Power Distribution Units
- Compact mains switches

Web Resources

Download TC Curves, CAD drawings and other technical information: littelfuse.com/jlln
littelfuse.com/jlls

Recommended Fuse Holders

LFT30 Series
LFT60 Series
LSCR Series for 70-800 A

Ordering Information

AMPERE RATINGS					
1	25	70	175	450	1100
2	30	80	200	500	1200
3	35	90	225	600	
6	40	100	250	700	
10	45	110	300	800	
15	50	125	350	900*	
20	60	150	400	1000	

*JLLS only

Specifications

JLLN

Voltage Ratings

AC: 300 V
DC: 160 V (1 - 60 A)
125 V (70 - 1200 A)

Ampere Range

1 – 1200 A

Interrupting Ratings

AC: 200 kA rms symmetrical
DC: 50kA (1 - 30A)
20kA (35 - 1200A)

Approvals

AC: UL Standard 248-15, Class T
UL Listed (File: E81895): 1 – 1200 A
CSA Certified (File: LR29862): 1 – 600 A
DC: UL Listed (File: E81895): 1 – 1200 A

Material

1-30 A: Melamine body, Bronze caps
35-1200 A: Melamine body, Copper caps
RoHS Compliant

Environmental

JLLS

Voltage Ratings

AC: 600 V
DC: 300 V

Ampere Range

1 – 1200 A

Interrupting Ratings

AC: 200 kA rms symmetrical
DC: 20kA

Approvals

AC: UL Standard 248-15, Class T
UL Listed (File: E81895): 1 – 1200 A
CSA Certified (File: LR29862): 1 – 600 A
DC: Littelfuse self-certified

Material

1-30 A: Melamine body, Copper caps
35-60 A: Melamine body, Bronze caps
70-1200 A: Melamine body, Copper caps
RoHS Compliant

Environmental

Part Numbering System

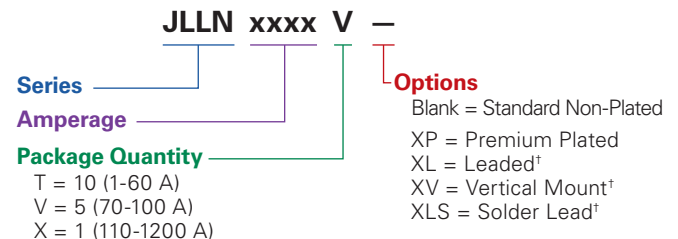

SERIES	AMP	PACK SIZE	PLATING SUFFIX	MOUNT SUFFIX	CATALOG NUMBER	ORDERING NUMBER
JLLS	6	T	–	–	JLLS006	JLLS006.T
JLLN	35	T	–	XL†	JLLN035L	JLLN035.TXL
JLLN	100	V	XP	–	JLLN100P	JLLN100.VXP

†Option is available for JLLN 35-60 A only. Premium plating is standard

CLASS T – JLLN / JLLS SERIES FUSES

Dimensions Inches (mm)

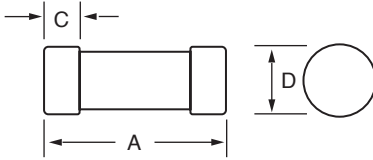

Fig. 1

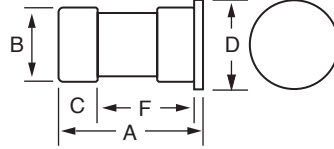

Fig. 2

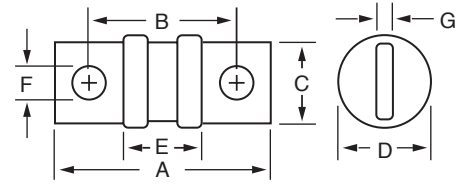
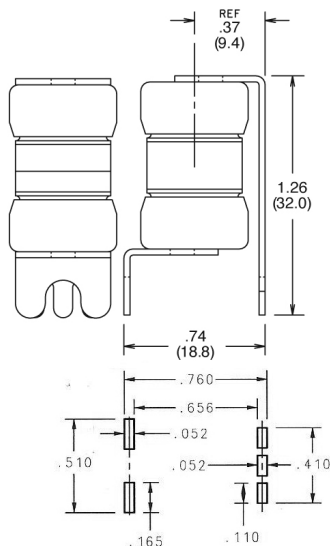

Fig. 3

AMPERES	REFER TO FIG. NO.	SERIES	DIMENSIONS INCHES (mm)						
			A	B	C	D	E	F	G
1 – 30	1	JLLN	.875 (22.2)	—	.281 (7.1)	.406 (10.3)	—	—	—
		JLLS	1.500 (38.1)	—	.281 (7.1)	.562 (14.3)	—	—	—
35 – 60	1	JLLN	.875 (22.2)	—	.281 (7.1)	.562 (14.3)	—	—	—
		JLLS	1.562 (39.7)	.812 (20.6)	.406 (10.3)	.994 (25.2)	.062 (1.6)	1.094 (27.8)	—
70 – 100	3	JLLN	2.156 (54.8)	1.562 (39.7)	.750 (19.1)	.812 (20.6)	.830 (21.1)	.281 (7.1)	.125 (3.2)
		JLLS	2.953 (75.0)	2.352 (59.7)	.750 (19.1)	.828 (21.0)	1.625 (41.3)	.281 (7.1)	.125 (3.2)
110 – 200	3	JLLN	2.437 (61.9)	1.687 (42.9)	.875 (22.2)	1.062 (27.0)	.830 (21.1)	.343 (8.7)	.187 (4.8)
		JLLS	3.250 (82.6)	2.507 (63.7)	.875 (22.2)	1.078 (27.4)	1.656 (42.1)	.343 (8.7)	.187 (4.8)
225 – 400	3	JLLN	2.750 (69.9)	1.843 (46.8)	1.000 (25.4)	1.312 (33.3)	.828 (21.0)	.406 (10.3)	.250 (6.4)
		JLLS	3.625 (92.1)	2.718 (69.1)	1.000 (25.4)	1.593 (40.5)	1.712 (43.5)	.406 (10.3)	.250 (6.4)
450 – 600	3	JLLN	3.062 (77.8)	2.031 (51.6)	1.250 (31.8)	1.593 (40.5)	.875 (22.2)	.484 (12.3)	.312 (7.9)
		JLLS	3.984 (101.2)	2.953 (75.0)	1.250 (31.8)	2.062 (52.4)	1.765 (44.8)	.484 (12.3)	.312 (7.9)
700 – 800	3	JLLN	3.375 (85.7)	2.218 (56.4)	1.750 (44.5)	2.062 (52.4)	.875 (22.2)	.546 (13.9)	.375 (9.5)
		JLLS	4.328 (109.9)	3.171 (80.6)	1.750 (44.5)	2.500 (63.5)	1.860 (47.2)	.546 (13.9)	.375 (9.5)
900 – 1200	3	JLLN	4.000 (101.6)	2.531 (64.3)	2.000 (50.8)	2.500 (63.5)	1.033 (26.2)	.609 (15.5)	.437 (11.1)
		JLLS	5.271 (133.9)	3.801 (96.5)	2.000 (50.8)	2.625 (66.7)	2.303 (58.5)	.609 (15.5)	.437 (11.1)

PCB Mounting Options (JLLN 35-60 A Only)

Vertical Mount JLLN-XV



Leaded JLLN-XL

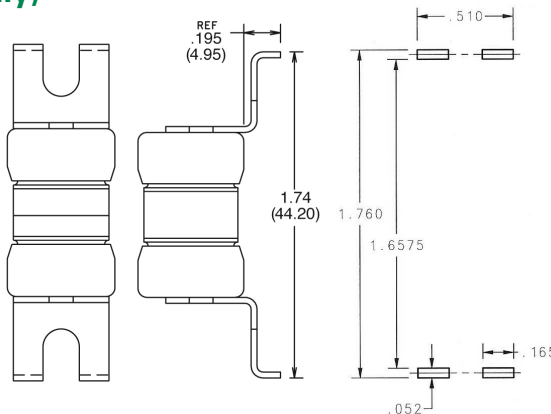

Solder JLLN-XLS

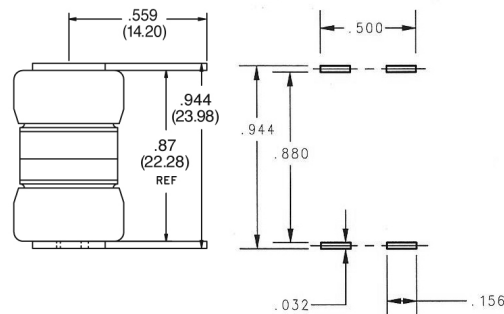

CLASS T – JLLN / JLLS SERIES FUSES

Time Current Curve JLLN (1-10A)

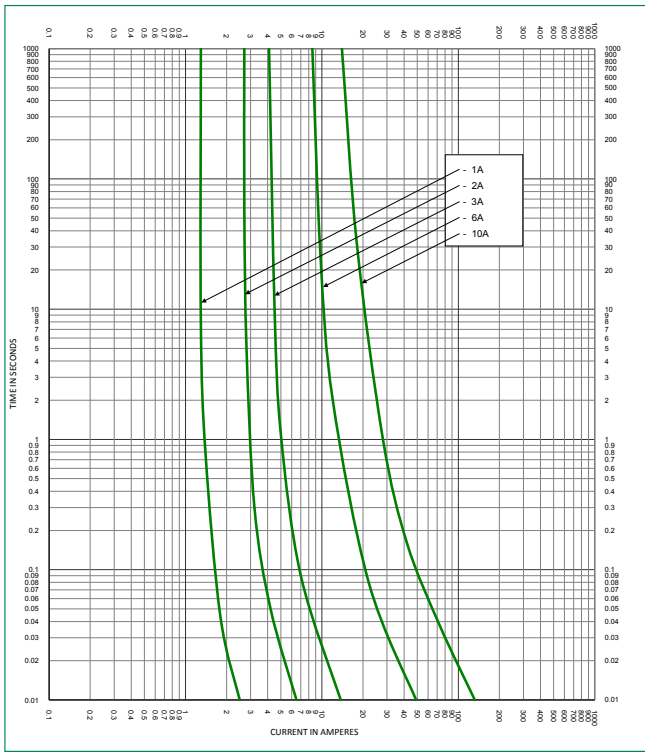

Time Current Curve JLLN (15-30A)

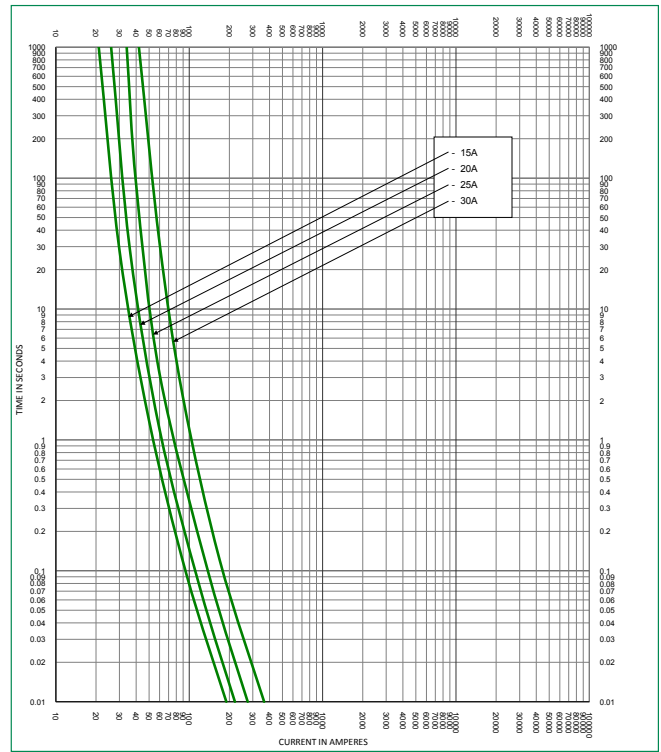

Time Current Curve JLLN (35-60A)

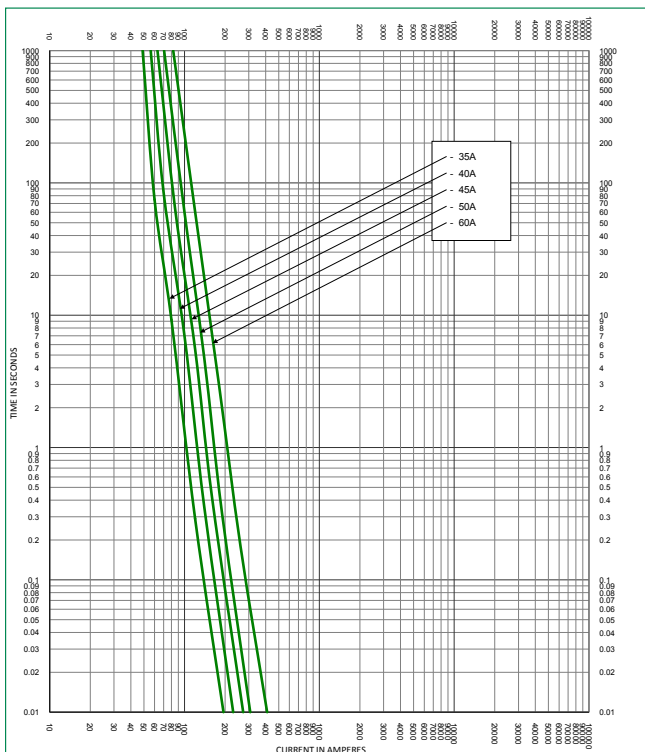

Time Current Curve JLLN (70-100A)

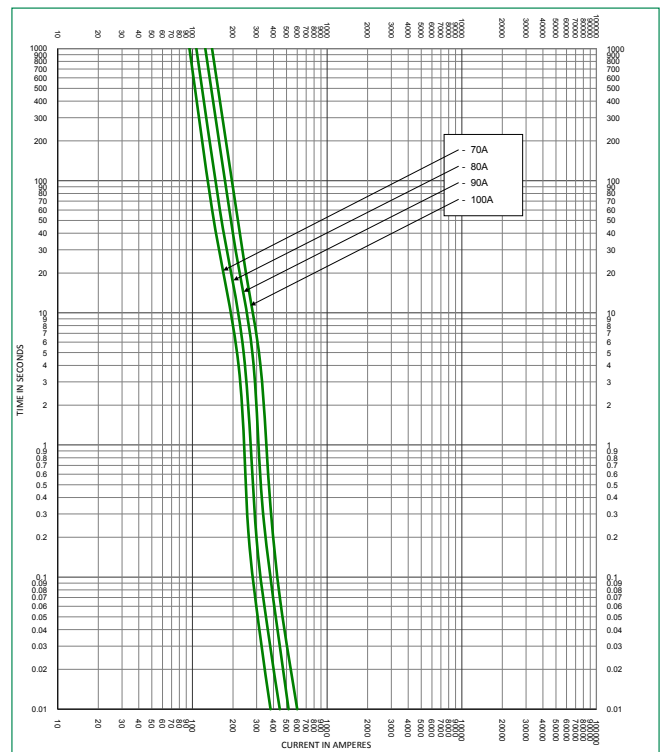

CLASS T – JLLN / JLLS SERIES FUSES

Time Current Curve JLLN (110-200A)

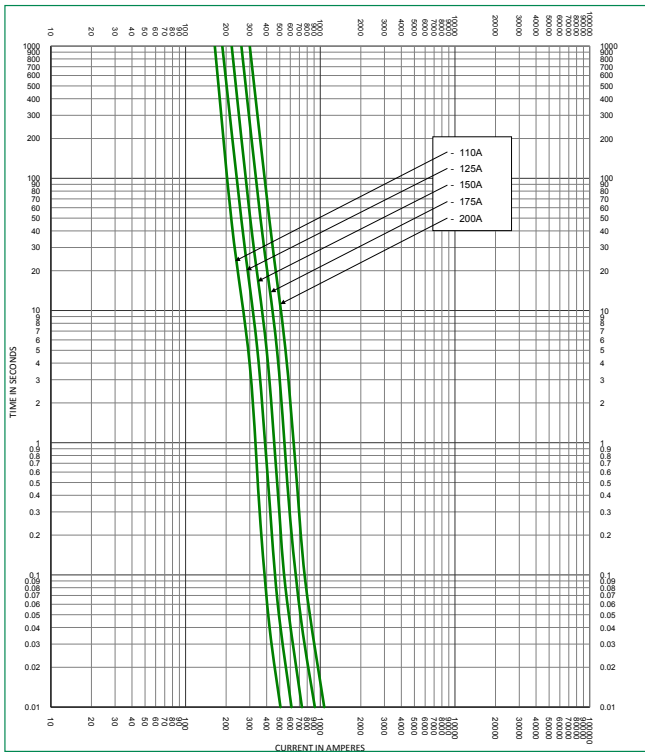

Time Current Curve JLLN (225-400A)

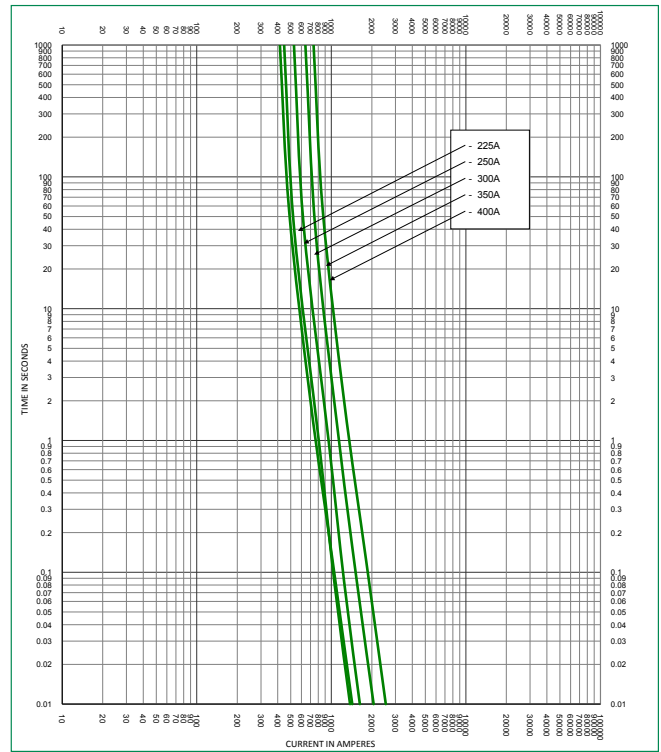

Time Current Curve JLLN (450-1200A)

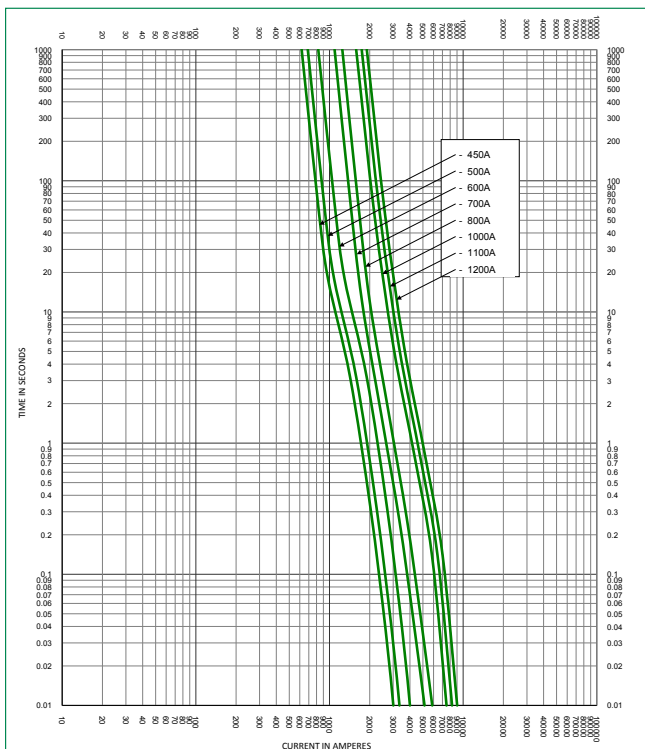

CLASS T – JLLN / JLLS SERIES FUSES

Time Current Curve JLLS (1-30A)

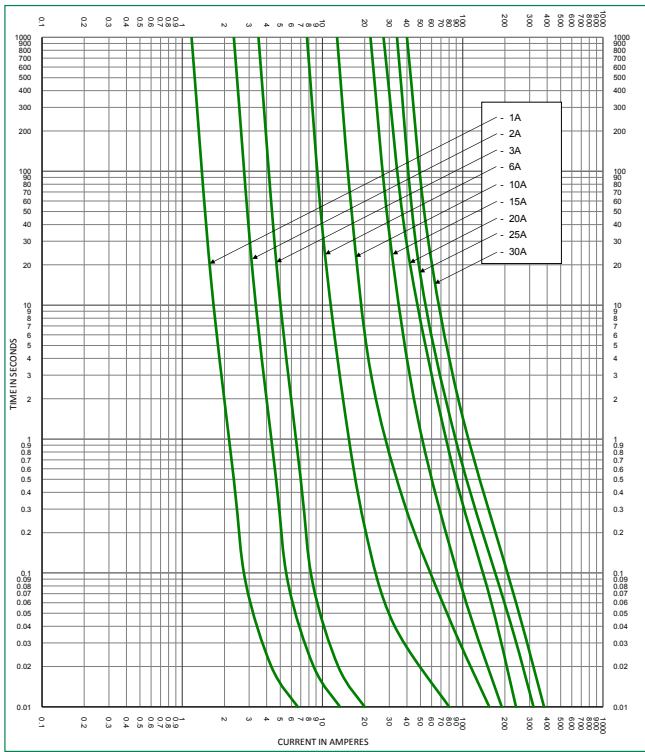

Time Current Curve JLLS (35-60A)

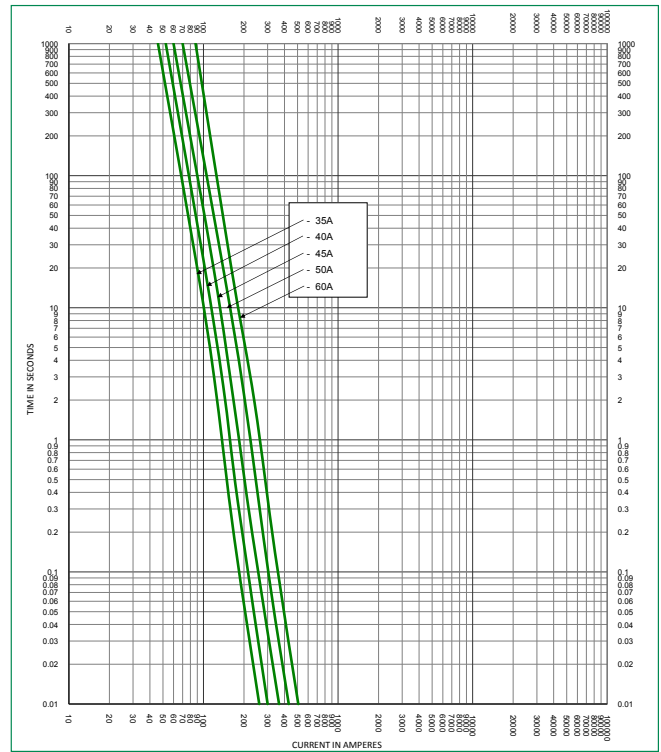

Time Current Curve JLLS (70-100A)

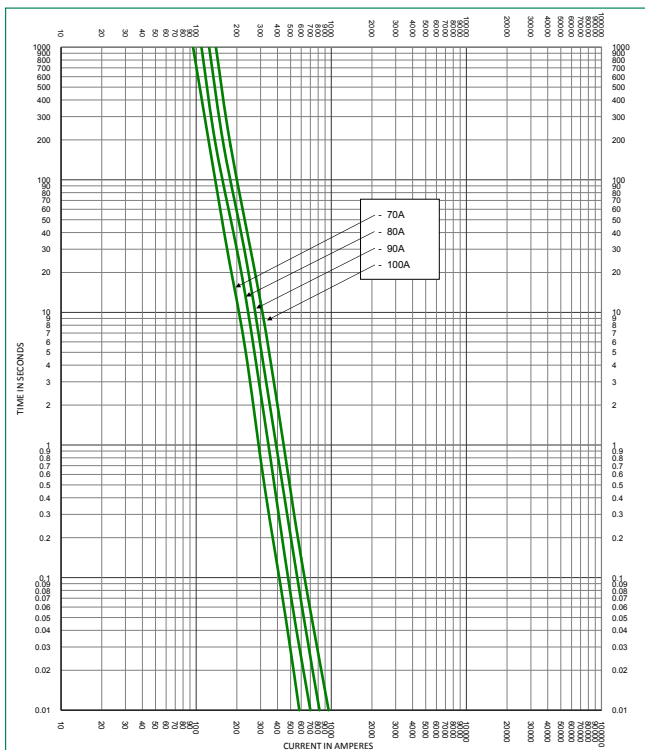

Time Current Curve JLLS (110-200A)

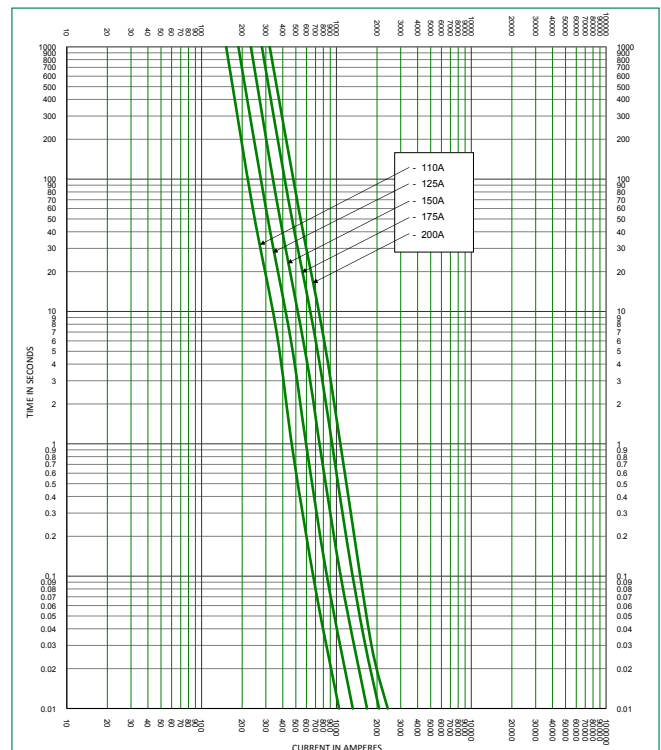

CLASS T – JLLN / JLLS SERIES FUSES

Time Current Curve JLLS (225-400A)

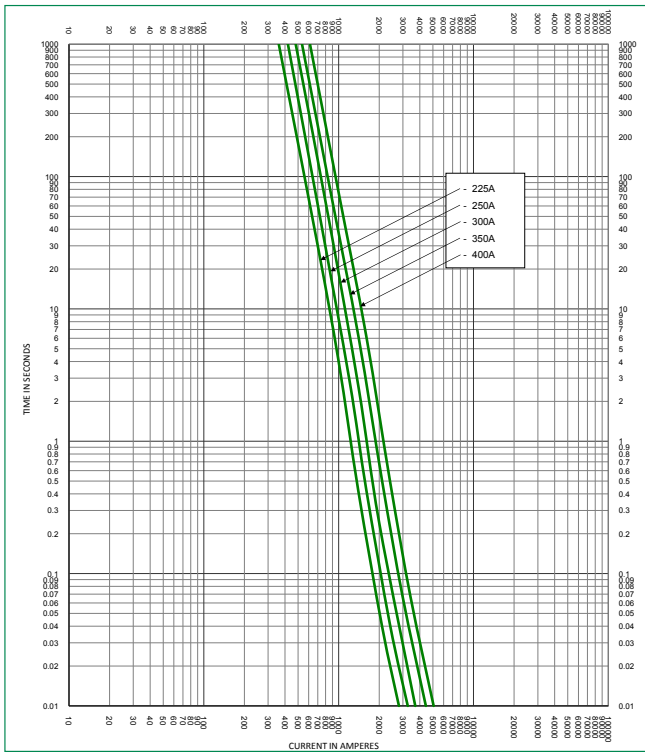

Time Current Curve JLLS (450-600A)

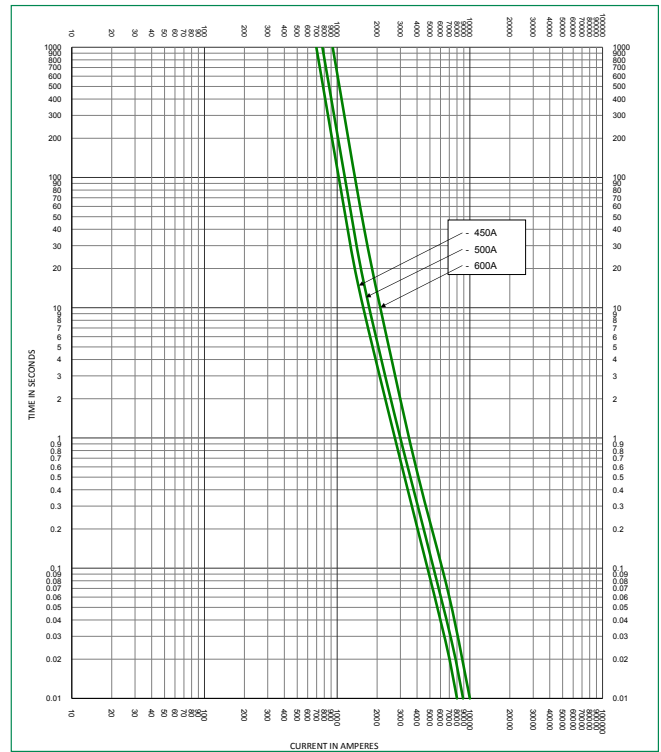

Time Current Curve JLLS (700-1200A)

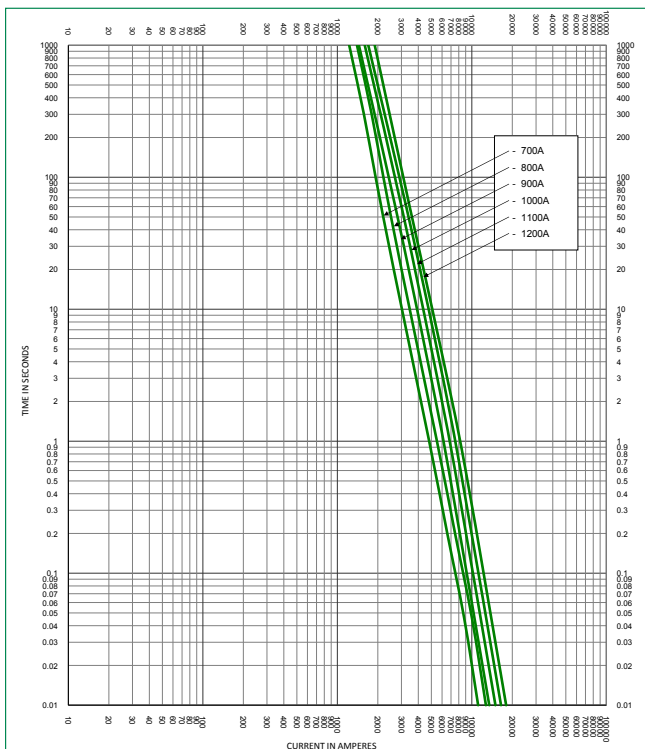

CLASS T – JLLN / JLLS SERIES FUSES

Peak Let-Thru Curve and Current-Limiting Effects of JLLN (300 V) Fuses

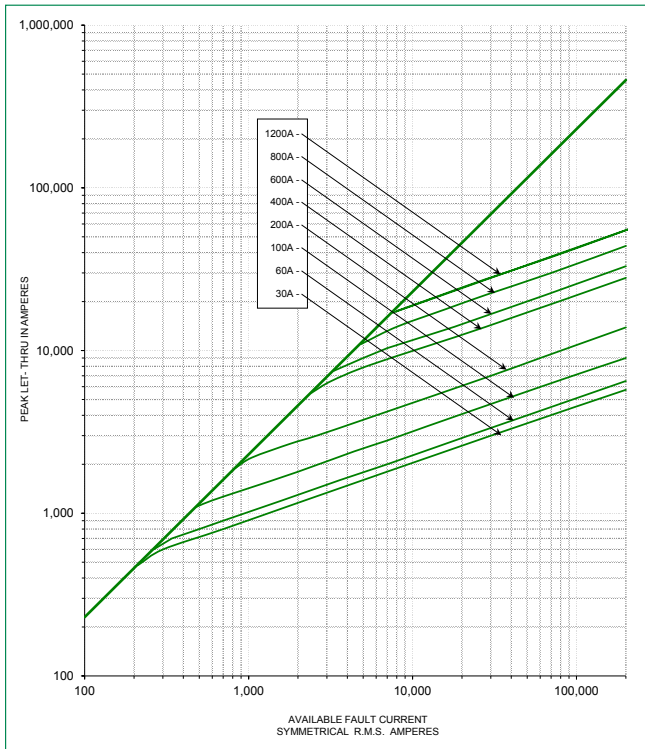

SHORT CIRCUIT CURRENT*	APPARENT RMS SYMMETRICAL CURRENT FOR VARIOUS FUSE RATINGS							
	30 A	60 A	100 A	200 A	400 A	600 A	800 A	1200 A
5,000	700	775	1,100	1,650	3,500	4,000	5,000	5,000
10,000	900	1,000	1,400	2,100	4,400	5,100	6,750	8,250
15,000	1,000	1,100	1,600	2,400	5,000	5,900	7,750	10,000
20,000	1,100	1,250	1,800	2,700	5,500	6,500	8,750	11,000
25,000	1,230	1,300	1,950	2,900	6,000	7,000	9,500	12,000
30,000	1,300	1,475	2,050	3,100	6,400	7,500	10,000	12,500
35,000	1,330	1,575	2,150	3,300	6,750	7,750	10,500	13,500
40,000	1,430	1,600	2,300	3,500	7,000	8,000	11,000	14,000
50,000	1,500	1,750	2,400	3,700	7,500	8,750	12,000	15,000
60,000	1,700	1,900	2,700	4,000	8,000	9,500	12,500	16,000
80,000	1,850	2,100	2,800	4,400	9,000	10,500	14,000	17,500
100,000	2,000	2,250	3,150	4,800	9,750	11,500	15,000	18,500
150,000	2,300	2,600	3,600	5,500	11,000	13,000	17,500	22,000
200,000	2,600	2,800	3,900	6,000	12,000	14,500	19,500	24,000

*Prospective RMS Symmetrical Amperes Short-Circuit Current
Note: Data Derived from Peak Let-Thru Curves

CLASS T – JLLN / JLLS SERIES FUSES

Peak Let-Through Curve and Current-Limiting Effects of JLLS (600 V) Fuses

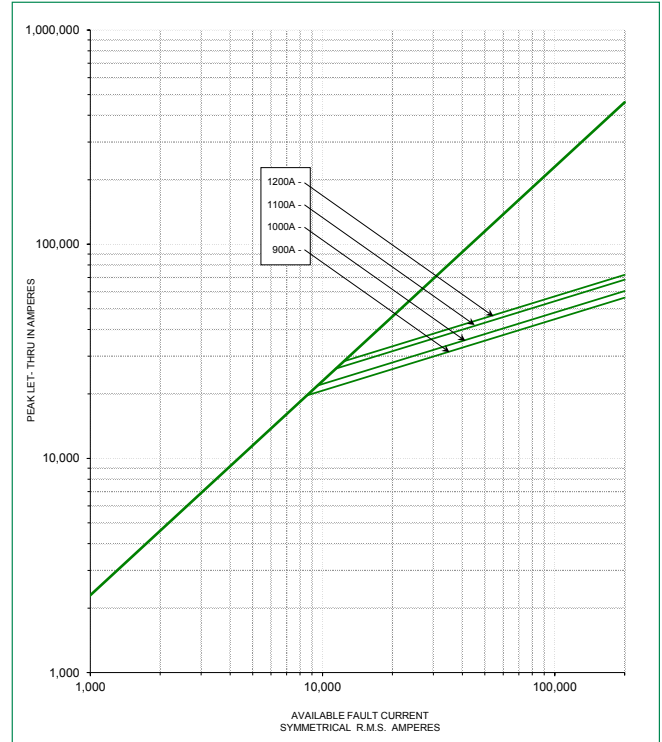
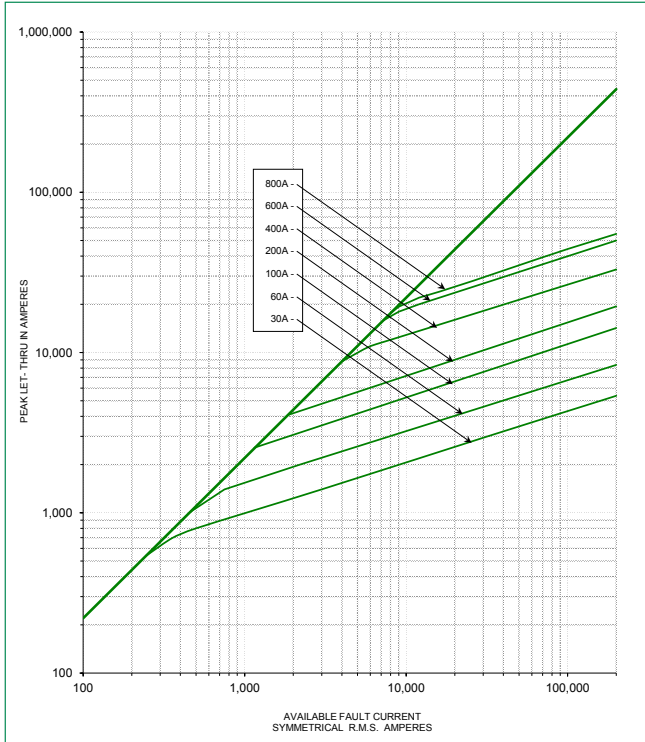

SHORT CIRCUIT CURRENT*	APPARENT RMS SYMMETRICAL CURRENT FOR VARIOUS FUSE RATINGS							
	30 A	60 A	100 A	200 A	400 A	600 A	800 A	1200 A
5,000	750	1,225	1,810	2,500	4,600	5,000	5,000	5,000
10,000	945	1,525	2,300	3,150	6,000	8,500	9,400	10,000
15,000	1,050	1,700	2,610	3,600	6,600	9,750	10,500	13,000
20,000	1,150	1,900	2,900	3,950	7,250	10,500	11,000	14,750
25,000	1,300	2,050	3,100	4,250	8,000	11,500	12,500	15,500
30,000	1,375	2,150	3,300	4,500	8,250	12,000	13,750	16,500
35,000	1,400	2,250	3,500	4,750	8,500	13,000	14,000	17,000
40,000	1,425	2,400	3,650	4,950	8,700	14,000	14,750	18,000
50,000	1,600	2,450	3,900	5,350	9,500	14,500	16,000	20,000
60,000	1,650	2,625	4,150	5,650	10,000	15,500	17,300	21,000
80,000	1,825	2,800	4,570	6,250	11,000	17,000	18,750	23,000
100,000	2,000	3,100	4,950	6,700	12,000	18,000	20,000	25,000
150,000	2,250	3,400	5,650	7,700	13,000	21,000	23,000	28,500
200,000	2,450	3,800	6,200	8,450	15,000	23,000	25,000	31,000

*Prospective RMS Symmetrical Amperes Short-Circuit Current
Note: Data Derived from Peak Let-Through Curves