

## 阅读申明

- 1.本站收集的数据手册和产品资料都来自互联网，版权归原作者所有。如读者和版权方有任何异议请及时告之，我们将妥善解决。
- 2.本站提供的中文数据手册是英文数据手册的中文翻译，其目的是协助用户阅读，该译文无法自动跟随原稿更新，同时也可能存在翻译上的不当。建议读者以英文原稿为参考以便获得更精准的信息。
- 3.本站提供的产品资料，来自厂商的技术支持或者使用者的心得体会等，其内容可能存在描述上的差异，建议读者做出适当判断。
- 4.如需与我们联系，请发邮件到marketing@iczoom.com，主题请标有“数据手册”字样。

## Read Statement

1. The datasheets and other product information on the site are all from network reference or other public materials, and the copyright belongs to the original author and original published source. If readers and copyright owners have any objections, please contact us and we will deal with it in a timely manner.
2. The Chinese datasheets provided on the website is a Chinese translation of the English datasheets. Its purpose is for reader's learning exchange only and do not involve commercial purposes. The translation cannot be automatically updated with the original manuscript, and there may also be improper translations. Readers are advised to use the English manuscript as a reference for more accurate information.
3. All product information provided on the website refer to solutions from manufacturers' technical support or users the contents may have differences in description, and readers are advised to take the original article as the standard.
4. If you have any questions, please contact us at marketing@iczoom.com and mark the subject with "Datasheets" .

# KLKD SERIES 10x38 FUSES

600 Vac/dc • 1/10-30 A • Fast Acting



## Description

The KLKD fuse series is fast-acting with a high DC voltage rating. This family of Midget style fuses (10 x 38 mm) is used in solar combiner boxes and in circuits with DC fault currents up to 50,000 amperes. KLKD fuses are available in standard and board-mount configurations.

In addition, the KLKD series has been designed to meet both the UL and IEC photovoltaic fuse standards.

Littelfuse offers a wide range of ampere ratings to match specific requirements in a variety of applications.

## Features/Benefits

- Designed to UL and IEC photovoltaic specifications
- 1/10 - 30 A ratings available
- 50,000 A Interrupting Rating
- Available in ferrule or PCB mount options
- 1-5 A meets UL1741 GFDI requirements

## Applications

- Combiner boxes and Inverters
- Power supplies
- Desktop meters

## Dimensions Inches (mm)

### Ferrule Version

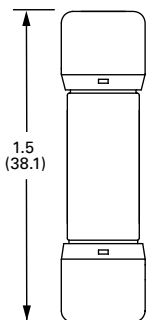

### PCB 1-Tab

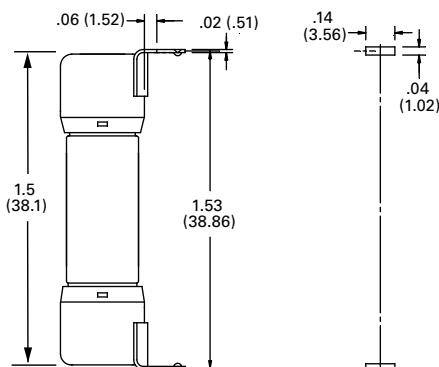

MOUNTING HOLE DETAIL

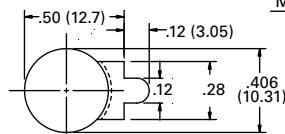
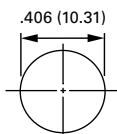

## Specifications

|                               |                                                                                                                                                                           |
|-------------------------------|---------------------------------------------------------------------------------------------------------------------------------------------------------------------------|
| <b>Voltage Rating:</b>        | 600 Vac/Vdc                                                                                                                                                               |
| <b>Amperage Rating:</b>       | 1/10, 1/8, 2/10, 1/4, 3/10, 1/2, 3/4, 1, 1 1/2, 2, 2 1/2, 3, 3 1/2, 4, 5, 6, 7, 8, 9, 10, 12, 15, 20, 25, 30                                                              |
| <b>Interrupting Ratings:</b>  | AC: 100 kA<br>200 kA Littelfuse self-certified                                                                                                                            |
| <b>Material:</b>              | Body: Melamine / Caps: Copper Alloy                                                                                                                                       |
| <b>Operating Temperature:</b> | See Rating Curve                                                                                                                                                          |
| <b>Approvals:</b>             | UL 248-19 Listed (File: E339112)<br>IEC 60269-6 (2-25 A)<br>VDE Certified (No. 40033094)<br>UL 248-14 Listed (File: E10480)<br>CSA Certified Ferrule only (File: LR29862) |
| <b>Environmental:</b>         | RoHS Compliant                                                                                                                                                            |
| <b>Country of Origin:</b>     | Mexico                                                                                                                                                                    |

## Part Numbering System

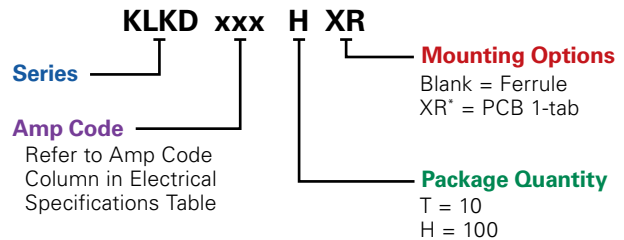

| SERIES | AMP | PACKAGE QUANTITY | MOUNTING METHOD | CATALOG NUMBER | ORDERING NUMBER |
|--------|-----|------------------|-----------------|----------------|-----------------|
| KLKD   | 1/8 | 10               | FERRULE         | KLKD 1/8       | KLKD.125T       |
| KLKD   | 5   | 100              | FERRULE         | KLKD 5         | KLKD005.H       |
| KLKD   | 15  | 100              | PCB 1-TAB       | KLKD 15-R      | KLKD015.HXR     |

\*Only available in 100 packs (H) and select ratings.

## Recommended Fuse Holders

Littelfuse LFPSM and LPSM Dead-Front Series  
Littelfuse L60030M Open-Face Series

## Web Resources

Download CAD drawings and other technical information:  
[littelfuse.com/klkd](http://littelfuse.com/klkd)

# KLKD SERIES 10x38 FUSES

## Ordering Information

### Ferrule Version

| AMP RATING | AMP CODE | CATALOG NUMBER | ORDERING NUMBER | VOLTAGE |     | INTERRUPTING RATING (kA) |             | UPC         | WEIGHT LB (G) | AGENCY APPROVALS |     |  |
|------------|----------|----------------|-----------------|---------|-----|--------------------------|-------------|-------------|---------------|------------------|-----|--|
|            |          |                |                 | DC & AC | AC  | DC                       | UL          |             |               | VDE              | CSA |  |
| 1/10       | .100     | KLKD 1/10      | KLKD.100T       | 600     | 100 | 50                       | 07945810189 | .013 (5.90) | •             |                  | •   |  |
| 1/8        | .125     | KLKD 1/8       | KLKD.125T       | 600     | 100 | 50                       | 07945810190 | .013 (5.90) | •             |                  | •   |  |
| 2/10       | .20      | KLKD 2/10      | KLKD.200T       | 600     | 100 | 50                       | 07945810191 | .013 (5.90) | •             |                  | •   |  |
| 1/4        | .250     | KLKD 1/4       | KLKD.250T       | 600     | 100 | 50                       | 07945810192 | .013 (5.90) | •             |                  | •   |  |
| 3/10       | .300     | KLKD 3/10      | KLKD.300T       | 600     | 100 | 50                       | 07945810193 | .013 (5.90) | •             |                  | •   |  |
| 1/2        | .500     | KLKD 1/2       | KLKD.500T       | 600     | 100 | 50                       | 07945810194 | .013 (5.90) | •             |                  | •   |  |
| 3/4        | .750     | KLKD 3/4       | KLKD.750T       | 600     | 100 | 50                       | 07945810195 | .013 (5.90) | •             |                  | •   |  |
| 1          | 001      | KLKD 1         | KLKD001.T       | 600     | 100 | 50                       | 07945810196 | .013 (5.90) | •             |                  | •   |  |
| 1 1/2      | 01.5     | KLKD 1 1/2     | KLKD01.5T       | 600     | 100 | 50                       | 07945810197 | .013 (5.90) | •             |                  | •   |  |
| 2          | 002      | KLKD 2         | KLKD002.T       | 600     | 100 | 50                       | 07945810198 | .017 (7.71) | •             | •                | •   |  |
| 2 1/2      | 02.5     | KLKD 2 1/2     | KLKD02.5T       | 600     | 100 | 50                       | 07945810199 | .017 (7.71) | •             | •                | •   |  |
| 3          | 003      | KLKD 3         | KLKD003.T       | 600     | 100 | 50                       | 07945810200 | .017 (7.71) | •             | •                | •   |  |
| 3 1/2      | 03.5     | KLKD 3 1/2     | KLKD03.5T       | 600     | 100 | 50                       | 07945810214 | .017 (7.71) | •             | •                | •   |  |
| 4          | 004      | KLKD 4         | KLKD004.T       | 600     | 100 | 50                       | 07945810201 | .017 (7.71) | •             | •                | •   |  |
| 5          | 005      | KLKD 5         | KLKD005.T       | 600     | 100 | 50                       | 07945810202 | .017 (7.71) | •             | •                | •   |  |
| 6          | 006      | KLKD 6         | KLKD006.T       | 600     | 100 | 50                       | 07945810203 | .017 (7.71) | •             | •                | •   |  |
| 7          | 007      | KLKD 7         | KLKD007.T       | 600     | 100 | 50                       | 07945810204 | .017 (7.71) | •             | •                | •   |  |
| 8          | 008      | KLKD 8         | KLKD008.T       | 600     | 100 | 50                       | 07945810205 | .017 (7.71) | •             | •                | •   |  |
| 9          | 009      | KLKD 9         | KLKD009.T       | 600     | 100 | 50                       | 07945810215 | .017 (7.71) | •             | •                | •   |  |
| 10         | 010      | KLKD 10        | KLKD010.T       | 600     | 100 | 50                       | 07945810206 | .017 (7.71) | •             | •                | •   |  |
| 12         | 012      | KLKD 12        | KLKD012.T       | 600     | 100 | 50                       | 07945810207 | .017 (7.71) | •             | •                | •   |  |
| 15         | 015      | KLKD 15        | KLKD015.T       | 600     | 100 | 50                       | 07945810208 | .017 (7.71) | •             | •                | •   |  |
| 20         | 020      | KLKD 20        | KLKD020.T       | 600     | 100 | 50                       | 07945810209 | .017 (7.71) | •             | •                | •   |  |
| 25         | 025      | KLKD 25        | KLKD025.T       | 600     | 100 | 50                       | 07945810210 | .017 (7.71) | •             | •                | •   |  |
| 30         | 030      | KLKD 30        | KLKD030.T       | 600     | 100 | 50                       | 07945810211 | .017 (7.71) | •             |                  | •   |  |

### PCB 1-Tab Version

| AMP RATING | AMP CODE | CATALOG NUMBER | ORDERING NUMBER | VOLTAGE RATING |     | INTERRUPTING RATING (kA) |             | UPC | APPROVALS |  |
|------------|----------|----------------|-----------------|----------------|-----|--------------------------|-------------|-----|-----------|--|
|            |          |                |                 | DC & AC        | AC  | DC                       | UL          |     | CE        |  |
| 1/10       | .100     | KLKD 1/10-R    | KLKD.100HXR     | 600            | 100 | 50                       | 07945814857 | •   | •         |  |
| 1/2        | .500     | KLKD 1/2-R     | KLKD.500HXR     | 600            | 100 | 50                       | 07945814858 | •   | •         |  |
| 1          | 001      | KLKD 1-R       | KLKD001.HXR     | 600            | 100 | 50                       | 07945812133 | •   | •         |  |
| 2          | 002      | KLKD 2-R       | KLKD002.HXR     | 600            | 100 | 50                       | 07945894349 | •   | •         |  |
| 3          | 003      | KLKD 3-R       | KLKD003.HXR     | 600            | 100 | 50                       | 07945818991 | •   | •         |  |
| 4          | 004      | KLKD 4-R       | KLKD004.HXR     | 600            | 100 | 50                       | 07945811495 | •   | •         |  |
| 5          | 005      | KLKD 5-R       | KLKD005.HXR     | 600            | 100 | 50                       | 07945814859 | •   | •         |  |
| 6          | 006      | KLKD 6-R       | KLKD006.HXR     | 600            | 100 | 50                       | 07945894350 | •   | •         |  |
| 8          | 008      | KLKD 8-R       | KLKD008.HXR     | 600            | 100 | 50                       | 07945894351 | •   | •         |  |
| 10         | 010      | KLKD 10-R      | KLKD010.HXR     | 600            | 100 | 50                       | 07945814860 | •   | •         |  |
| 12         | 012      | KLKD 12-R      | KLKD012.HXR     | 600            | 100 | 50                       | 07945894352 | •   | •         |  |
| 15         | 015      | KLKD 15-R      | KLKD015.HXR     | 600            | 100 | 50                       | 07945894353 | •   | •         |  |
| 20         | 020      | KLKD 20-R      | KLKD020.HXR     | 600            | 100 | 50                       | 07945894354 | •   | •         |  |
| 25         | 025      | KLKD 25-R      | KLKD025.HXR     | 600            | 100 | 50                       | 07945894355 | •   | •         |  |
| 30         | 030      | KLKD 30-R      | KLKD030.HXR     | 600            | 100 | 50                       | 07945894356 | •   | •         |  |

# KLKD SERIES 10x38 FUSES

## Electrical Specifications

| AMP RATING | CATALOG NUMBER | NOM COLD RESISTANCE (ohms) | AVERAGE MELT TIME | AVERAGE MELTING I <sup>2</sup> t | WATTS LOSS AT 100% RATED CURRENT (W) | WATTS LOSS AT 80% RATED CURRENT (W) | AVERAGE CLEARING TIME | TOTAL CLEARING I <sup>2</sup> t (A <sup>2</sup> s) 20 kA | TOTAL CLEARING I <sup>2</sup> t (A <sup>2</sup> s) 100 kA |
|------------|----------------|----------------------------|-------------------|----------------------------------|--------------------------------------|-------------------------------------|-----------------------|----------------------------------------------------------|-----------------------------------------------------------|
| 1/10       | KLKD 1/10      | 85.5                       | –                 | –                                | 0.780                                | 0.505                               | 0.000047              | 0.019                                                    | –                                                         |
| 1/8        | KLKD 1/8       | 65                         | –                 | –                                | 0.975                                | 0.659                               | 0.000050              | 0.010                                                    | –                                                         |
| 2/10       | KLKD 2/10      | 30.9                       | –                 | –                                | 1.213                                | 0.773                               | 0.000073              | 0.032                                                    | –                                                         |
| 1/4        | KLKD 1/4       | 22                         | –                 | –                                | 1.364                                | 0.870                               | –                     | –                                                        | –                                                         |
| 3/10       | KLKD 3/10      | 16.2                       | –                 | –                                | 1.519                                | 0.960                               | 0.000101              | 0.067                                                    | –                                                         |
| 1/2        | KLKD 1/2       | 8.16                       | –                 | –                                | 1.961                                | 1.237                               | 0.000141              | 0.197                                                    | –                                                         |
| 3/4        | KLKD 3/4       | 0.402                      | 0.000063          | 0.234                            | 0.361                                | 0.199                               | 0.000170              | 0.753                                                    | –                                                         |
| 1          | KLKD 1         | 0.252                      | 0.000094          | 0.678                            | 0.388                                | 0.273                               | 0.000247              | 1.827                                                    | 0.008                                                     |
| 1 1/2      | KLKD 1 1/2     | 0.134                      | 0.000153          | 2.890                            | 0.409                                | 0.229                               | 0.000828              | 13.956                                                   | 280                                                       |
| 2          | KLKD 2         | 0.129                      | 0.000145          | 2.379                            | 0.823                                | 0.606                               | 0.000291              | 3.919                                                    | 0.012                                                     |
| 2 1/2      | KLKD 2 1/2     | 0.0989                     | 0.000186          | 5.142                            | 0.912                                | 0.618                               | 0.000387              | 8.877                                                    | –                                                         |
| 3          | KLKD 3         | 0.0773                     | 0.000211          | 7.821                            | 0.957                                | 0.654                               | 0.000449              | 14.835                                                   | –                                                         |
| 3 1/2      | KLKD 3 1/2     | 0.0613                     | 0.000249          | 12.417                           | 1.12                                 | 0.826                               | 0.000471              | 21.048                                                   | –                                                         |
| 4          | KLKD 4         | 0.0511                     | 0.000284          | 18.945                           | 1.367                                | 0.891                               | 0.000507              | 30.76                                                    | 0.019                                                     |
| 5          | KLKD 5         | 0.0363                     | 0.000347          | 34.163                           | 1.4                                  | 0.938                               | 0.000607              | 56.514                                                   | 0.024                                                     |
| 6          | KLKD 6         | 0.0261                     | 0.000423          | 62.951                           | 1.516                                | 0.998                               | 0.000735              | 96.824                                                   | 0.035                                                     |
| 7          | KLKD 7         | 0.0205                     | 0.000505          | 105.143                          | 1.577                                | 1.066                               | 0.000898              | 168.578                                                  | 0.087                                                     |
| 8          | KLKD 8         | 0.0194                     | 0.000541          | 130.266                          | 1.824                                | 1.205                               | 0.000945              | 210.595                                                  | 0.656                                                     |
| 9          | KLKD 9         | 0.0166                     | 0.000587          | 164.221                          | 2.208                                | 1.428                               | 0.000992              | 266.633                                                  | –                                                         |
| 10         | KLKD 10        | 0.0128                     | 0.000701          | 278.390                          | 1.893                                | 1.3                                 | 0.001200              | 454.628                                                  | 211.667                                                   |
| 12         | KLKD 12        | 0.0103                     | 0.000822          | 445.010                          | 2.296                                | 1.584                               | 0.001455              | 744.775                                                  | 440                                                       |
| 15         | KLKD 15        | .007855                    | 0.000544          | 137.333                          | 2.045                                | 1.57                                | 0.001721              | 351.24                                                   | –                                                         |
| 20         | KLKD 20        | 0.0045                     | 0.000826          | 462.056                          | 2.133                                | 1.593                               | 0.006144              | 1151.185                                                 | 2120                                                      |
| 25         | KLKD 25        | 0.003532                   | 0.001007          | 834.529                          | 2.55                                 | 1.933                               | 0.002085              | 1744.033                                                 | 2085                                                      |
| 30         | KLKD 30        | 0.002776                   | 0.001207          | 1409                             | 3.701                                | 1.983                               | 0.002266              | 2757                                                     | 3220                                                      |

Note: Test Circuit 600 Vac / 20 kA

# KLKD SERIES 10x38 FUSES

## Current-Limiting Effects

| SHORT CIRCUIT CURRENT* | APPARENT RMS SYMMETRICAL CURRENT FOR VARIOUS FUSE RATINGS |      |      |      |
|------------------------|-----------------------------------------------------------|------|------|------|
|                        | 1 ½ A                                                     | 12 A | 25 A | 30 A |
| 5,000                  | 240                                                       | 292  | 654  | 722  |
| 10,000                 | 303                                                       | 367  | 823  | 910  |
| 15,000                 | 347                                                       | 420  | 943  | 1042 |
| 20,000                 | 381                                                       | 463  | 1037 | 1147 |
| 25,000                 | 411                                                       | 498  | 1117 | 1235 |
| 30,000                 | 437                                                       | 530  | 1188 | 1313 |
| 35,000                 | 460                                                       | 558  | 1250 | 1382 |
| 40,000                 | 481                                                       | 583  | 1307 | 1445 |
| 50,000                 | 518                                                       | 628  | 1408 | 1556 |
| 60,000                 | 550                                                       | 667  | 1496 | 1654 |
| 80,000                 | 605                                                       | 735  | 1647 | 1820 |
| 100,000                | 652                                                       | 791  | 1774 | 1961 |

\*Prospective RMS Symmetrical Amperes Short-Circuit Current

## Electrical Specification – Agency Requirements

| AMPERAGE RATING | OPENING TIME (MINUTES)    |                            |                           |                            |                           |
|-----------------|---------------------------|----------------------------|---------------------------|----------------------------|---------------------------|
|                 | 100% of Amp Rating per UL | 113% of Amp Rating per IEC | 135% of Amp Rating per UL | 145% of Amp Rating per IEC | 200% of Amp Rating per UL |
| 1/10-30         | Temperature Stabilization | 60 Min                     | 60 Max                    | 60 Max                     | 4 Max                     |

## Temperature Derating Curve (Temperature of Air Immediately Surrounding Fuse)

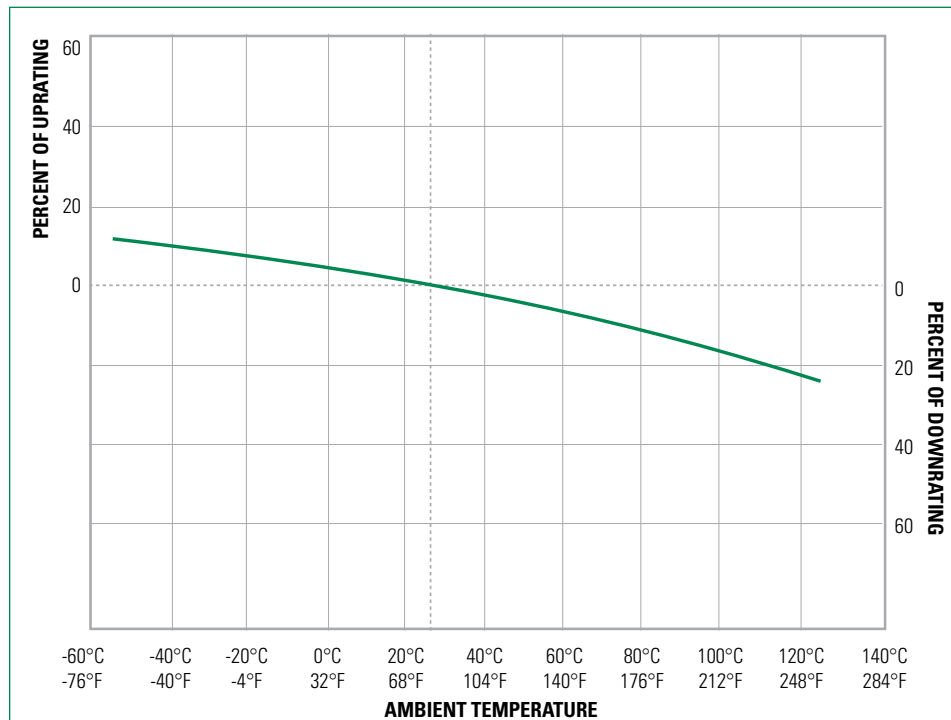

# KLKD SERIES 10x38 FUSES

## Recommended Process and Soldering Parameters

| WAVE PARAMETER         | LEAD FREE RECOMMENDATION          |
|------------------------|-----------------------------------|
| Preheat:               | (Typical Industry Recommendation) |
| Temperature Minimum:   | 130° C                            |
| Temperature Maximum:   | —                                 |
| Pre-heat time          | 75 Seconds Maximum                |
| Solder Pot Temperature | 280° C Maximum                    |
| Solder Dwell Time      | 270° C for 8 Seconds Maximum      |
| Complete Cycle Time    | 250 Seconds Maximum               |

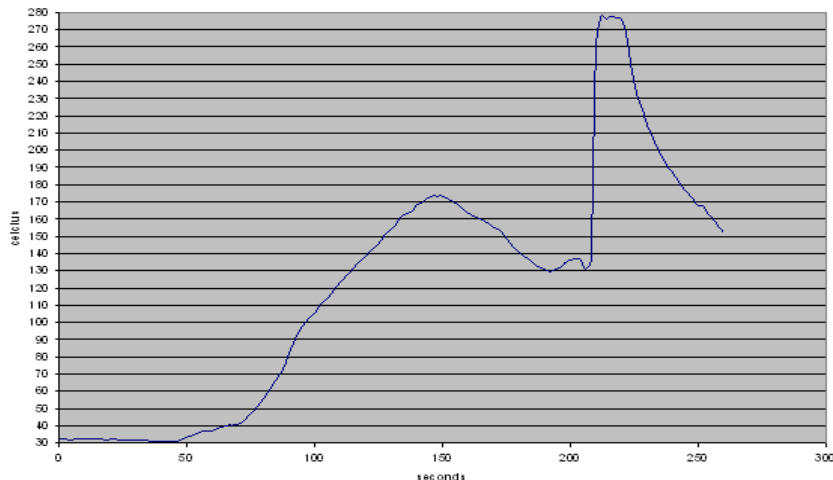

## Peak Let Thru Curve

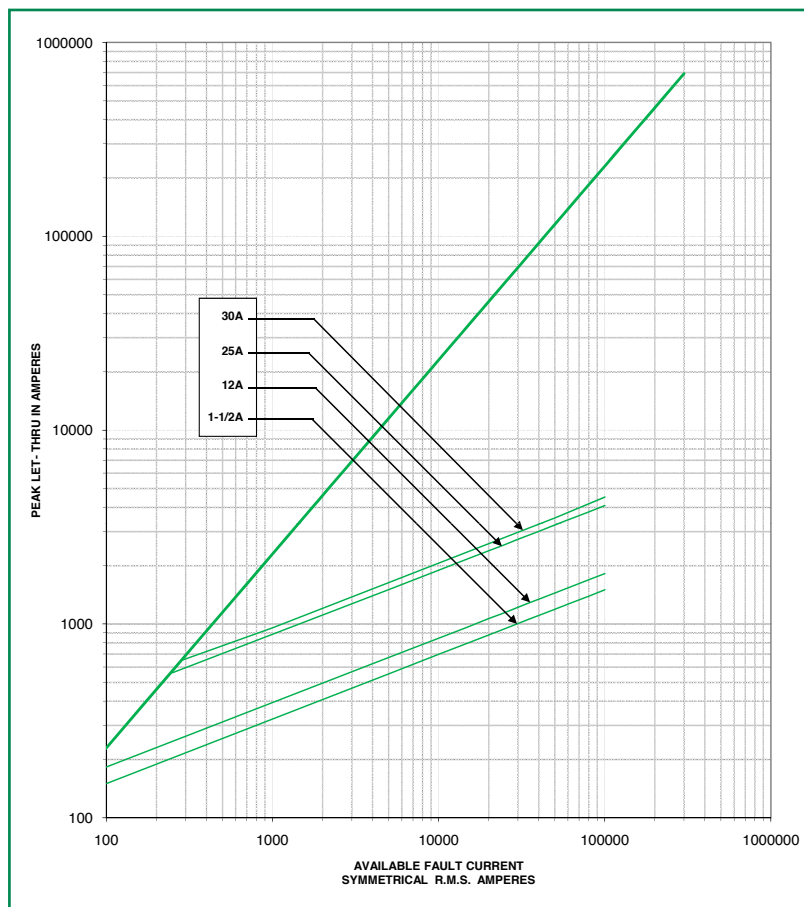

# KLKD SERIES 10x38 FUSES

**Time Current Curve (1/8 - 2 1/2 A)**

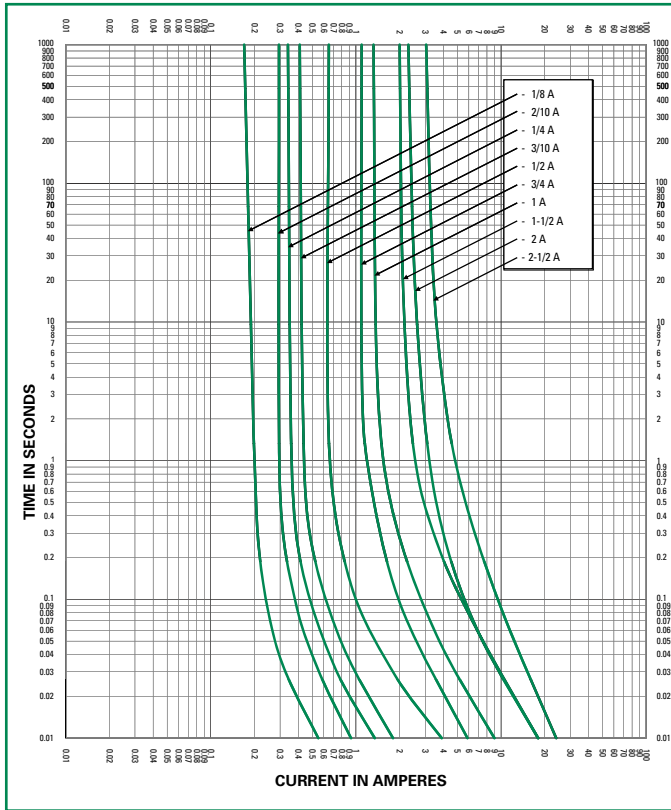

**Time Current Curve (3 - 12 A)**

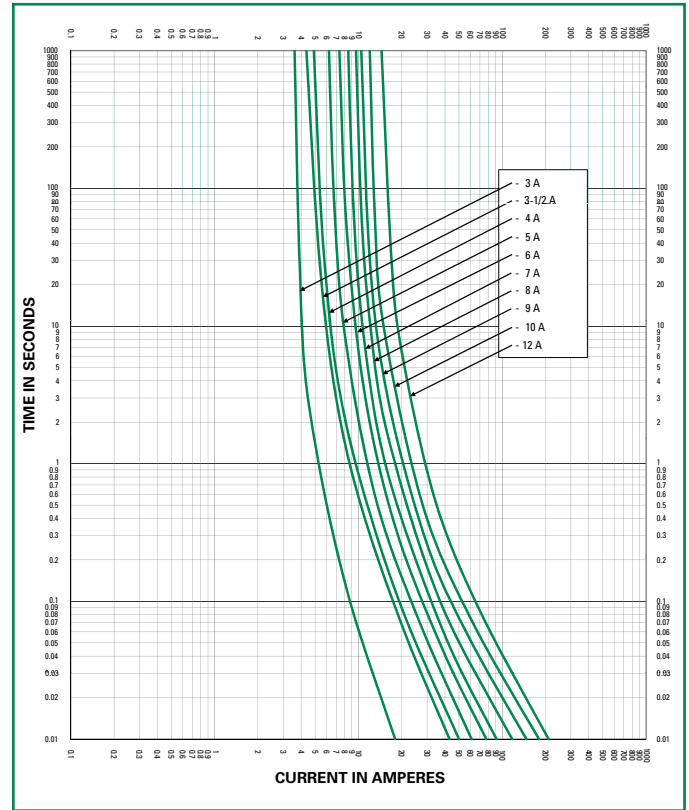

**Time Current Curve (15 - 25 A)**

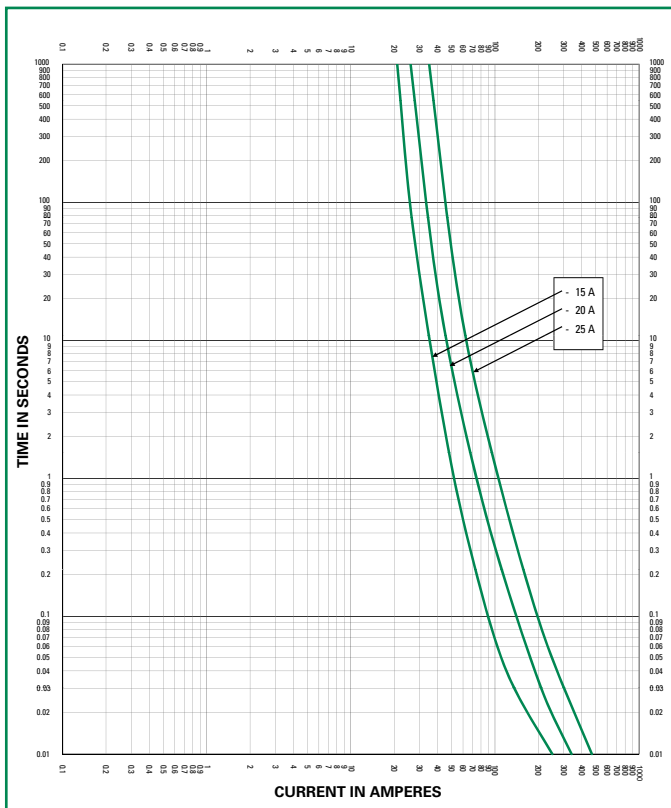

**Time Current Curve (30 A)**

