

阅读申明

- 1.本站收集的数据手册和产品资料都来自互联网，版权归原作者所有。如读者和版权方有任何异议请及时告之，我们将妥善解决。
- 2.本站提供的中文数据手册是英文数据手册的中文翻译，其目的是协助用户阅读，该译文无法自动跟随原稿更新，同时也可能存在翻译上的不当。建议读者以英文原稿为参考以便获得更精准的信息。
- 3.本站提供的产品资料，来自厂商的技术支持或者使用者的心得体会等，其内容可能存在描述上的差异，建议读者做出适当判断。
- 4.如需与我们联系，请发邮件到marketing@iczoom.com，主题请标有“数据手册”字样。

Read Statement

1. The datasheets and other product information on the site are all from network reference or other public materials, and the copyright belongs to the original author and original published source. If readers and copyright owners have any objections, please contact us and we will deal with it in a timely manner.
2. The Chinese datasheets provided on the website is a Chinese translation of the English datasheets. Its purpose is for reader's learning exchange only and do not involve commercial purposes. The translation cannot be automatically updated with the original manuscript, and there may also be improper translations. Readers are advised to use the English manuscript as a reference for more accurate information.
3. All product information provided on the website refer to solutions from manufacturers' technical support or users the contents may have differences in description, and readers are advised to take the original article as the standard.
4. If you have any questions, please contact us at marketing@iczoom.com and mark the subject with "Datasheets" .

S505H

5 mm x 20 mm 400 Vdc/500-600 Vac time-delay fuses

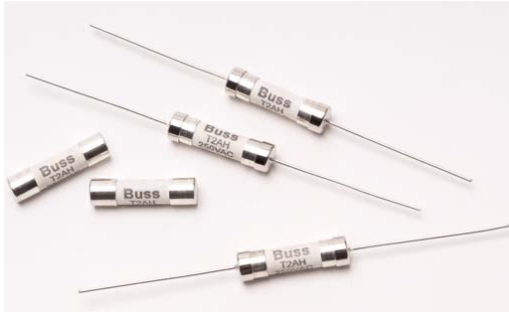

Product features

- 400 Vdc/500-600 Vac rating
- Time-delay, high breaking capacity
- 5 mm x 20 mm physical size
- Ceramic tube with plated end cap construction
- Designed to IEC 60127-2, Standard, Sheet 5
- RoHS Compliant, lead free and halogen free
- Optional axial leads available

Electrical Characteristics								
Amps	1.5I _n	2.1I _n	2.75I _n		4I _n		10I _n	
	Min min.	Max min.	Min ms	Max s	Min ms	Max s	Min ms	Max ms
<1A	>60	<30	>250	<80	>50	<5	>5	<150
1A-3.15A	>60	<30	>750	<80	>95	<5	>10	<150
4A-6.3A	>60	<30	>750	<80	>150	<5	>10	<150
8A-10A	>30	<30	>750	<80	>150	<5	>10	<150

Specifications

Catalog Number	Voltage Rating Vac	Max. Voltage Rating		Interrupting Rating (A) Under			Typical DC Cold Resistance Ω ³	Typical Voltage Drop (mV) ⁴	Typical Value I ² t (A ² s) ⁵	Agency Approvals					
		AC	DC	250 Vac	Max Volts	400 Vdc				250Vac					
		TUV	CQC	CCC	PSE/JET	cURus ⁷									
S505H-500-R	250	600	400	1500	100	1500	0.507	295	0.188						x
S505H-800-R	250	600	400	1500	100	1500	0.237	189	0.632						x
S505H-1-R	250	600	400	1500	100	1500	0.14	153	1.28				X		x
S505H-1.25-R	250	600	400	1500	100	1500	0.108	150	2.22				X		x
S505H-1.6-R	250	600	400	1500	100	1500	0.07	125	6.78				X		x
S505H-2-R	250	600	400	1500	100	1500	0.055	128	11.44	X		X	X		x
S505H-2.5-R	250	600	400	1500	100	1500	0.04	126	24.23	X		X	X		x
S505H-3.15-R	250	600	400	1500	100	1500	0.031	121	43.55	X		X	X		x
S505H-4-R	250	600	400	1500	100	1500	0.019	90	38.45	X		X	X		x
S505H-5-R	250	600	400	1500	100	1500	0.015	89	71.3	X		X	X		x
S505H-6.3-R	250	500	400	1500	100	1500	0.011	80	111.4	X		X	X		x
S505H-8-R	250	500	400	1500	100	1500	0.007	76	228.2	X	X		X		x
S505H-10-R	250	500	400	1500	100	1500	0.006	72	349.5	X	X		X		x

1. Max. Voltage rating: Base on the breaking capacity test according to UL.
 2. - Breaking Capacity of 250 VAC/1500 A is tested by all agency approvals, test condition is 250 Vac, PF: 0.7-0.8.
 - Breaking Capacity of Max. voltage is tested by UL, PF:1.
 - Breaking Capacity Test of DC is tested by UL under Capacitor Bank 4800 mF (for 400 V, 1500 A), 2400 mF (for 400 V, 500 A).

3. Cold Resistance: Measure at <10% rated current.
 4. Typical Voltage Drop: Voltage drop is measured under ambient 20 °C with rated current
 5. Typical Pre-Arc I²t: Measured at 10In DC
 6. Does not apply to axial leaded versions.
 7. 600/500 Vac, 400 Vdc.

Applications

- Power supplies - adapters
- Desktops/notebooks
- TVs / Displays
- Set top boxes
- Lighting ballasts
- Battery chargers
- Printers
- Game systems
- Air conditioners

Agency information

S505H-XXX-R (Ferrule)

- cURus approval: Guide JFHR2, File E56412 and Guide JFHR8, File E56412
- CCC: 2A-4A, Cert. No.: 2010010207395946; 5A-6.3A Cert. No.: 2010010207390567
- CQC Approval: 8A-10A, Cert. No.: CQC10012043350
- TUV Approval: 2A-10A, Cert. No.: R50172128
- PSE Approval: 1A-5A, Cert. No.: JET1641-31003-1009; 6.3A-10A, Cert. No: JET1641-31003-1011

S505H-V-XXX-R (Axial Leads)

- PSE Approval: 1A-5A, Cert. No.: JET1641-31003-1010; 6.3A-10A, Cert. No: JET1641-31003-1012
- cURus approval: Guide JFHR2, File E56412 and Guide JFHR8, File E56412



Powering Business Worldwide

Dimensions - mm

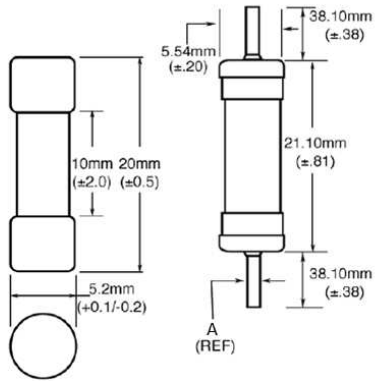

Construction

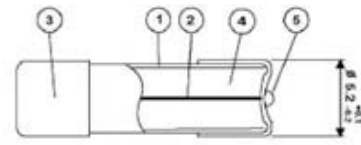

500-800mA

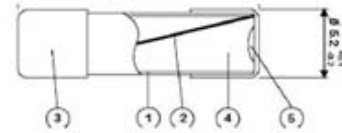

1-1.6 Amps

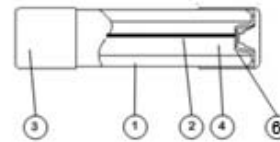

2 Amps & Above

1. Ceramic Tube
2. Wire Fuse Element
3. Plated Fuse Cap
4. Filler
5. Solder
6. Eyelet

Time-Current Curves

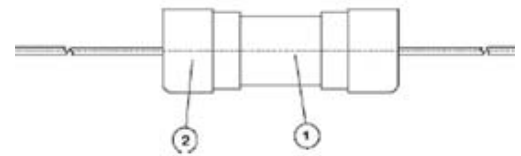
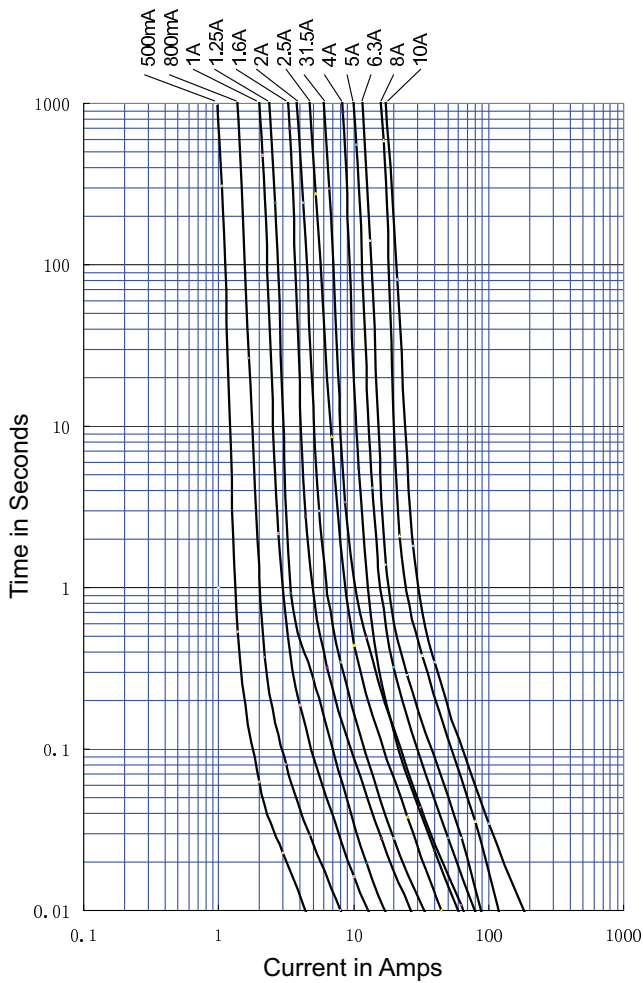

Axial Leaded Versions

1. S505H-XXX-R
2. Axial Leaded Cap

Wave Soldering Parameters

Note: These devices are NOT recommended for IR or convection reflow processes.

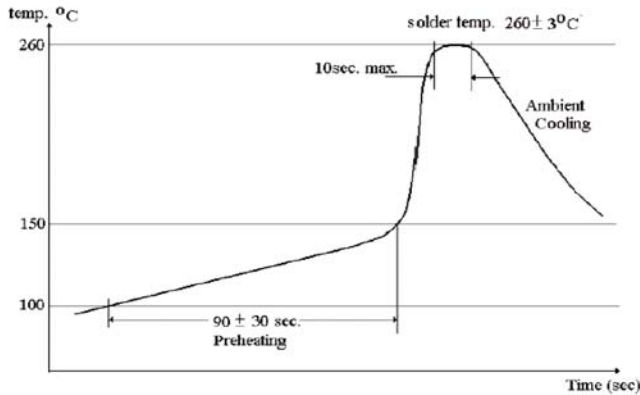

- Reservoir Temperature: $260^{\circ}\text{C} \pm 3^{\circ}\text{C}$
- Soldering Time: 10 seconds max.

Recommended Hand Solder Parameters

- Soldering Iron Tip Temperature: $350^{\circ}\text{C} \pm 5^{\circ}\text{C}$
- Heating Time: 5 seconds max.

Operating Temperature Range

- -40°C to $+85^{\circ}\text{C}$ (see temperature derating curve below for percentage of fuse rating per ambient temperature)

Temperature Derating Curve

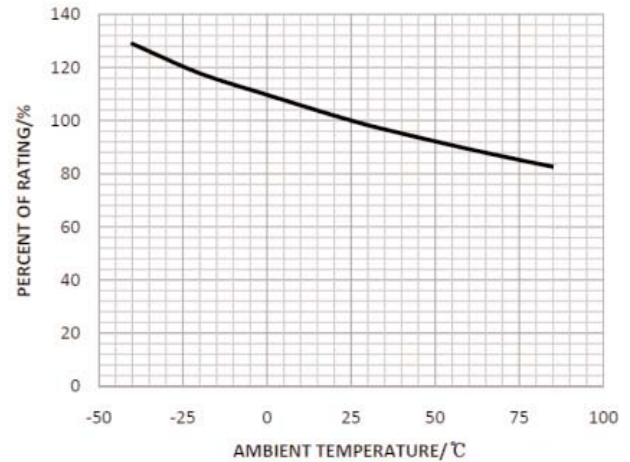

Packaging Code	
Packaging Code Prefix	Description
BK-	100 fuses packed into a cardboard carton with flaps folded
BK1-	1000 fuses packed into a poly bag
TR2-	1500 axial leaded fuses on tape and reel
Option Code	
Option Code	Description
-V	Axial leads – copper tinned wire with nickel plated brass end caps
-R	RoHS compliant version

Life Support Policy: Eaton does not authorize the use of any of its products for use in life support devices or systems without the express written approval of an officer of the Company. Life support systems are devices which support or sustain life, and whose failure to perform, when properly used in accordance with instructions for use provided in the labeling, can be reasonably expected to result in significant injury to the user.

Eaton reserves the right, without notice, to change design or construction of any products and to discontinue or limit distribution of any products. Eaton also reserves the right to change or update, without notice, any technical information contained in this bulletin.

Eaton
Electronics Division
1000 Eaton Boulevard
Cleveland, OH 44122
United States
www.eaton.com/electronics

© 2017 Eaton
All Rights Reserved
Printed in USA
Publication No. 4406 BU-SB11276
June 2017