

阅读申明

- 1.本站收集的数据手册和产品资料都来自互联网，版权归原作者所有。如读者和版权方有任何异议请及时告之，我们将妥善解决。
- 2.本站提供的中文数据手册是英文数据手册的中文翻译，其目的是协助用户阅读，该译文无法自动跟随原稿更新，同时也可能存在翻译上的不当。建议读者以英文原稿为参考以便获得更精准的信息。
- 3.本站提供的产品资料，来自厂商的技术支持或者使用者的心得体会等，其内容可能存在描述上的差异，建议读者做出适当判断。
- 4.如需与我们联系，请发邮件到marketing@iczoom.com，主题请标有“数据手册”字样。

Read Statement

1. The datasheets and other product information on the site are all from network reference or other public materials, and the copyright belongs to the original author and original published source. If readers and copyright owners have any objections, please contact us and we will deal with it in a timely manner.
2. The Chinese datasheets provided on the website is a Chinese translation of the English datasheets. Its purpose is for reader's learning exchange only and do not involve commercial purposes. The translation cannot be automatically updated with the original manuscript, and there may also be improper translations. Readers are advised to use the English manuscript as a reference for more accurate information.
3. All product information provided on the website refer to solutions from manufacturers' technical support or users the contents may have differences in description, and readers are advised to take the original article as the standard.
4. If you have any questions, please contact us at marketing@iczoom.com and mark the subject with "Datasheets" .

224/225 Series Lead-Free 2AG, Fast-Acting

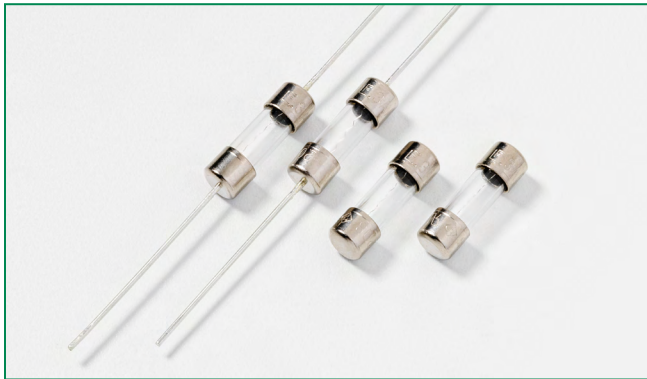





Description

The 2AG Fast-Acting Fuses are available in cartridge form or with axial leads. 2AG Fuses provide the same performance characteristics as their 3AG counterpart, while occupying one-third the space. Sleeved fuses are available.

Features

- In accordance with Underwriter's Laboratories Standard UL 248-14
- Available in cartridge and axial lead form and with various forming dimensions
- RoHS compliant and Lead-free

Agency Approvals

Agency	Agency File Number	Ampere Range
	E10480	0.375A - 3.5A
	E10480	4A - 10A
	29862	0.375A - 10A
	NBK200405-E10480A/B/C/D NBK110512-E10480A/B NBK210405-E10480E/F	1A - 3.5A 4A - 5A 6A - 10A
	N/A	0.375A - 10A

Applications

Used as supplementary protection in appliance or utilization equipment to provide individual protection for components or internal circuits.

Electrical Characteristics for Series

% of Ampere Rating	Opening Time
100%	4 hours, Minimum
135%	1 hour, Maximum
200%	1 sec., Maximum

Additional Information



**Datasheet
224 Series**



**Resources
224 Series**



**Samples
224 Series**



**Datasheet
225 Series**



**Resources
225 Series**







**Samples
225 Series**



**Accessories
224 & 225 Series**

For recommended fuse accessories for this product series, see ['Recommended Accessories'](#) section.

Electrical Characteristic Specifications by Item

Amp Code	Ampere Rating (A)	Voltage Rating (V)	Interrupting Rating	Nominal Cold Resistance (Ohms)	Nominal Melting I ² t (A ² sec)	Agency Approvals				
										
.375	0.375	250	35A@250Vac 10KA@125Vac 10KA@125Vdc	0.3950	0.171	x		x		x
.500	0.5	250		0.2650	0.365	x		x		x
.750	0.75	250		0.1520	1.050	x		x		x
001.	1	250		0.1027	2.220	x		x	x	x
01.5	1.5	250	0.0712	0.800	x		x	x	x	
002.	2	250	0.0497	2.180	x		x	x	x	
02.5	2.5	250	0.0372	3.820	x		x	x	x	
003.	3	250	0.0317	4.620	x		x	x	x	
03.5	3.5	250	0.0265	6.700	x		x	x	x	
004.	4	125	100A@250Vac 500A@125Vac	0.0240	9.400		x	x	x	x
005.	5	125		0.0186	17.0		x	x	x	x
005.	5	250		0.0186	17.0		x	x		x
006.	6	125	500A@125Vac	0.0154	22.1		x	x	x	x
007.	7	125		0.0130	40.0		x	x	x	x
008.	8	125		0.0107	56.0		x	x	x	x
010.	10	125		0.0075	116.0		x	x	x	x

* 10A with 500A @ 125 Vdc internal breaking capacity testing.

Temperature Re-rating Curve

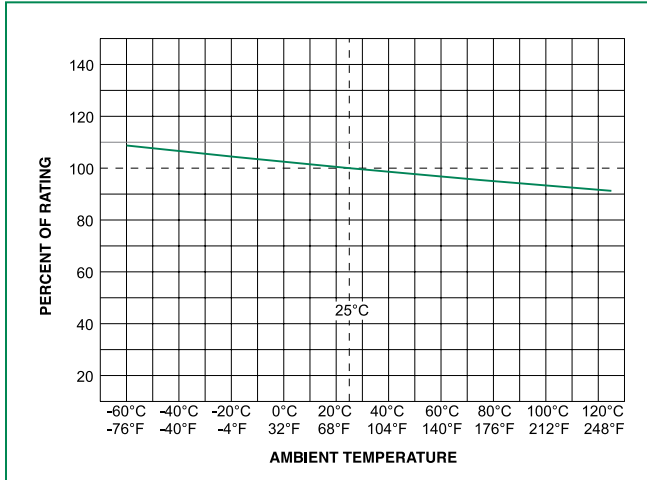

Note:
 Rerating depicted in this curve is in addition to the standard derating of 25% for continuous operation.

Average Time Current Curves

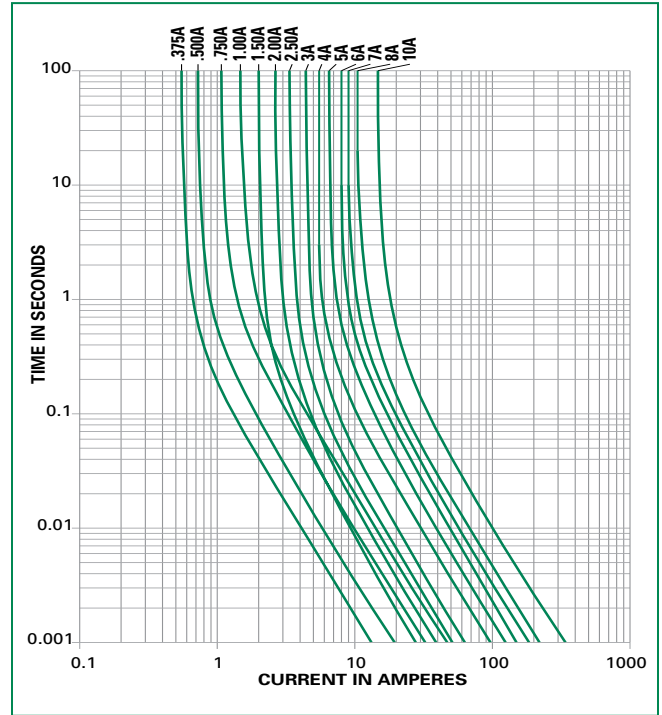

Soldering Parameters - Wave Soldering

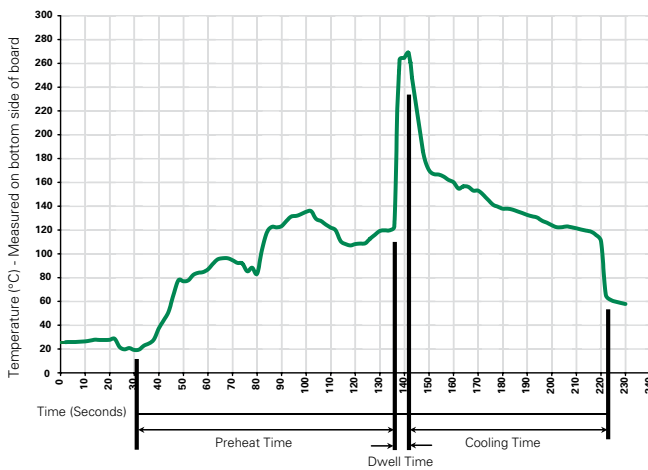

Recommended Process Parameters:

Wave Parameter	Lead-Free Recommendation
Preheat: (Depends on Flux Activation Temperature) (Typical Industry Recommendation)	
Temperature Minimum:	100°C
Temperature Maximum:	150°C
Preheat Time:	60-180 seconds
Solder Pot Temperature:	260°C Maximum
Solder Dwell Time:	2-5 seconds

Recommended Hand-Solder Parameters:

Solder Iron Temperature: 350°C +/- 5°C
 Heating Time: 5 seconds max.

Note: These devices are not recommended for IR or Convection Reflow process.

Product Characteristics

Materials	Body : Glass Cap : Nickel-plated brass Leads: Tin-plated Copper
Terminal Strength	MIL-STD-202, Method 211, Test Condition A
Solderability	MIL-STD-202 Method 208
Product Marking	Cap1 : Brand logo, current and voltage ratings Cap2 : Series and agency approval marks

Operating Temperature:	-55°C to 125°C.
Thermal Shock:	MIL-STD-202, Method 107, Test Condition B (5 Cycles -65°C to +125°C).
Vibration	MIL-STD-202, Method 201
Humidity	MIL-STD-202, Method 103, Test Condition A: High RH (95%) and elevated temp (40°C) for 240 hours
Salt Spray	MIL-STD-202, Method 101, Test Condition B

Dimensions

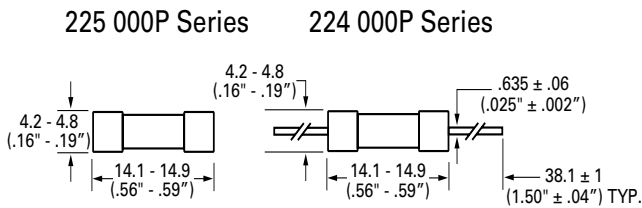

Part Numbering System

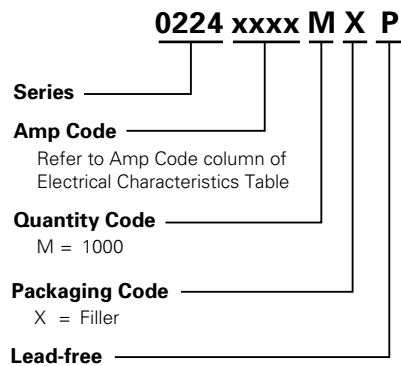

Note: The ratings from 4A to 10A with MXUP in the suffix

Packaging

Packaging Option	Packaging Specification	Quantity	Quantity & Packaging Code	Taping Width
224 Series				
Bulk	N/A	1000	MX	N/A
Bulk	N/A	100	HX	N/A
Reel and Tape	EIA 296-E	1500	DRT1	T1=53mm (2.087")
225 Series				
Bulk	N/A	1000	MX	N/A
Bulk	N/A	100	HX	N/A

Recommended Accessories

Accessory Type	Series	Description	Max Application Voltage	Max Application Amperage
Holder	245	Panel Mount Shock-Safe Fuseholder	300	10
	150	In-Line Fuseholder	350	10
	286	Panel Mount Flip-Top Shock-Safe Fuseholder	250	10
Block	254	OMNI-BLOK® Fuse Block	400	10
Clip	111	PC Board Mount Fuse Clip	250	10

- Notes:
- Do not use in applications above rating.
 - Please refer to fuseholder data sheet for specific re-rating information.
 - Please contact factory for applications greater than the max voltage and amperage shown.