

阅读申明

- 1.本站收集的数据手册和产品资料都来自互联网，版权归原作者所有。如读者和版权方有任何异议请及时告之，我们将妥善解决。
- 2.本站提供的中文数据手册是英文数据手册的中文翻译，其目的是协助用户阅读，该译文无法自动跟随原稿更新，同时也可能存在翻译上的不当。建议读者以英文原稿为参考以便获得更精准的信息。
- 3.本站提供的产品资料，来自厂商的技术支持或者使用者的心得体会等，其内容可能存在描述上的差异，建议读者做出适当判断。
- 4.如需与我们联系，请发邮件到marketing@iczoom.com，主题请标有“数据手册”字样。







Read Statement

1. The datasheets and other product information on the site are all from network reference or other public materials, and the copyright belongs to the original author and original published source. If readers and copyright owners have any objections, please contact us and we will deal with it in a timely manner.
2. The Chinese datasheets provided on the website is a Chinese translation of the English datasheets. Its purpose is for reader's learning exchange only and do not involve commercial purposes. The translation cannot be automatically updated with the original manuscript, and there may also be improper translations. Readers are advised to use the English manuscript as a reference for more accurate information.
3. All product information provided on the website refer to solutions from manufacturers' technical support or users the contents may have differences in description, and readers are advised to take the original article as the standard.
4. If you have any questions, please contact us at marketing@iczoom.com and mark the subject with "Datasheets" .

325/326 Series Lead-Free 3AB, Slo-Blo® Fuse



Agency Approvals

Agency	Agency File Number	Ampere Range
	E10480	0.250A - 10A
	E10480	12A - 30A
	29862	0.250A - 30A
	Cartridge: NBK 030805-E10480A NBK 030805-E10480C NBK 030805-E10480E NBK 260106-JP1021A Leaded: NBK 030805-E10480B NBK 030805-E10480D NBK 030805-E10480F NBK 260106-JP1021B	1A-3.2A 4A-5A 6.25A-15A 20A-30A 1A-3.2A 4A-5A 6.25A-15A 20A-30A
	SU05001-5010 SU05001-5011 SU05001-5012 SU05001-6006 SU05001-6007	7-10A 12A, 15A 20A 2.8A-3.2A 2.5A
	T 50239752 01	*12A/*15A/*20A
	N/A	0.010A - 30A

* Approved for cartridge version only

Description

The 3AB Slo-Blo® Fuse with ceramic body construction permits higher interrupting ratings and voltage ratings. Ideal for applications where high current loads are expected.

Features

- In accordance with UL Standard 248-14
- Available in cartridge and axial lead format and with various forming dimensions
- RoHS compliant and Lead-free

Applications

Used as supplementary protection in appliance or utilization equipment to provide individual protection for components or internal circuits.

Electrical Characteristics for Series

% of Ampere Rating	Ampere Rating	Opening Time
100%	0.010A – 30A	4 hours, Minimum
135%	0.010A – 30A	1 hour, Maximum
200%	0.010A – 3.2A	5 sec., Min., 30 sec., Max.
	4A – 30A	5 sec., Min., 60 sec., Max.

Additional Information



Datasheet
325 Series



Resources
325 Series



Samples
325 Series



Accessories
325 Series



Datasheet
326 Series



Resources
326 Series









Samples
326 Series



Accessories
326 Series

For recommended fuse accessories for this product series, see '[Recommended Accessories](#)' section.

Electrical Characteristic Specifications by Item

Amp Code	Ampere Rating (A)	Voltage Rating (V)	Interrupting Rating	Nominal Cold Resistance (Ohms)	Nominal Melting I ² t (A ² sec)	Agency Approvals								
														
.010	0.01	250	100A@250Vac	3324.8000	0.00013						x			
.031	0.031	250		332.5000	0.0110							x		
.062	0.062	250		91.7000	0.0276							x		
.100	0.1	250		33.5500	0.0870							x		
.125	0.125	250		22.4500	0.100							x		
.150	0.15	250		15.4500	0.143							x		
.175	0.175	250		8.9200	0.350							x		
.187	0.187	250		7.7250	0.330							x		
.200	0.2	250		6.7700	0.316							x		
.250	0.25	250		4.4300	0.804				x	x	x			
.300	0.3	250	3.2200	1.230				x	x	x				
.375	0.375	250	2.1550	1.20				x	x	x				
.400	0.4	250	1.9350	1.33				x	x	x				
.500	0.5	250	1.3000	4.80				x	x	x				
.600	0.6	250	0.9495	3.90				x	x	x				
.700	0.7	250	0.7215	6.42				x	x	x				
.750	0.75	250	0.6410	13.00				x	x	x				
.800	0.8	250	0.5725	8.20				x	x	x				
001.	1	250	100A@250Vac 10KA@125Vac 10KA@125Vdc	0.3890	16.3	x		x	x	x				
01.2	1.2	250		0.2860	22.0	x		x	x	x				
1.25	1.25	250		0.2680	40.0	x		x	x	x				
01.5	1.5	250		0.1975	59.7	x		x	x	x				
01.6	1.6	250		0.1760	66.0	x		x	x	x				
002.	2	250		0.1210	118.0	x		x	x	x				
02.5	2.5	250		0.0835	185.0	x		x	x	x			x	
02.8	2.8	250		0.0695	232.0	x		x	x	x			x	
003.	3	250		0.0605	200.0	x		x	x	x			x	
03.2	3.2	250		100A@250Vac 10KA@125Vac	0.0539	214.0	x		x	x	x			x
004.	4	250	400A@250Vac 10KA@125Vac 10KA@125Vdc	0.0761	9.71	x		x	x	x				
005.	5	250		0.0522	25.0	x		x	x	x				
6.25	6.25	250		0.0346	60.4	x		x	x	x				
007.	7	250		0.0227	47.3	x		x	x	x			x	
008.	8	250		0.0193	67.1	x		x	x	x			x	
010.	10	250	0.0132	137	x		x	x	x			x		
012.	12	250	400A@250Vac 10KA@125Vac 600A@125Vdc	0.0067	129	x	x	x		x	x***		x	
012.*	12	250	1500A@250Vac	0.0011	618		x	x		x				
015.	15	250	400A@250Vac 10KA@125Vac 600A@125Vdc	0.0050	245	x	x	x		x	x***		x	
015.*	15	250	1500A@250Vac	0.0083	760		x	x		x				
020.	20	250	400A@250Vac 10KA@125Vac 600A@125Vdc	0.0034	575	x	x	x		x	x***		x	
020.*	20	250	1500A@250Vac	0.0042	2500		x	x		x				
025.**	25	250	1500A@250Vac	0.0032	4682		x			x				
025.	25	250	400A@250Vac 10KA@60Vdc	0.0024	1030	x	x	x		x				
030.	30	250	600A@125Vdc	0.0019	1690	x	x	x		x				

*Higher I²t version available. Please add suffix "D" to part numbers. For instance, 0325020.MXDP, 0326020.MXDP
I²t test at 10x rated current.

**Higher I²t version available. Please add suffix "W" to part numbers. For instance, 0325025.MXWP

***Approved for cartridge versions only, and interrupting rating is 400A@125Vac and 400A@250Vac

© 2016 Littelfuse, Inc.

Specifications are subject to change without notice.

Revised: 12/16/16

Temperature Re-rating Curve

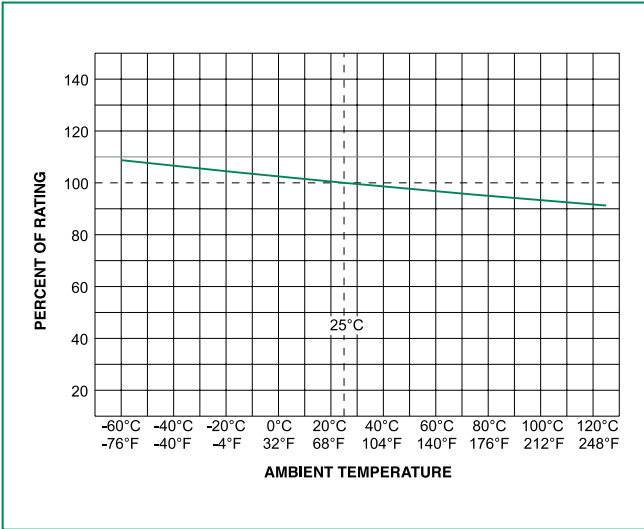

Note:
Rerating depicted in this curve is in addition to the standard derating of 25% for continuous operation.

Average Time Current Curves

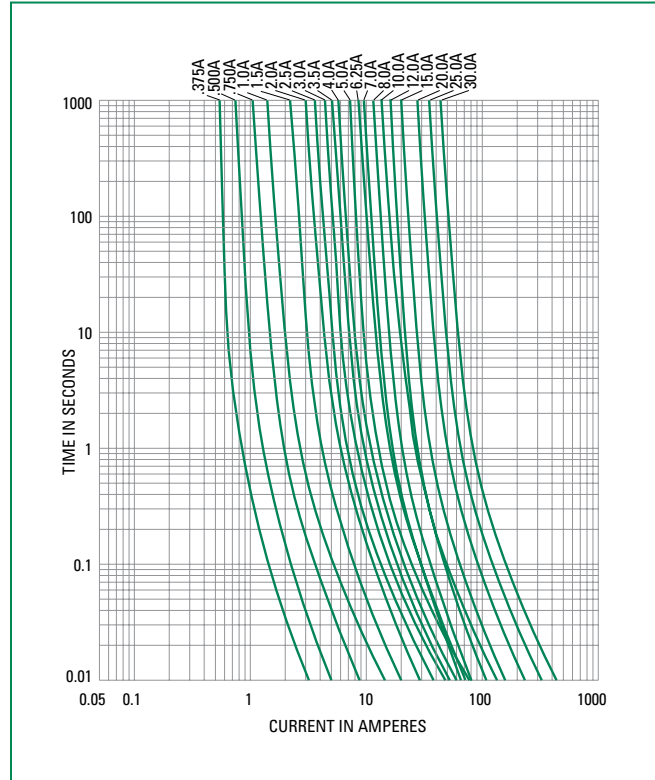

Soldering Parameters - Wave Soldering

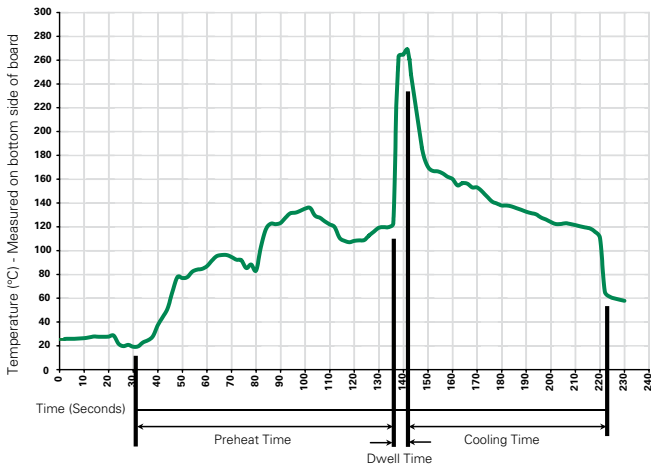

Recommended Process Parameters:

Wave Parameter	Lead-Free Recommendation
Preheat: (Depends on Flux Activation Temperature) (Typical Industry Recommendation)	
Temperature Minimum:	100°C
Temperature Maximum:	150°C
Preheat Time:	60-180 seconds
Solder Pot Temperature:	260°C Maximum
Solder Dwell Time:	2-5 seconds

Recommended Hand-Solder Parameters:

Solder Iron Temperature: 350°C +/- 5°C
Heating Time: 5 seconds max.

Note: These devices are not recommended for IR or Convection Reflow process.

Product Characteristics

Materials	Body: Ceramic Cap: Nickel-plated brass Leads: Tin-plated Copper
Terminal Strength	MIL-STD-202, Method 211, Test Condition A
Solderability	MIL-STD-202 Method 208
Product Marking	Cap1: Brand logo, current and voltage ratings Cap2: Series and agency approval marks

Operating Temperature	-55°C to +125°C
Thermal Shock	MIL-STD-202, Method 107, Test Condition B:(5 cycles - 65°C to 125°C)
Vibration:	MIL-STD-202, Method 201
Humidity	MIL-STD-202, Method 103, Test Condition A: High RH (95%) and Elevated temperature(40°C) for 240 hours
Salt Spray	MIL-STD-202, Method 101, Test Condition B

Dimensions

Measurements displayed in millimeters (inches)

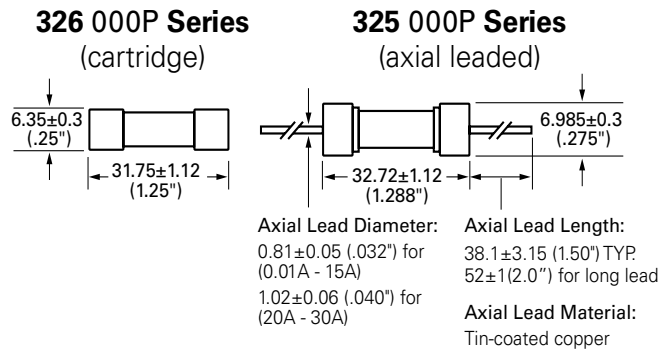

Part Numbering System

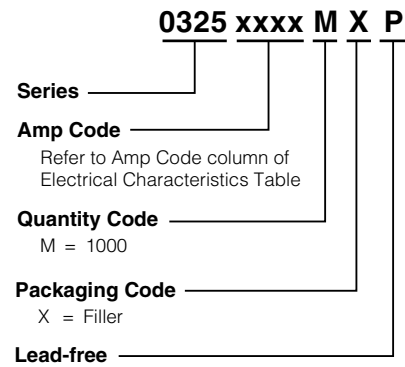

Packaging

Packaging Option	Packaging Specification	Quantity	Quantity & Packaging Code	Taping Width
325 Series				
Bulk	N/A	5	VX	N/A
Bulk	N/A	100	HX	N/A
Bulk	N/A	1000	MX	N/A
Bulk	N/A	1000	MX52 (long lead)	N/A
Bulk	N/A	1000	MX52L (long lead)	N/A
Bulk	N/A	1000	MXD	N/A
Bulk	N/A	1000	MXF31	N/A
Bulk	N/A	1000	MXW	N/A
326 Series				
Bulk	N/A	5	VX	N/A
Bulk	N/A	100	HX	N/A
Bulk	N/A	1000	MX	N/A
Bulk	N/A	1000	MXCC	N/A
Bulk	N/A	1000	MXD	N/A

Recommended Accessories

Accessory Type	Series	Description	Max Application Voltage	Max Application Amperage
Holder	155100	Twist-Lock In-Line Fuseholder	32	20
	342	Traditional Panel Mount Fuseholder	250	20
	346	Panel Mount Flip-Top Shock-Safe Fuseholder	250	15
	345	Shock-Safe Fuseholder with PC Mount, Solder Mount and Panel Mount options	250	20
Block	354	Low Profile OMNI-BLOK® Fuse Block	600	30
	359	High Current Screw Terminal Fuse Block		30
Clip	122	High Current Traditional PC Board Fuse Clip	1000	30
	101	Rivet/Eyelet Type Fuse Clip	1000	15

- Notes:
1. Do not use in applications above rating.
 2. Please refer to fuseholder data sheet for specific re-rating information.
 3. Please contact Littelfuse for applications greater than the max voltage and amperage shown.