

阅读申明

- 1.本站收集的数据手册和产品资料都来自互联网，版权归原作者所有。如读者和版权方有任何异议请及时告之，我们将妥善解决。
- 2.本站提供的中文数据手册是英文数据手册的中文翻译，其目的是协助用户阅读，该译文无法自动跟随原稿更新，同时也可能存在翻译上的不当。建议读者以英文原稿为参考以便获得更精准的信息。
- 3.本站提供的产品资料，来自厂商的技术支持或者使用者的心得体会等，其内容可能存在描述上的差异，建议读者做出适当判断。
- 4.如需与我们联系，请发邮件到marketing@iczoom.com，主题请标有“数据手册”字样。

Read Statement

1. The datasheets and other product information on the site are all from network reference or other public materials, and the copyright belongs to the original author and original published source. If readers and copyright owners have any objections, please contact us and we will deal with it in a timely manner.
2. The Chinese datasheets provided on the website is a Chinese translation of the English datasheets. Its purpose is for reader's learning exchange only and do not involve commercial purposes. The translation cannot be automatically updated with the original manuscript, and there may also be improper translations. Readers are advised to use the English manuscript as a reference for more accurate information.
3. All product information provided on the website refer to solutions from manufacturers' technical support or users the contents may have differences in description, and readers are advised to take the original article as the standard.
4. If you have any questions, please contact us at marketing@iczoom.com and mark the subject with "Datasheets" .

400 Series, TE5®, Time-Lag Fuse

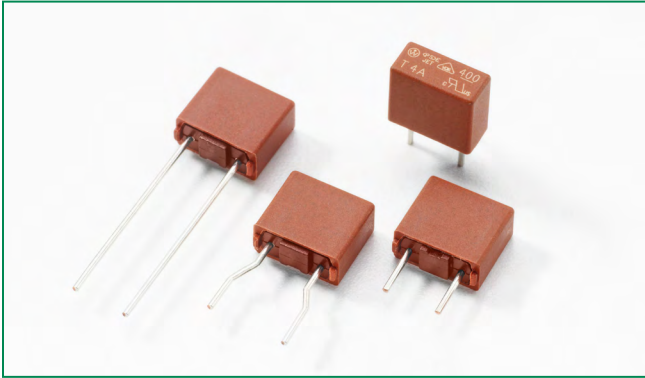

Description

The 400 Series is a TE5®, Time-Lag type subminiature fuse designed for overcurrent protection. It is 250V rated and designed in accordance to IEC 60127-3.

Features

- Lead-free and RoHS Compliant
- Reduced PCB space requirements
- Direct solderable or plug-in versions
- Low internal resistance
- Shock safe casing
- Vibration resistant
- Halogen-free

Applications

- Battery chargers
- Consumer electronics
- Power supplies
- Industrial controllers

Additional Information



Datasheet







Resources



Samples





Agency Approvals

Agency	Agency File Number	Ampere Range
	E67006	800mA – 6.3A
	JET1896-31007-2001 JET1896-31007-1003	1A – 5A 6.3A
	DE1-40597	500mA – 6.3A
	CQC09012031624	500mA – 6.3A
	SUS05024-9004	500mA – 800mA
	SUS05024-9003	1A – 2.5A
	SUS05024-9001	3.15A
	SUS05024-10003	4A – 5A
	SUS05024-9002	6.3A

Electrical Characteristics

% of Ampere Rating	Opening Time
150%	1 Hour, Minimum
210%	120 Secs., Maximum
275%	400 ms, Minimum; 10 Secs., Maximum
400%	150 ms, Minimum; 3 Secs., Maximum
1000%	20 ms, Minimum; 150 ms, Maximum

Electrical Characteristics

Amp Code	Rated Current	Rated Voltage	Breaking Capacity	Voltage Drop 1.0×I _N max. (mV)	Power Dissipation 1.0×I _N max. (mW)	Melting Integral 10×I _N max. (A ² s)	Agency Approvals				
											
0500	500mA	250V	130A/250VAC* 50-60 Hz cosφ = 1.0	165	297	2.17	x		x	x	x
0800	800mA	250V		116	387	6.72	x		x	x	x
1100	1.00A	250V		89	432	9.63	x	x	x	x	x
1125	1.25A	250V		76	411	14.44	x	x	x	x	x
1160	1.60A	250V		76	601	21.75	x	x	x	x	x
1200	2.00A	250V		75	758	32.16	x	x	x	x	x
1250	2.50A	250V		61	683	61.94	x	x	x	x	x
1315	3.15A	250V		55	921	101.61	x	x	x	x	x
1400	4.00A	250V		65	936	133.40	x	x	x	x	x
1500	5.00A	250V		56	948	216.50	x	x	x	x	x
1630	6.30A	250V		48	926	318.71	x	x	x	x	x

* Per VDE, approved breaking capacity is at 100A, 250VAC

Temperature Derating Curve

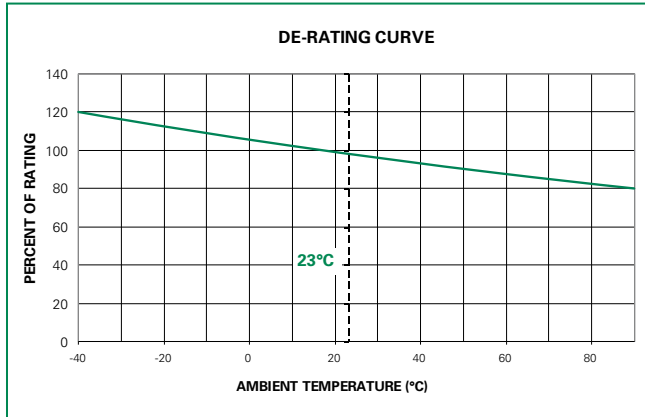

Average Time Current Curves

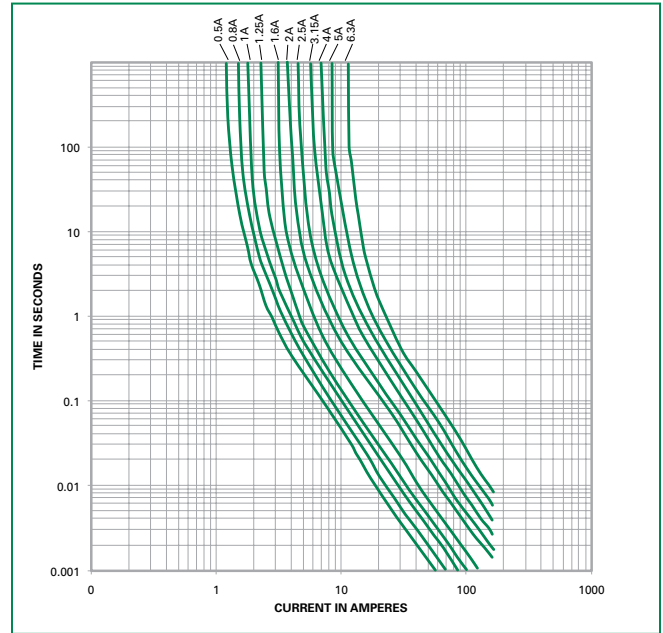

Soldering Parameters - Wave Soldering

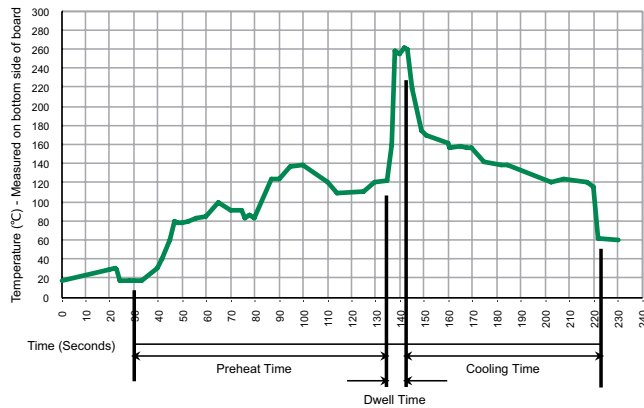

Recommended Process Parameters:

Wave Parameter	Lead-Free Recommendation
Preheat: (Depends on Flux Activation Temperature)	(Typical Industry Recommendation)
Temperature Minimum:	100° C
Temperature Maximum:	150° C
Preheat Time:	60-180 seconds
Solder Pot Temperature:	260° C Maximum
Solder Dwell Time:	2-5 seconds

Recommended Hand-Solder Parameters:

Solder Iron Temperature: 350° C +/- 5° C
 Heating Time: 5 seconds max.

Note: These devices are not recommended for IR or Convection Reflow process.

Product Characteristics

Materials	Base/Cap: Brown Thermoplastic Polyamide, UL 94 V-0 Round Pins: Copper, Tin-plated
Lead Pull Strength	10 N (IEC 60068-2-21)
Solderability	260°C, ≤ 3s. (Wave) 350°C, ≤ 1s. (Soldering Iron)
Soldering Heat Resistance	260°C, 10s. (IEC 60068-2-20) 350°C, 3s. (Soldering Iron)

Operating Temperature	-40°C to +85°C (consider derating)
Climatic Category	-40°C to +85°C/21 days (EN 60068-1, -2-1, -2-2, -2-78)
Stock Conditions	+10°C to +60°C relative humidity 75% yearly average, without dew, maximum value for 30 days - 95%
Vibration Resistance	24 cycles at 15 min. each (EN60028-2-6) 10-60 Hz at 0.75 mm amplitude 20-2000 Hz at 10 g acceleration

Dimensions

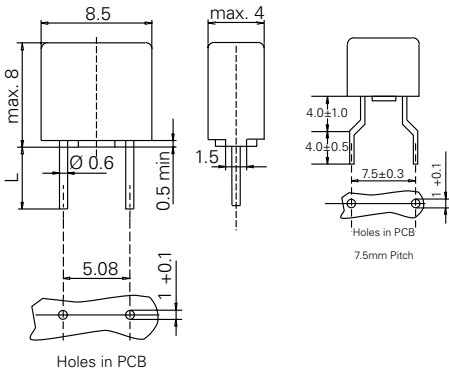

Long Leads (L=18.8±0.3mm)
Short Leads (L=4.3±0.3mm)

Part Numbering System

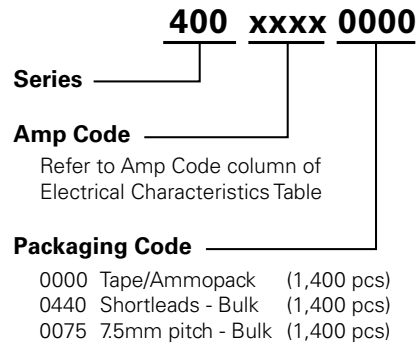

Packaging

Packaging Option	Packaging Specification	Quantity	Quantity & Packaging Code	Taping Width
400 Series				
Tape & Ammopack	N/A	1,400	0000	N/A
Short Leads	N/A	1,400	0440	N/A
7.5 mm Pitch	N/A	1,400	0075	N/A