

阅读申明

- 1.本站收集的数据手册和产品资料都来自互联网，版权归原作者所有。如读者和版权方有任何异议请及时告之，我们将妥善解决。
- 2.本站提供的中文数据手册是英文数据手册的中文翻译，其目的是协助用户阅读，该译文无法自动跟随原稿更新，同时也可能存在翻译上的不当。建议读者以英文原稿为参考以便获得更精准的信息。
- 3.本站提供的产品资料，来自厂商的技术支持或者使用者的心得体会等，其内容可能存在描述上的差异，建议读者做出适当判断。
- 4.如需与我们联系，请发邮件到marketing@iczoom.com，主题请标有“数据手册”字样。



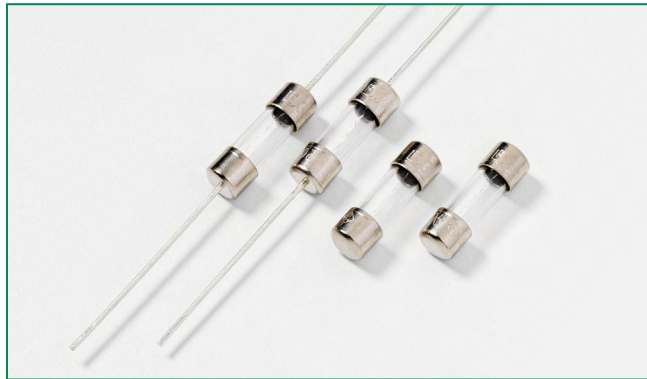

Read Statement

1. The datasheets and other product information on the site are all from network reference or other public materials, and the copyright belongs to the original author and original published source. If readers and copyright owners have any objections, please contact us and we will deal with it in a timely manner.
2. The Chinese datasheets provided on the website is a Chinese translation of the English datasheets. Its purpose is for reader's learning exchange only and do not involve commercial purposes. The translation cannot be automatically updated with the original manuscript, and there may also be improper translations. Readers are advised to use the English manuscript as a reference for more accurate information.
3. All product information provided on the website refer to solutions from manufacturers' technical support or users the contents may have differences in description, and readers are advised to take the original article as the standard.
4. If you have any questions, please contact us at marketing@iczoom.com and mark the subject with "Datasheets" .

229/230 Series 2AG, Slo-Blo® Fuse with Indicating Option



Agency Approvals

| Agency | Agency File Number | Ampere Range |
|---|---|---------------------------------|
|  | E10480 | 0.250A - 3.5A |
|  | 29862 | 0.250A - 7A |
|  | E10480 | 4A - 7A |
|  | NBK200405 - E10480C/D NBK110512 - E10480A/B NBK210405 - E10480E/F | 1A - 3.5A 4A - 5A 6A - 7A |
|  | N/A | 0.250A - 7A |

Electrical Characteristics for Series

| % of Ampere Rating | Opening Time |
|--------------------|---------------------|
| 100% | 4 hours, Minimum |
| 135% | 1 hour, Maximum |
| 200% | 3 seconds, Minimum |
| | 20 seconds, Maximum |

Description

Littelfuse 229/230 series Slo-Blo® Fuses are available in 2AG size cartridge or axial lead form, offer tripped fuse indicating option, and offer features designed to meet rigorous Telecom industry requirements.

229/230 series product ordered with the tripped fuse indicating option show discoloration of the glass body immediately after trip. They offer the same performance characteristics as standard product, and help to reduce time locating the tripped fuse and troubleshooting circuit issues.

The 229/230 series 0.25A - 1.25A range combines conventional overcurrent protection with ability to withstand high current, short duration pulses which complies to short circuit requirements of UL 60950 for telephone equipment. Insulating sleeve option is also available. Please refer to the Surge Withstand Specifications section of this document for additional information.

Features

- Available in cartridge and axial lead form, and a wide range of lead forming dimension and packaging options
- In accordance with UL Standard 248-14
- RoHS compliant and Lead-free
- Tripped fuse indicating option (add suffix 'S' to part number)
- Fuses are available for board washable with the additional sealing process (add suffix 'A' to part number)
- Sleeved fuse option available (contact Littelfuse for additional information)

Additional Information



Datasheet
229 Series



Resources
229 Series



Samples
229 Series



Accessories
229 & 230 Series



Datasheet
230 Series



Resources
230 Series



Samples
230 Series

For recommended fuse accessories for this product series, see ['Recommended Accessories'](#) section.

Electrical Characteristic Specification by Item

| Amp Code | Ampere Rating (A) | Voltage Rating (V) | Interrupting Rating | Nominal Cold Resistance (Ohms) | Nominal Melting I ² t (A ² sec) | Agency Approvals | | | | |
|----------|-------------------|--------------------|---|---|---|------------------|----|------|----|----|
| | | | | | | UL | RU | PS E | SF | CE |
| .250 | 0.25 | 250 | 35A@250Vac 10KA@125Vac 10KA@125Vdc 80A@310Vac | 2.4300 | 0.339 | x | | | x | x |
| .350 | 0.35 | 250 | | 1.3100 | 0.640 | x | | | x | x |
| .375 | 0.375 | 250 | | 1.1685 | 0.820 | x | | | x | x |
| .500 | 0.5 | 250 | | 0.6935 | 1.64 | x | | | x | x |
| .600 | 0.6 | 250 | | 0.4805 | 1.75 | x | | | x | x |
| .750 | 0.75 | 250 | | 0.3430 | 2.95 | x | | | x | x |
| .800 | 0.8 | 250 | | 0.3060 | 3.45 | x | | | x | x |
| 001. | 1 | 250 | | 0.2120 | 5.64 | x | | x | x | x |
| 1.25 | 1.25 | 250 | 100A@250Vac 10KA@125Vac 10KA@125Vdc 80A@310Vac | 0.1460 | 16.8 | x | | x | x | x |
| 01.5 | 1.5 | 250 | | 0.1077 | 20.0 | x | | x | x | x |
| 002. | 2 | 250 | | 0.0698 | 30.0 | x | | x | x | x |
| 2.25 | 2.25 | 250 | | 0.0567 | 39.0 | x | | x | x | x |
| 02.5 | 2.5 | 250 | | 0.0502 | 50.0 | x | | x | x | x |
| 003. | 3 | 250 | | 0.0383 | 77.0 | x | | x | x | x |
| 03.5 | 3.5 | 250 | | 100A@250Vac 10KA@125Vac 10KA@125Vdc | 0.0312 | 110.0 | x | | x | x |
| 004. | 4 | 125 | 400A@125Vac 400A@125Vdc | 0.0258 | 148.0 | | x | x | x | x |
| 005. | 5 | 125 | | 0.0186 | 267 | | x | x | x | x |
| 006. | 6 | 125 | | 0.0141 | 380 | | x | x | x | x |
| 007. | 7 | 125 | | 0.0116 | 464 | | x | x | x | x |

Surge Withstand Specifications

Peak Withstand Current(I_p): These fuses will withstand 50 repetitions of a double exponential impulse wave having peak currents(I_p) and peak voltages as listed.

| Amp Code | Ampere Rating (A) | Interrupting Rating | Nominal Cold Resistance (Ohms) | Nominal Melting I ² t (A ² sec) | 10x160 μs 1500V | 10x560 μs 800V | 10x1000 μs 1000V |
|----------|-------------------|--|--------------------------------|---|--------------------|-------------------|---------------------|
| .250 | 0.25 | 60A@600Vac 40A@600Vac 7A@600Vac 2.2A@600Vac | 2.4300 | 0.339 | 23.0A | 16.6A | 12.4A |
| .350 | 0.35 | | 1.3100 | 0.640 | 34.0A | 25.8A | 19.3A |
| .375 | 0.375 | | 1.1685 | 0.820 | 40.0A | 25.4A | 19.0A |
| .500 | 0.5 | | 0.6935 | 1.64 | 60.0A | 37.7A | 28.2A |
| .600 | 0.6 | | 0.4805 | 1.75 | 71.0A | 47.2A | 35.3A |
| .750 | 0.75 | | 0.3430 | 2.95 | 91.0A | 65.5A | 49.0A |
| .800 | 0.8 | | 0.3060 | 3.45 | 104.0A | 68.9A | 51.6A |
| 001. | 1 | | 0.2120 | 5.64 | 130A | 88.6A | 66.3A |
| 1.25 | 1.25* | | 0.1460 | 16.8 | 162.0A | 118.1A | 100.0A |

* 500A peak, 2500V, 2x10 microseconds, 20 repetitions

Temperature Re-rating Curve

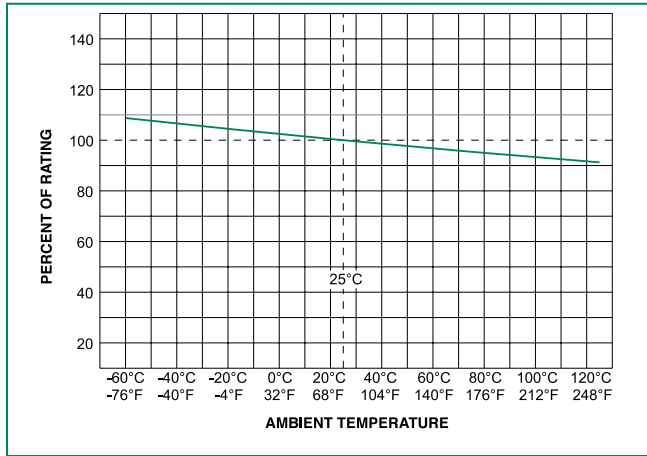

Note:
 Rerating depicted in this curve is in addition to the industry practice derating of 25% for continuous operation.

Average Time Current Curves

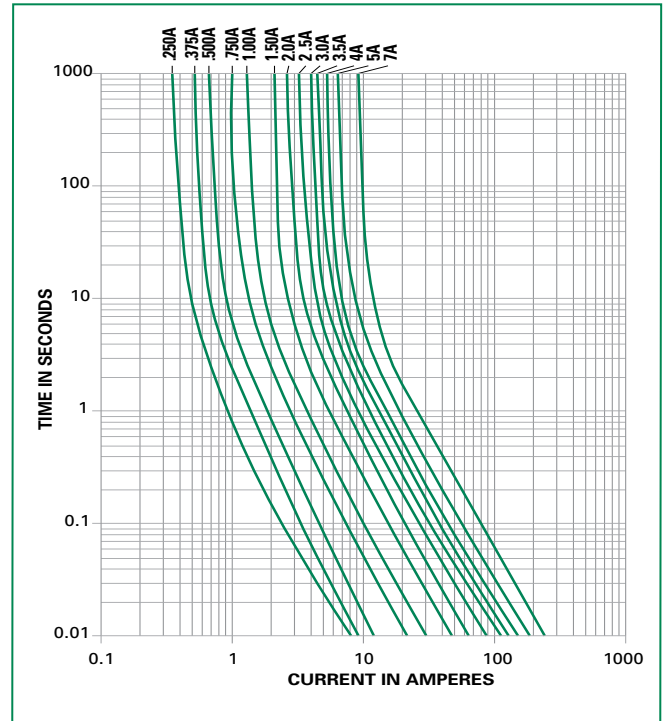

Soldering Parameters - Wave Soldering

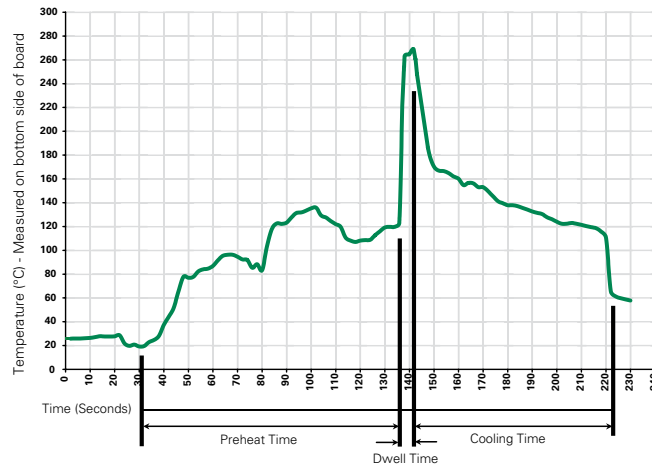

Recommended Process Parameters:

| Wave Parameter | Lead-Free Recommendation |
|---|-----------------------------------|
| Preheat: (Depends on Flux Activation Temperature) | (Typical Industry Recommendation) |
| Temperature Minimum: | 100°C |
| Temperature Maximum: | 150°C |
| Preheat Time: | 60-180 seconds |
| Solder Pot Temperature: | 260° C Maximum |
| Solder Dwell Time: | 2-5 seconds |

Recommended Hand-Solder Parameters:

Solder Iron Temperature: 350°C +/- 5°C
 Heating Time: 5 seconds max.

Note: These devices are not recommended for IR or Convection Reflow process.

Product Characteristics

| | |
|--------------------------|---|
| Materials | Body: Glass Cap: Nickel-plated brass Leads: Tin-plated Copper |
| Terminal Strength | MIL-STD-202, Method 211, Test Condition A |
| Solderability | MIL-STD-202 method 208 |
| Product Marking | Cap1: Brand logo, current and voltage ratings Cap2: Series and agency approval marks |

| | |
|------------------------------|--|
| Operating Temperature | -55°C to +125°C |
| Thermal Shock | MIL-STD-202, Method 107, Test Condition B: (5 cycles -65°C to 125°C) |
| Vibration | MIL-STD-202, Method 201 |
| Humidity | MIL-STD-202, Method 103, Test Condition A: High RH (95%) and Elevated temperature (40°C) for 240 hours |
| Salt Spray | MIL-STD-202, Method 101, Test Condition B |

Dimensions

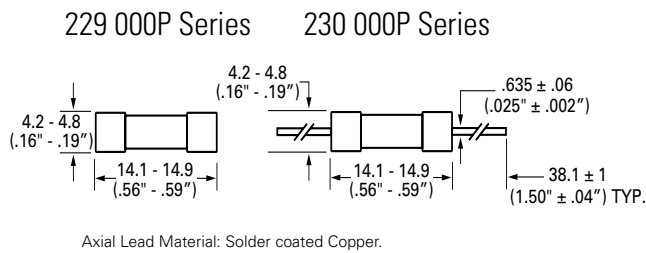

Part Numbering System

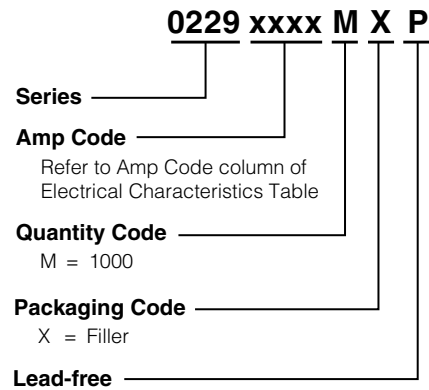

Recommended Accessories

| Accessory Type | Series | Description | Max Application Voltage | Max Application Amperage |
|----------------|---------------------|--|-------------------------|--------------------------|
| Holder | 245 | Panel Mount Shock-Safe Fuseholder | 300 | 10 |
| | 150 | In-Line Fuseholder | 350 | 10 |
| | 286 | Panel Mount Flip-Top Shock-Safe Fuseholder | 250 | 10 |
| Block | 254 | OMNI-BLOK® Fuse Block | 400 | 10 |
| Clip | 111 | PC Board Mount Fuse Clip | 250 | 10 |

Notes:
1. Do not use in applications above rating.
2. Please refer to fuseholder data sheet for specific re-rating information.
3. Please contact factory for applications greater than the max voltage and amperage shown.

| Packaging | | | | |
|-------------------|-------------------------|----------|---------------------------|------------------|
| Packaging Option | Packaging Specification | Quantity | Quantity & Packaging Code | Taping Width |
| 229 Series | | | | |
| Bulk | N/A | 5 | VX | N/A |
| Bulk | N/A | 5 | VXS | N/A |
| Bulk | N/A | 100 | HX | N/A |
| Bulk | N/A | 100 | HXS | N/A |
| Bulk | N/A | 1000 | MX | N/A |
| Bulk | N/A | 1000 | MXS | N/A |
| 230 Series | | | | |
| Bulk | N/A | 5 | VX | N/A |
| Bulk | N/A | 5 | VXS | N/A |
| Bulk | N/A | 100 | HX | N/A |
| Bulk | N/A | 100 | HXS | N/A |
| Bulk | N/A | 1000 | MX | N/A |
| Bulk | N/A | 1000 | MXE | N/A |
| Bulk | N/A | 1000 | MXF1 | N/A |
| Bulk | N/A | 1000 | MXF16 | N/A |
| Bulk | N/A | 1000 | MXF16O | N/A |
| Bulk | N/A | 1000 | MXF17 | N/A |
| Bulk | N/A | 1000 | MXF17O | N/A |
| Bulk | N/A | 1000 | MXF23 | N/A |
| Bulk | N/A | 1000 | MXF23O | N/A |
| Bulk | N/A | 1000 | MXF32 | N/A |
| Bulk | N/A | 1000 | MXO | N/A |
| Bulk | N/A | 1000 | MXS | N/A |
| Reel and Tape | EIA 296-E | 1500 | DRT2 | T2=63mm (2.500") |
| Reel and Tape | EIA 296-E | 1500 | DRT2S | T2=63mm (2.500") |
| Reel and Tape | EIA 296-E | 1500 | DRT4 | N/A |
| Reel and Tape | EIA 296-E | 2500 | ERT2 | T2=63mm (2.500") |
| Reel and Tape | EIA 296-E | 2500 | ERT2S | T2=63mm (2.500") |
| Reel and Tape | EIA 296-E | 1000 | MRT1E | T1=53mm (2.087") |
| Reel and Tape | EIA 296-E | 1500 | DAT1 | T1=53mm (2.087") |
| Reel and Tape | EIA 296-E | 1500 | DAT1O | T1=53mm (2.087") |
| Reel and Tape | EIA 296-E | 1500 | DRT1 | T1=53mm (2.087") |
| Reel and Tape | EIA 296-E | 1500 | DRT1S | T1=53mm (2.087") |
| Reel and Tape | EIA 296-E | 1500 | DRT1SS | T1=53mm (2.087") |
| Reel and Tape | EIA 296-E | 1500 | DRT3 | T3=73mm (2.874") |
| Reel and Tape | EIA 296-E | 1500 | DRT3S | T3=73mm (2.874") |
| Reel and Tape | EIA 296-E | 2500 | ERT1 | T1=53mm (2.087") |
| Reel and Tape | EIA 296-E | 2500 | ERT1S | T1=53mm (2.087") |
| Reel and Tape | EIA 296-E | 2500 | ERT3 | T3=73mm (2.874") |
| Reel and Tape | EIA 296-E | 2500 | ERT3S | T3=73mm (2.874") |