

阅读申明

- 1.本站收集的数据手册和产品资料都来自互联网，版权归原作者所有。如读者和版权方有任何异议请及时告之，我们将妥善解决。
- 2.本站提供的中文数据手册是英文数据手册的中文翻译，其目的是协助用户阅读，该译文无法自动跟随原稿更新，同时也可能存在翻译上的不当。建议读者以英文原稿为参考以便获得更精准的信息。
- 3.本站提供的产品资料，来自厂商的技术支持或者使用者的心得体会等，其内容可能存在描述上的差异，建议读者做出适当判断。
- 4.如需与我们联系，请发邮件到marketing@iczoom.com，主题请标有“数据手册”字样。

Read Statement

1. The datasheets and other product information on the site are all from network reference or other public materials, and the copyright belongs to the original author and original published source. If readers and copyright owners have any objections, please contact us and we will deal with it in a timely manner.
2. The Chinese datasheets provided on the website is a Chinese translation of the English datasheets. Its purpose is for reader's learning exchange only and do not involve commercial purposes. The translation cannot be automatically updated with the original manuscript, and there may also be improper translations. Readers are advised to use the English manuscript as a reference for more accurate information.
3. All product information provided on the website refer to solutions from manufacturers' technical support or users the contents may have differences in description, and readers are advised to take the original article as the standard.
4. If you have any questions, please contact us at marketing@iczoom.com and mark the subject with "Datasheets" .

382 Series, TR5® Fuse, Time-Lag

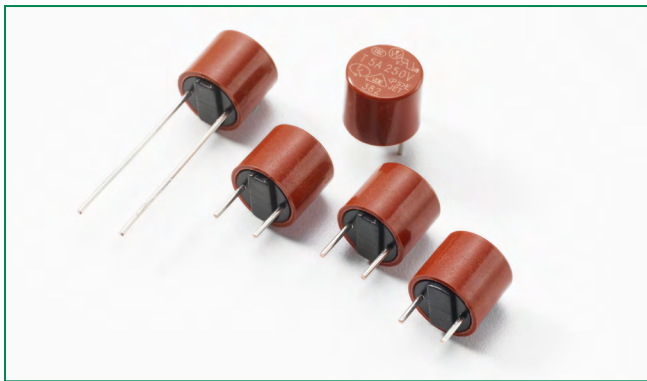

Description

The 382 Series are TE5 Time-Lag type Fuses, 250V rated, with enhanced breaking capacity and designed in accordance to IEC 60127-3.

Features

- Halogen free, Lead-free and RoHS compliant
- Reduced PCB space requirements
- Direct solderable or plug-in versions
- 100A breaking capacity
- Internationally approved
- Low internal resistance
- Shock safe casing
- Vibration resistant
- Available from 1A to 10A

Applications

- Battery Chargers
- Consumer Electronics
- Power supplies
- Industrial Controllers

Agency Approvals

Agency	Agency File Number	Ampere Range
	40018249	1A - 4A
	40018250	5A - 6.3A
	1609346	1A - 6.3A
	E67006	1A - 10A
	JET1896-31007-2001 JET1896-31007-1006	1 - 5A 6.3 - 10A
	2007010207240344	1A - 4A
	CQC07012020713	5A - 6.3A
	SU05024-7003 SU05024-7002 SU05024-7001 SU05024-7004 SU05024-7005	1-2.5A 3.15A 4A 5A 6.3A

Electrical Characteristics

% of Ampere Rating	Opening Time	
	1A - 6.3A	8A - 10A
150%	1 Hour, Min.	1 Hour, Min.
210%	2 Minutes, Max.	300 s, Max.
275%	400 ms, Min. ; 10 Sec., Max.	1 s, Min. ; 20 s, Max.
400%	150 ms, Min. ; 3 Sec., Max.	150 ms, Min. ; 3 Sec., Max.
1000%	20 ms, Min. ; 150 ms, Max.	20 ms, Min. ; 150 ms, Max.

Additional Information



Datasheet









Resources



Samples

Electrical Characteristics

Amp Code	Rated Current	Voltage Rating	Breaking Capacity	Nominal Cold Resistance (Ohms)	Voltage Drop $1.0 \times I_N$ max. (mV)	Power Dissipation $1.5 \times I_N$ max. (mW)	Melting Integral $10 \times I_N$ min. (A ² s)	Agency Approvals					
													
1100	1.00 A	250 V	100A @250VAC	0.0625	100	400	4.85	X	X	X	X	X	X
1125	1.25 A	250 V		0.0500	95	465	6.88	X	X	X	X	X	X
1160	1.60 A	250 V		0.0377	90	490	12.67	X	X	X	X	X	X
1200	2.00 A	250 V		0.0280	85	670	17.80	X	X	X	X	X	X
1250	2.50 A	250 V		0.0215	80	750	29.69	X	X	X	X	X	X
1315	3.15 A	250 V		0.0176	75	900	45.35	X	X	X	X	X	X
1400	4.00 A	250 V		0.0138	70	1200	72.00	X	X	X	X	X	X
1500	5.00 A	250 V		0.0108	65	1250	121.25	X	X	X	X	CQC	X
1630	6.30 A	250 V		0.0076	65	1400	148.84	X	X	X	X	CQC	X
1800	8.00 A	250 V		0.0059	63	1600	233.60			X	X		
2100	10.00 A	250 V		0.0042	57	1600	365.00			X	X		

Notes:

- 1.00 means the number one with two decimal places. 1,000 means the number one thousand.
- Resistance is measured at 10% of rated current, 25°C.

Temperature Re-rating Curve

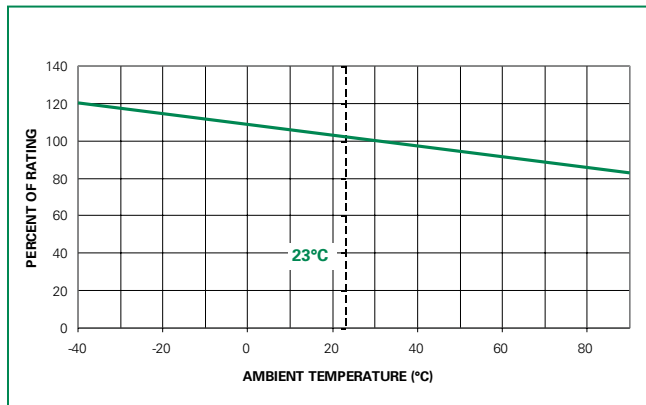

Note:

1. Rerating depicted in this curve is in addition to the standard derating of 25% for continuous operation.

Average Time Current Curves

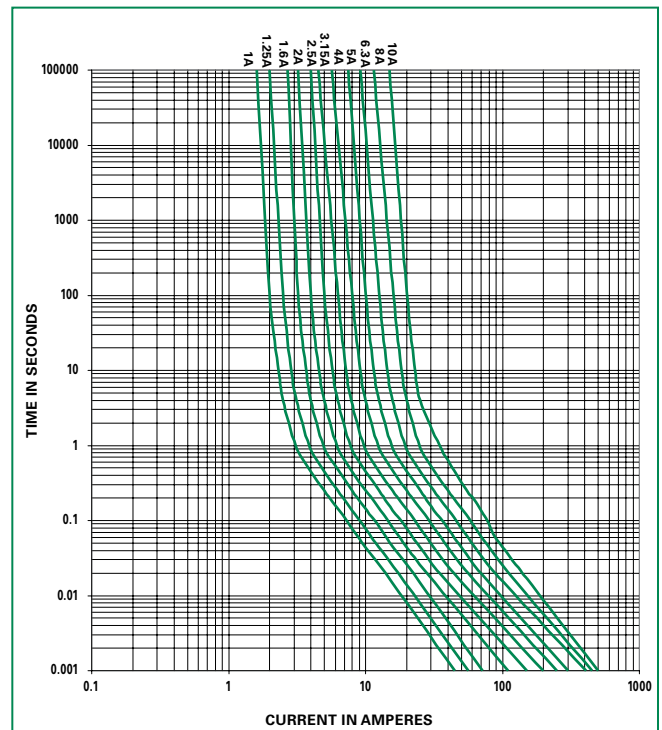

Soldering Parameters - Wave Soldering

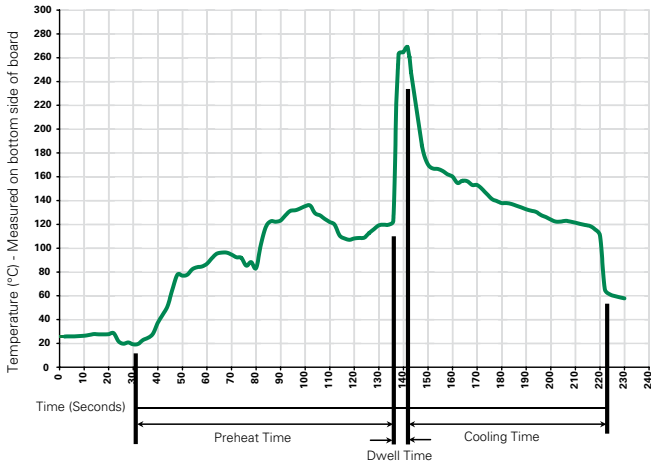

Recommended Process Parameters:

Wave Parameter	Lead-Free Recommendation
Preheat: (Depends on Flux Activation Temperature)	(Typical Industry Recommendation)
Temperature Minimum:	100°C
Temperature Maximum:	150°C
Preheat Time:	60-180 seconds
Solder Pot Temperature:	260°C Maximum
Solder Dwell Time:	2-5 seconds

Recommended Hand-Solder Parameters:

Solder Iron Temperature: 350°C +/- 5°C
Heating Time: 5 seconds max.

Note: These devices are not recommended for IR or Convection Reflow process.

Product Characteristics

Materials	Base/Cap: Brown Thermoplastic Polyamide PA 6.6, UL 94 V-0 Round Pins: Copper, Tin-plated
Lead Pull Strength	10 N (IEC 60068-2-21)
Solderability	260°C, ≤ 3s. (Wave) 350°C, ≤ 1s. (Soldering Iron)
Soldering Heat Resistance	260°C, 10s. (IEC 60068-2-20) 350°C, 3s. (Soldering Iron)

Operating Temperature	-40°C to +85°C (consider re-rating)
Climatic Category	-40°C to +85°C /21 days (IEC 60068-1,-2-1,-2-2,-2-78)
Stock Conditions	+10°C to +60°C RH ≤ 75% yearly average, without dew, maximum value for 30 days-95%
Vibration Resistance	24 cycles at 15 min. each (IEC 60068-2-6) 10 - 60 Hz at 0.75 mm amplitude 60 - 2000 Hz at 10 g acceleration

Dimensions

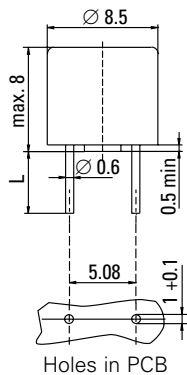

Long Leads (L=18.8mm)
Short Leads (L=4.3mm)

Part Numbering System

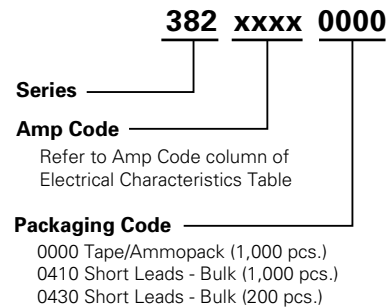

Packaging

Packaging Option	Packaging Specification	Quantity	Quantity & Packaging Code	Taping Width
382 Series				
Tape & Ammopack	N/A	1,000	0000	N/A
Short Leads	N/A	1,000	0410	N/A
Short Leads	N/A	200	0430	N/A