

## 阅读申明

- 1.本站收集的数据手册和产品资料都来自互联网，版权归原作者所有。如读者和版权方有任何异议请及时告之，我们将妥善解决。
- 2.本站提供的中文数据手册是英文数据手册的中文翻译，其目的是协助用户阅读，该译文无法自动跟随原稿更新，同时也可能存在翻译上的不当。建议读者以英文原稿为参考以便获得更精准的信息。
- 3.本站提供的产品资料，来自厂商的技术支持或者使用者的心得体会等，其内容可能存在描述上的差异，建议读者做出适当判断。
- 4.如需与我们联系，请发邮件到marketing@iczoom.com，主题请标有“数据手册”字样。











## Read Statement

1. The datasheets and other product information on the site are all from network reference or other public materials, and the copyright belongs to the original author and original published source. If readers and copyright owners have any objections, please contact us and we will deal with it in a timely manner.
2. The Chinese datasheets provided on the website is a Chinese translation of the English datasheets. Its purpose is for reader's learning exchange only and do not involve commercial purposes. The translation cannot be automatically updated with the original manuscript, and there may also be improper translations. Readers are advised to use the English manuscript as a reference for more accurate information.
3. All product information provided on the website refer to solutions from manufacturers' technical support or users the contents may have differences in description, and readers are advised to take the original article as the standard.
4. If you have any questions, please contact us at marketing@iczoom.com and mark the subject with "Datasheets" .

### 218 Series, 5x20 mm, Time-Lag Fuse



#### Agency Approvals

Agency	Agency File Number	Ampere Range
	Cartridge: NBK090205-E10480A NBK120802-E10480C	1A – 5A 6.3A – 15A
	Leaded: NBK090205-E10480B NBK120802-E10480D	1A – 5A 6.3A – 15A
	2005010207145715	0.032A – 6.3A
	SU05001-3005 SU05001-2008 SU05001-2009	0.032A – 0.040A 0.050A – 0.800A 1A – 10A
	E10480	0.032A – 16A
	29862	0.032A-10A;15A
	1402476	0.032A – 6.3A
	40013496	0.032A – 10A
	40016604	15A*
	KM41462	0.080A – 6.3A
	N/A	0.032A – 16A

\* Approval for Cartridge versions only

#### Description

5x20mm Time-Lag glass body cartridge fuse designed to IEC specification.

#### Features

- Designed to International IEC Standards for use globally
- Meets the IEC 60127-2, Sheet 3 specification for Time-Lag fuses
- Available in cartridge and axial lead form
- RoHS compliant and lead-free

#### Applications

Used as supplementary protection in appliance or utilization equipment to provide individual protection for components or internal circuits.

#### Additional Information



Datasheet



Resources



Samples



Accessories

For recommended fuse accessories for this product series, see '[Recommended Accessories](#)' section.

#### Electrical Characteristics

% of Ampere Rating	Ampere Rating	Opening Time
150%	0.032A-0.100A	60 minutes, Minimum
	0.125A-6.3A	60 minutes, Minimum
	8A-16A	30 minutes, Minimum
210%	0.032A-0.100A	120 sec., Maximum
	0.125A-6.3A	120 sec., Maximum
	8A-16A	120 sec., Maximum
275%	0.032A-0.100A	200 ms., Min.; 10 sec. Max.
	0.125A-6.3A	600 ms., Min.; 10 sec. Max.
	8A-16A	600 ms., Min.; 10 sec. Max.
400%	0.032A-0.100A	40 ms., Min.; 3 sec. Max.
	0.125A-6.3A	150 ms., Min.; 3 sec. Max.
	8A-16A	150 ms., Min.; 3 sec. Max.
1000%	0.032A-0.100A	10 ms., Min.; 300 ms. Max.
	0.125A-6.3A	20 ms., Min.; 300 ms. Max.
	8A-16A	20 ms., Min.; 300 ms. Max.

## Electrical Characteristics

Amp Code	Amp Rating (A)	Voltage Rating (V)	Interrupting Rating	Nominal Cold Resistance (Ohms)	Nominal Melting I <sup>2</sup> t (A <sup>2</sup> sec)	Maximum Voltage Drop at Rated Current (mV)	Maximum Power Dissipation At 1.5In(W)	Agency Approvals									
								UL	CCC	PS E	RU	SF	CS	CE	D'E		
.032	0.032	250	35 A @ 250 VAC	48.2580	0.01100	5000	1.6		x	x		x	x	x	x	x	
.040	0.04	250		31.8620	0.01100	4000	1.6		x	x		x	x	x	x	x	x
.050	0.05	250		21.2920	0.02700	3500	1.6		x	x		x	x	x	x	x	x
.063	0.063	250		14.2680	0.04600	3000	1.6		x	x		x	x	x	x	x	x
.080	0.08	250		9.0700	0.07500	2500	1.6	x	x	x		x	x	x	x	x	x
.100	0.1	250		6.0180	0.07900	2000	1.6	x	x	x		x	x	x	x	x	x
.125	0.125	250		4.2000	0.1465	1900	1.6	x	x	x		x	x	x	x	x	x
.160	0.16	250		3.7000	0.14400	1500	1.6	x	x	x		x	x	x	x	x	x
.200	0.2	250		1.6000	0.3410	1300	1.6	x	x	x		x	x	x	x	x	x
.250	0.25	250		1.0495	0.5405	1100	1.6	x	x	x		x	x	x	x	x	x
.315	0.315	250		0.8475	1.1100	1000	1.6	x	x	x	1.1100	x	x	x	x	x	x
.400	0.4	250		0.5350	1.3250	900	1.6	x	x	x		x	x	x	x	x	x
.500	0.5	250		0.3700	2.8250	300	1.6	x	x	x		x	x	x	x	x	x
.630	0.63	250		0.2750	4.6750	250	1.6	x	x	x		x	x	x	x	x	x
.800	0.8	250		0.0813	3.370	150	1.6	x	x	x		x	x	x	x	x	x
001.	1	250		0.0613	6.730	150	1.6	x	x	x	x	x	x	x	x	x	x
1.25	1.25	250		0.0446	12.650	150	1.6	x	x	x	x	x	x	x	x	x	x
01.6	1.6	250		0.0336	23.350	150	1.6	x	x	x	x	x	x	x	x	x	x
002.	2	250	0.0293	14.450	150	1.6	x	x	x	x	x	x	x	x	x	x	
02.5	2.5	250	0.0219	23.250	120	1.6	x	x	x	x	x	x	x	x	x	x	
3.15	3.15	250	0.0173	38.150	100	1.6	x	x	x	x	x	x	x	x	x	x	
004.	4	250	40 A @ 250 VAC	0.0129	69.10	100	1.6	x	x	x	x	x	x	x	x	x	
005.	5	250	50 A @ 250 VAC	0.0104	111.00	100	1.6	x	x	x	x	x	x	x	x	x	
06.3	6.3	250	63 A @ 250 VAC	0.0076	198.50	100	1.6	x	x	x	x	x	x	x	x	x	
008.	8	250	80 A @ 250 VAC	0.0059	341.50	100	4		x		x	x	x		x	x	
010.	10	250	100 A @ 250 VAC	0.0045	568.00	100	4		x		x	x	x		x	x	
12.5	12.5	250	63 A @ 250 VAC	0.0034	889.00	100	4				x	x			x		
015.	15	250	100 A @ 250 VAC	0.0028	1405.00	100	4				x	x	x		x	x*	
016.	16	250	63 A @ 250 VAC	0.0021	1955.00	100	4				x				x		

\* Approval for cartridge versions only

## Temperature Re-rating Curve

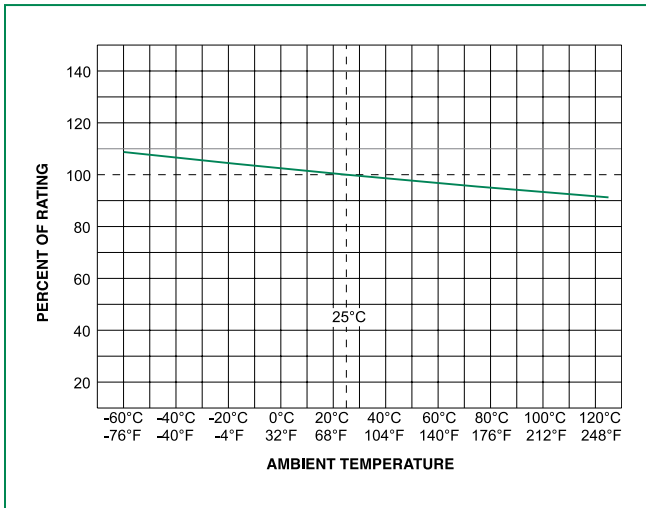

## Average Time Current Curves

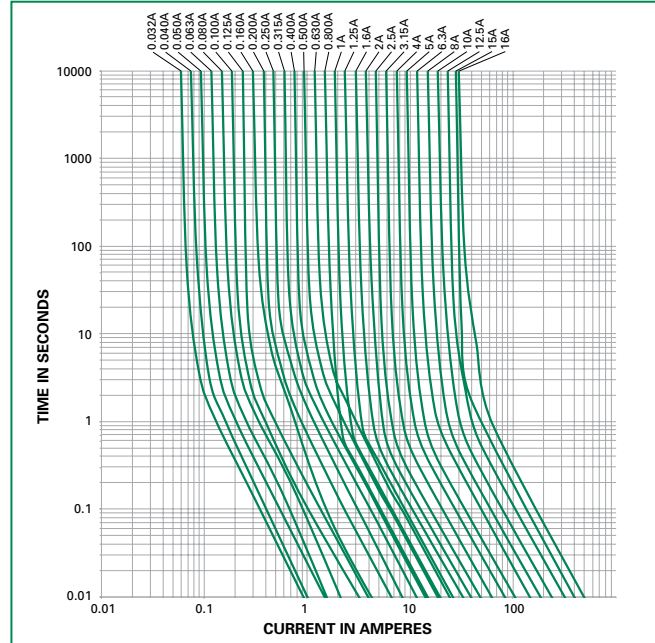

### Soldering Parameters - Wave Soldering

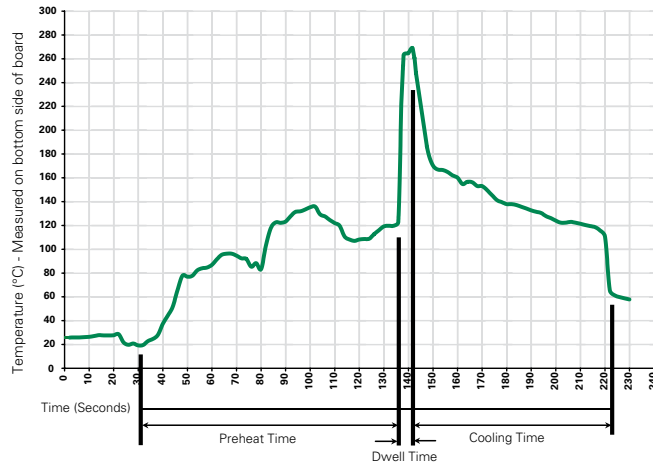

### Recommended Process Parameters:

Wave Parameter	Lead-Free Recommendation
<b>Preheat:</b> (Depends on Flux Activation Temperature)	(Typical Industry Recommendation)
Temperature Minimum:	100°C
Temperature Maximum:	150°C
Preheat Time:	60-180 seconds
<b>Solder Pot Temperature:</b>	260°C Maximum
<b>Solder Dwell Time:</b>	2-5 seconds

### Recommended Hand-Solder Parameters:

Solder Iron Temperature: 350°C +/- 5°C  
 Heating Time: 5 seconds max.

**Note: These devices are not recommended for IR or Convection Reflow process.**

### Product Characteristics

<b>Material</b>	<b>Body:</b> Glass <b>Cap:</b> Nickel-plated Brass <b>Leads:</b> Tin-plated Copper
<b>Terminal Strength</b>	MIL-STD-202, Method 211, Test Condition A
<b>Solderability</b>	MIL-STD-202, Method 208
<b>Product Marking</b>	<b>Cap1:</b> Brand logo, current and voltage ratings <b>Cap2:</b> Agency approval marks
<b>Packaging</b>	Available in Bulk (M=1000 pcs/pkg) or on Tape/Reel (MRET1=1000 pcs/reel)

<b>Operating Temperature</b>	-55°C to +125°C
<b>Thermal Shock</b>	MIL-STD-202, Method 107, Test Condition B (5 cycles, -65°C to +125°C)
<b>Vibration</b>	MIL-STD-202, Method 201
<b>Humidity</b>	MIL-STD-202, Method 103, Test Condition A (High RH (95%) and elevated temperature (40°C) for 240 hours)
<b>Salt Spray</b>	MIL-STD-202, Method 101, Test Condition B

### Dimensions

0218 000P

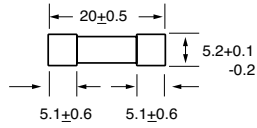

0218.032 XEP  
to  
0218.100XEP

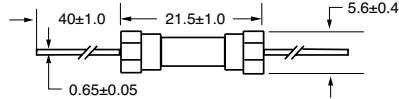

0218.125 XEP  
to  
0218016. XEP

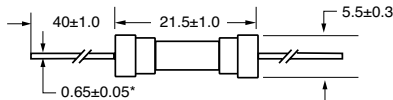

All dimensions in mm

Notes:

\* Ratings above 6.3A have 0.8±0.05 diameter lead.

### Part Numbering System

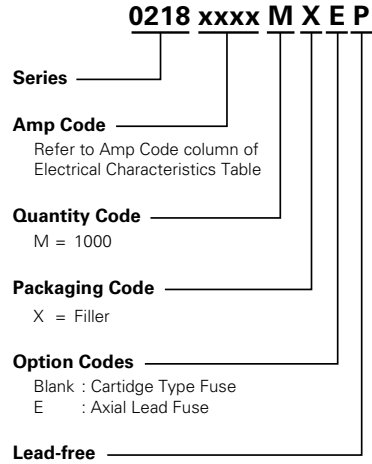

### Packaging

Packaging Option	Packaging Specification	Quantity	Quantity & Packaging Code	Taping Width
<b>218 Series</b>				
Bulk	N/A	1000	MX	N/A
Bulk	N/A	1000	MXE	N/A
Reel and Tape	EIA 296-E	1000	MRET1	T1=53mm (2.087")
Bulk	N/A	1000	MXG	N/A
Bulk	N/A	1000	MXB	N/A
Bulk	N/A	100	HX	N/A

### Recommended Accessories

Accessory Type	Series	Description	Max Application Voltage	Max Application Amperage
Holder	<a href="#">345_ISF</a>	Panel Mount Shock-Safe Fuseholder	250	10
	<a href="#">345</a>	Shock-Safe Fuseholder with PC Mount, Solder Mount and Panel Mount options		20
	<a href="#">830</a>	PC Mount Shock-Safe Miniature Fuseholder		16
Block	<a href="#">520</a>	Metric OMNI-BLOK® Fuse Block		10
	<a href="#">646</a>	PC Mount Miniature Fuse Block		6.3
	<a href="#">658</a>	Surface Mount Miniature Fuse Block		10
Clip	<a href="#">520_W</a>	PC Mount Miniature Fuse Clip		6.3
	<a href="#">111</a>	PC Board Mount Fuse Clip		10
	<a href="#">445</a>	PC Board Mount Fuse Clip		10

Notes:

- Do not use in applications above rating.
- Please refer to fuseholder data sheet for specific re-rating information.
- Please contact factory for applications greater than the max voltage and amperage shown.

**Disclaimer Notice - Information furnished is believed to be accurate and reliable. However, users should independently evaluate the suitability of and test each product selected for their own applications. Littelfuse products are not designed for, and may not be used in, all applications. Read complete Disclaimer Notice at [www.littelfuse.com/disclaimer-electronics](http://www.littelfuse.com/disclaimer-electronics).**