

## 阅读申明

- 1.本站收集的数据手册和产品资料都来自互联网，版权归原作者所有。如读者和版权方有任何异议请及时告之，我们将妥善解决。
- 2.本站提供的中文数据手册是英文数据手册的中文翻译，其目的是协助用户阅读，该译文无法自动跟随原稿更新，同时也可能存在翻译上的不当。建议读者以英文原稿为参考以便获得更精准的信息。
- 3.本站提供的产品资料，来自厂商的技术支持或者使用者的心得体会等，其内容可能存在描述上的差异，建议读者做出适当判断。
- 4.如需与我们联系，请发邮件到marketing@iczoom.com，主题请标有“数据手册”字样。

## Read Statement

1. The datasheets and other product information on the site are all from network reference or other public materials, and the copyright belongs to the original author and original published source. If readers and copyright owners have any objections, please contact us and we will deal with it in a timely manner.
2. The Chinese datasheets provided on the website is a Chinese translation of the English datasheets. Its purpose is for reader's learning exchange only and do not involve commercial purposes. The translation cannot be automatically updated with the original manuscript, and there may also be improper translations. Readers are advised to use the English manuscript as a reference for more accurate information.
3. All product information provided on the website refer to solutions from manufacturers' technical support or users the contents may have differences in description, and readers are advised to take the original article as the standard.
4. If you have any questions, please contact us at marketing@iczoom.com and mark the subject with "Datasheets" .

### 312/318 Series Lead-Free 3AG, Fast-Acting Fuse

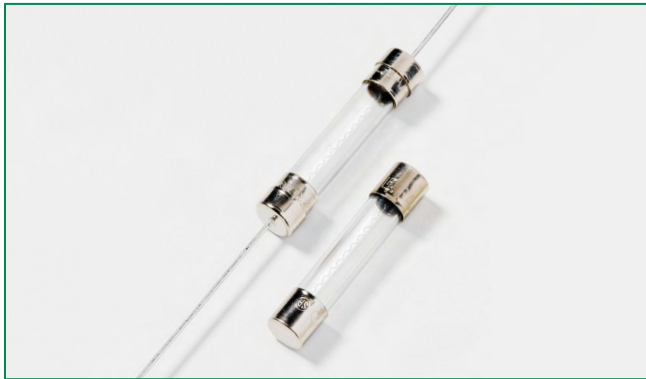

#### Description

The 3AG Fast-Acting Fuse solves a broad range of application requirements while offering reliable performance and cost-effective circuit protection.







#### Features

- In accordance with UL Standard 248-14
- Available in cartridge and axial lead format and with various forming dimensions
- RoHS compliant and Lead-free

#### Applications

Used as supplementary protection in appliance or utilization equipment to provide individual protection for components or internal circuits.

#### Agency Approvals

Agency	Agency File Number	Ampere Range
	E10480	312 Series: 0.062A - 30A 318 Series: 0.062A - 10A
	29862	312 Series: 0.062A - 30A 318 Series: 0.062A - 10A
	NBK040205-E10480B/F NBK040205-E10480D/H	312/318 Series 1A-5A 312/318 Series 6A-10A
	E10480	318 Series: 12A - 30A
	SU05001-6008 SU05001-5005 SU05001-5006	312/318 Series: 1-2A 312/318 Series: 3-6A 312/318 Series: 7-10A
	N/A	312 Series: 0.062A - 10A 318 Series: 0.062A - 10A

#### Electrical Characteristics for Series

% of Ampere Rating	Ampere Rating	Opening Time
100%	0.062A – 35A	4 hours, Minimum
135%	0.062A – 35A	1 hour, Maximum
200%	0.062A – 10A	5 sec., Maximum
	12A – 30A	10 sec., Maximum
	35A	20 sec., Maximum

#### Additional Information



**Datasheet**  
312 Series



**Resources**  
312 Series



**Samples**  
312 Series



**Accessories**  
312 & 318 Series



**Datasheet**  
318 Series



**Resources**  
318 Series



**Samples**  
318 Series

For recommended fuse accessories for this product series, see ['Recommended Accessories'](#) section.

### Electrical Characteristic Specifications by Item

Amp Code	Ampere Rating (A)	Voltage Rating (V)	Interrupting Rating	Nominal Cold Resistance (Ohms)	Nominal Melting I <sup>2</sup> t (A <sup>2</sup> sec)	Agency Approvals						
						UL	cRU <sub>s</sub>	K	PSE	SF	CE	
.062	0.062	250	35A@250Vac 10KA@125Vac	24.7000	0.000249	x				x	x	
.100	0.1	250		11.2800	0.00171	x					x	x
.125	0.125	250		7.1450	0.00289	x					x	x
.150	0.15	250		5.1300	0.00550	x					x	x
.175	0.175	250		3.8750	0.00960	x					x	x
.187	0.187	250		3.4200	0.0128	x					x	x
.200	0.2	250		3.0200	0.0165	x					x	x
.250	0.25	250		2.0100	0.0355	x					x	x
.300	0.3	250		1.4050	0.0689	x					x	x
.375	0.375	250		0.8250	0.185	x					x	x
.500	0.5	250		0.4980	0.483	x					x	x
.600	.6	250		0.3620	0.880	x					x	x
.750	0.75	250		0.2445	1.84	x					x	x
001.	1	250		0.1900	0.760	x			x	x	x	x
1.25	1.25	250		100A@250Vac 10KA@125Vac	0.1385	1.45	x		x	x	x	x
01.5	1.5	250	0.1036		2.35	x			x	x	x	x
01.6	1.6	250	0.0934		2.80	x		x	x	x	x	x
1.75	1.75	250	0.0856		3.60	x			x	x	x	x
01.8	1.8	250	0.0825		3.85	x			x	x	x	x
002.	2	250	0.0704		5.20	x			x	x	x	x
2.25	2.25	250	0.0594		7.20	x			x	x	x	x
02.5	2.5	250	0.0513		9.54	x			x	x	x	x
003.	3	250	0.0427		14.0	x			x	x	x	x
004.	4	250	200A@250Vac 10KA@125Vac		0.0293	28.5	x		x	x	x	x
005.	5	250		0.0224	50.0	x			x	x	x	x
006.	6	250		0.0178	118.0	x			x	x	x	x
007.	7	250		0.0146	81.0	x			x	x	x	x
008.	8	250		0.0122	166.0	x			x	x	x	x
010.	10	250		0.0093	298.0	x			x	x	x	x
012.*	12	32		300A@32 Vac	0.0072	234.6	x	x**			x	
015.*	15	32	0.0052		490.5	x	x**				x	
020.*	20	32	0.0035		1414	x	x**				x	
025.*	25	32	0.0024		2041	x	x**				x	
030.*	30	32	0.0019		3717	x	x**				x	
035.	35	32	0.0013		7531							

NOTES:

\*\* For 318 Series 12A to 30A, the agency approval is only cURus.

**Temperature Re-rating Curve**

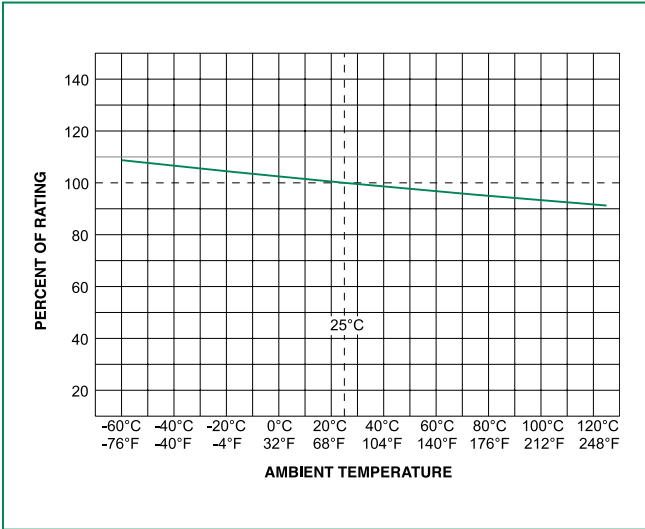

Note:  
Rerating depicted in this curve is in addition to the industry practice derating of 25% for continuous operation.

**Average Time Current Curves**

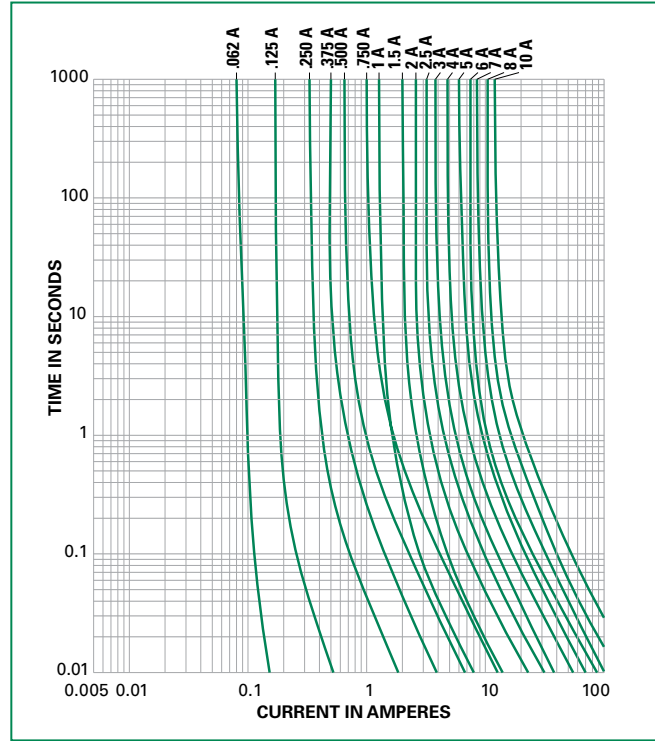

Please contact Littelfuse for more details on those T-C Curves of other ampere ratings which are not published.

**Soldering Parameters - Wave Soldering**

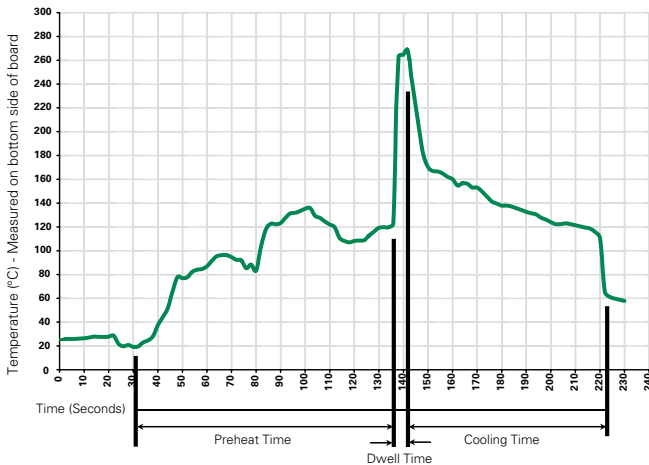

**Recommended Process Parameters:**

Wave Parameter	Lead-Free Recommendation
<b>Preheat:</b> (Depends on Flux Activation Temperature)	(Typical Industry Recommendation)
Temperature Minimum:	100°C
Temperature Maximum:	150°C
Preheat Time:	60-180 seconds
<b>Solder Pot Temperature:</b>	260°C Maximum
<b>Solder Dwell Time:</b>	2-5 seconds

**Recommended Hand-Solder Parameters:**

Solder Iron Temperature: 350°C +/- 5°C  
Heating Time: 5 seconds max.

**Note: These devices are not recommended for IR or Convection Reflow process.**

## Product Characteristics

<b>Materials</b>	Body: Glass Cap: Nickel-plated brass Leads: Tin-plated Copper
<b>Terminal Strength</b>	MIL-STD-202, Method 211, Test Condition A
<b>Solderability</b>	MIL-STD-202 method 208
<b>Product Marking</b>	Cap1: Brand logo, current and voltage ratings Cap2: Series and agency approval marks

<b>Operating Temperature</b>	-55°C to +125°C
<b>Thermal Shock</b>	MIL-STD-202, Method 107, Test Condition B: (5 cycles -65°C to +125°C)
<b>Vibration</b>	MIL-STD-202, Method 201
<b>Humidity</b>	MIL-STD-202, Method 103, Test Condition A: High RH (95%), and Elevated temperature (40°C) for 240 hours
<b>Salt Spray</b>	MIL-STD-202, Method 101, Test Condition B

## Dimensions

Measurements displayed in millimeters (inches)

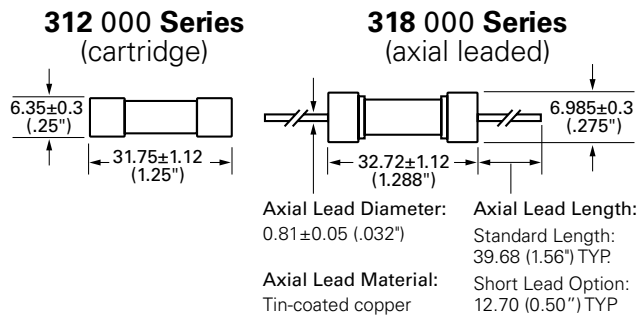

## Part Numbering System

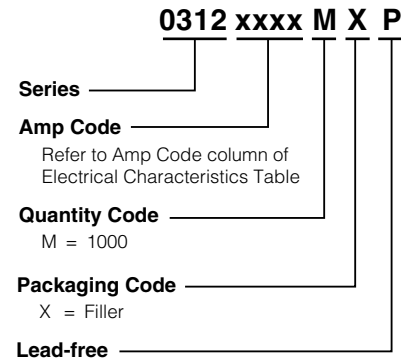

## Packaging

Packaging Option	Packaging Specification	Quantity	Quantity & Packaging Code	Taping Width
<b>312 Series</b>				
Bulk	N/A	1000	MX	N/A
Bulk	N/A	100	HX	N/A
<b>318 Series</b>				
Bulk	N/A	1000	MX	N/A
Bulk	N/A	100	HX	N/A
Bulk	N/A	1000	MXB	N/A

### Recommended Accessories

Accessory Type	Series	Description	Max Application Voltage	Max Application Amperage
Holder	<a href="#">155100</a>	Twist-Lock In-Line Fuseholder	32	20
	<a href="#">342</a>	Traditional Panel Mount Fuseholder	250	20
	<a href="#">346</a>	Panel Mount Flip-Top Shock-Safe Fuseholder	250	15
	<a href="#">345</a>	Shock-Safe Fuseholder with PC Mount, Solder Mount and Panel Mount options	250	20
Block	<a href="#">354</a>	Low Profile OMNI-BLOK® Fuse Block	600	30
	<a href="#">359</a>	High Current Screw Terminal Fuse Block		30
Clip	<a href="#">122</a>	High Current Traditional PC Board Fuse Clip	1000	30
	<a href="#">101</a>	Rivet/Eyelet Type Fuse Clip	1000	15

Notes:

1. Do not use in applications above rating.
2. Please refer to fuseholder data sheet for specific re-rating information.
3. Please contact factory for applications greater than the max voltage and amperage shown.