

## 阅读申明

- 1.本站收集的数据手册和产品资料都来自互联网，版权归原作者所有。如读者和版权方有任何异议请及时告之，我们将妥善解决。
- 2.本站提供的中文数据手册是英文数据手册的中文翻译，其目的是协助用户阅读，该译文无法自动跟随原稿更新，同时也可能存在翻译上的不当。建议读者以英文原稿为参考以便获得更精准的信息。
- 3.本站提供的产品资料，来自厂商的技术支持或者使用者的心得体会等，其内容可能存在描述上的差异，建议读者做出适当判断。
- 4.如需与我们联系，请发邮件到marketing@iczoom.com，主题请标有“数据手册”字样。

## Read Statement

1. The datasheets and other product information on the site are all from network reference or other public materials, and the copyright belongs to the original author and original published source. If readers and copyright owners have any objections, please contact us and we will deal with it in a timely manner.
2. The Chinese datasheets provided on the website is a Chinese translation of the English datasheets. Its purpose is for reader's learning exchange only and do not involve commercial purposes. The translation cannot be automatically updated with the original manuscript, and there may also be improper translations. Readers are advised to use the English manuscript as a reference for more accurate information.
3. All product information provided on the website refer to solutions from manufacturers' technical support or users the contents may have differences in description, and readers are advised to take the original article as the standard.
4. If you have any questions, please contact us at marketing@iczoom.com and mark the subject with "Datasheets" .

# FKS ATO® STYLE BLADE FUSE RATED 80V



## Specifications

Interrupting Rating:	1000 A @ 80 VDC
Insulating Body:	Out of thermoplastic (UL 94-V0, heat-resistant)
Cover:	Out of thermoplastic (UL 94-V0, heat-resistant) Red, not transparent
Terminals:	Blade contacts Copper alloy, gal. Sn plated Edge-protected
Complies with:	UL 248 Special Purpose Fuses
cULus Recognized:	File No. E10480

## Ordering Information

Part Number	Package Size
166.7000.xxx2	500
166.7000.xxx6	100









## Description

The FKS-80 is an ATO® style blade fuse rated at 80V, featuring a three part construction with copper contacts for excellent reliability in harsh environment conditions and low voltage drop. Current ratings 3A thru 30A. Filled with arc-quenching material.

## Time-Current Characteristics

% of Rating	Opening Time Min / Max (s)
110	360,000 s / -
150	0.500 s / 300 s
200	0.150 s / 20 s
350	0.040 s / 0.500 s
600	0.020 s / 0.100 s

## Ratings

Part Number	Current Rating	Housing Color	Typ. Voltage Drop	Cold Resistance	I <sup>2</sup> t
166.7000.430_	3 A		145 mV	39.0 mΩ	8.10 A <sup>2</sup> s
166.7000.440_	4 A		140 mV	29.0 mΩ	14.4 A <sup>2</sup> s
166.7000.450_	5 A		140 mV	20.6 mΩ	24.3 A <sup>2</sup> s
166.7000.475_	7.5 A		120 mV	11.5 mΩ	44.5 A <sup>2</sup> s
166.7000.510_	10 A		110 mV	7.90 mΩ	86.4 A <sup>2</sup> s
166.7000.515_	15 A		110 mV	4.60 mΩ	162 A <sup>2</sup> s
166.7000.520_	20 A		110 mV	3.30 mΩ	475 A <sup>2</sup> s
166.7000.525_	25 A		105 mV	2.27 mΩ	950 A <sup>2</sup> s
166.7000.530_	30 A		100 mV	1.79 mΩ	1,500 A <sup>2</sup> s

Corresponding holder see Section "Fuse Holders."

**FKS ATO® STYLE BLADE FUSE RATED 80V**



**Dimensions**

Dimensions in mm

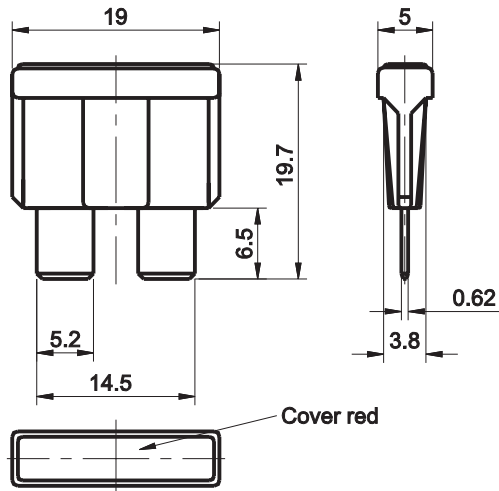

**Pre-Arcing Time-Limits**

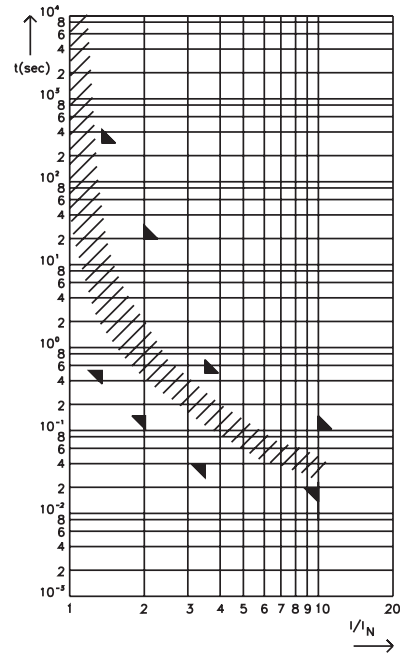

FI = 1.43 (max. operating current:  $0.7 \times I_{rat}$  at 23°C)