

## 阅读申明

- 1.本站收集的数据手册和产品资料都来自互联网，版权归原作者所有。如读者和版权方有任何异议请及时告之，我们将妥善解决。
- 2.本站提供的中文数据手册是英文数据手册的中文翻译，其目的是协助用户阅读，该译文无法自动跟随原稿更新，同时也可能存在翻译上的不当。建议读者以英文原稿为参考以便获得更精准的信息。
- 3.本站提供的产品资料，来自厂商的技术支持或者使用者的心得体会等，其内容可能存在描述上的差异，建议读者做出适当判断。
- 4.如需与我们联系，请发邮件到marketing@iczoom.com，主题请标有“数据手册”字样。

## Read Statement

1. The datasheets and other product information on the site are all from network reference or other public materials, and the copyright belongs to the original author and original published source. If readers and copyright owners have any objections, please contact us and we will deal with it in a timely manner.
2. The Chinese datasheets provided on the website is a Chinese translation of the English datasheets. Its purpose is for reader's learning exchange only and do not involve commercial purposes. The translation cannot be automatically updated with the original manuscript, and there may also be improper translations. Readers are advised to use the English manuscript as a reference for more accurate information.
3. All product information provided on the website refer to solutions from manufacturers' technical support or users the contents may have differences in description, and readers are advised to take the original article as the standard.
4. If you have any questions, please contact us at marketing@iczoom.com and mark the subject with "Datasheets" .

**CG/CG2 Series**

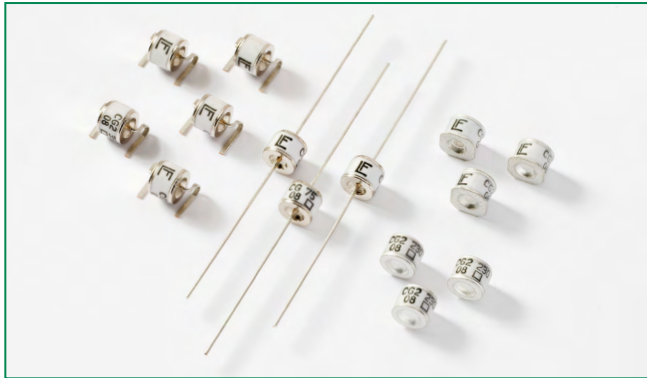

**Description**

Littelfuse highly reliable CG/CG2 Series GDTs provide a high degree of surge protection in a small size ideal for board level circuit protection.

GDTs function as switches which dissipate a minimum amount of energy and therefore handle currents that far surpass other types of transient voltage protection. Their gas-filled, rugged ceramic metal construction make them well suited to adverse environments.

The CG/CG2 series comes in a variety of forms including surface mount, core, straight and shaped leads, to serve a variety of mounting methods.

The CG Series (75V-110V) is ideal for protection of test and communication equipment and other devices in which low voltage limits and extremely low arc voltages are required.

The CG2 Series (145V-1000V) is ideal for protecting equipment where higher voltage limits and holdover voltages are necessary.

**Agency Approvals**

AGENCY	AGENCY FILE NUMBER
	E128662 <sup>1</sup>
	E320116 <sup>2</sup>

NOTES:  
1. Certified to UL 497B.  
2. Only CG2300, CG2470, CG2600, CG2800 and CG221000. Certified to UL 1449.

**2 Electrode GDT Graphical Symbol**



**Additional Information**



**Datasheet**  
CG/CG2



**Resources**  
CG/CG2



**Samples**  
CG/CG2

**Features**

- RoHS and Lead-free compliant
- Rugged Ceramic-Metal construction
- Low Capacitance (<1.5pf)
- Meets REA PE-80
- Available in surface mount, and a variety of lead options options

**Applications**

- Communication lines and equipment
- CATV equipment
- Test equipment
- Data lines
- Power supplies
- Instrumentation circuits
- Medical electronics
- ADSL equipment
- Telecom SLIC protection

### Electrical Characteristics

Part Number	Device Specifications (at 25°C)						Life Ratings								
	DC Breakdown in Volts (@100V/s)			Impulse Break-down in Volts (@100V/μs)	Impulse Break-down In Volts (@1 Kv/μsec)	Insulation Resistance	Capacitance (@1MHz)	Arc Voltage (on state Voltage) @1Amp Min	Surge Life (@500A 10/1000μs)	Nominal Impulse Discharge Current (8/20μs)	Nominal AC Discharge Current (10x1sec @50-60Hz)	AC Discharge Current (9 cycle @50Hz)	DC Holdover Voltage <sup>2</sup>	Max Impulse Discharge Current (1 Application @ 10/350μs)	
	MIN	TYP	MAX	MAX		MIN	MAX	TYP					TYP		
CG75	60	75	90	400	650	10 <sup>10</sup> Ω (at 50V)	1.5 pf	15 V	400 shots	10 shots (@20kA) <sup>3</sup>	20 A	100 A	52 V	4kA	
CG90	72	90	108	400	600										
CG90 SN	72	90	108	400	600										
CG110	88	110	132	450	600	10 <sup>10</sup> Ω (at 100V)							80 V		2.5kA
CG2145	116	145	174	500	600										
CG2145 SN	120	145	174	500	600										
CG2230 <sup>1</sup>	195	230	265	600	700										
CG2230 SN <sup>1</sup>	184	230	276	600	700										
CG2250	213	250	288	625	725										
CG2250 SN	200	250	300	625	725										
CG2300	255	300	345	700	800										
CG2300 SN	240	300	360	700	800										
CG2350	297	350	403	750	900										
CG2350 SN	280	350	420	750	900										
CG2420	357	420	483	800	1000										
CG2470 <sup>1</sup>	400	470	540	850	1200										
CG2470 SN <sup>1</sup>	376	470	564	850	1200										
CG2600 <sup>1</sup>	510	600	690	1000	1400										
CG2600 SN <sup>1</sup>	480	600	720	1000	1400										
CG2800 <sup>1</sup>	680	800	920	1200	1500										
CG21000 <sup>1</sup>	850	1000	1150	1500	1600				10 shots (@10kA)	10 A	65 A				

NOTES:

- Certified to UL 1449.
- Reference REA PE-80, 0.2A. Tested to ITU-T Rec K.12 and REA PE 80 < 150 mSec.
- 5 x [5 (+) or 5 (-)] applications 20kA 8/20μSec. (75 to 600 volt devices.)  
 10 x [5 (+) and 5 (-)] applications 10kA 8/20μSec. (800 and 100 volt devices.)

### Product Characteristics

<b>Materials</b>	<b>LS, Axial:</b> Device: Tin Plated 2–5 Microns Lead Wires: Tin Plated 17.5 ± 12.5 Microns Construction: Ceramic Insulator <b>Core:</b> Device: Tin Plated 17.5 ± 12.5 Microns. Construction: Ceramic Insulator <b>MS:</b> Device: Dull Tin Plated 7–9 Microns Construction: Ceramic Insulator	<b>Glow to arc transition current</b> < 0.5Amps <b>Glow Voltage</b> 60-160 Volts <b>Storage and Operational Temperature</b> -40 to +90 <b>Maximum Follow On Current<sup>1</sup></b> 230 Volts r.m.s, 200 Amps. (800V and 1000V devices tested to UL1449 3rd edition)
	<b>Product Marking</b> LF Logo, Voltage and date code; Black in positive print	

**Device Dimensions**

**Leaded 'L' Type Straight Axial Devices**

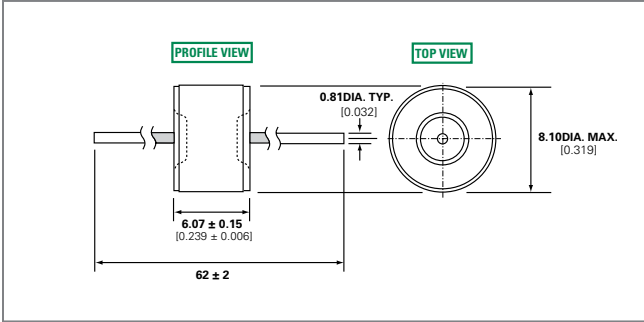

**Leaded 'LS' Type Shaped Lead Devices**

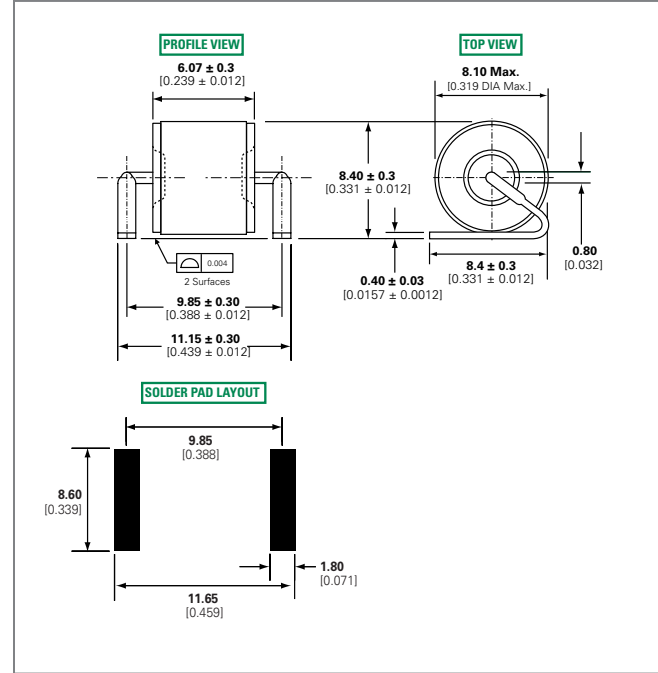

**Core Devices**

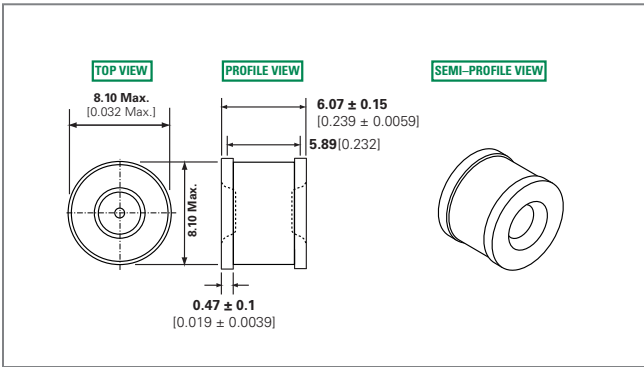

**'MS' Type Devices**

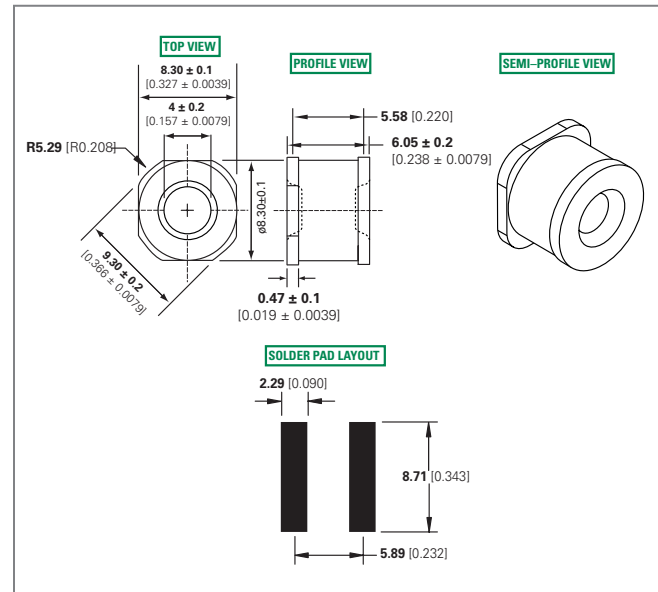

### Soldering Parameters - Reflow Soldering (Surface Mount Devices)

Reflow Condition		Pb – Free assembly
Pre Heat	- Temperature Min ( $T_{s(min)}$ )	150°C
	- Temperature Max ( $T_{s(max)}$ )	200°C
	- Time (Min to Max) ( $t_s$ )	60 – 180 secs
Average ramp up rate (Liquidus Temp ( $T_L$ ) to peak)		3°C/second max
$T_{s(max)}$ to $T_L$ - Ramp-up Rate		5°C/second max
Reflow	- Temperature ( $T_L$ ) (Liquidus)	217°C
	- Temperature ( $t_L$ )	60 – 150 seconds
Peak Temperature ( $T_p$ )		260 <sup>+0/-5</sup> °C
Time within 5°C of actual peak Temperature ( $t_p$ )		10 – 30 seconds
Ramp-down Rate		6°C/second max
Time 25°C to peak Temperature ( $T_p$ )		8 minutes Max.
Do not exceed		260°C

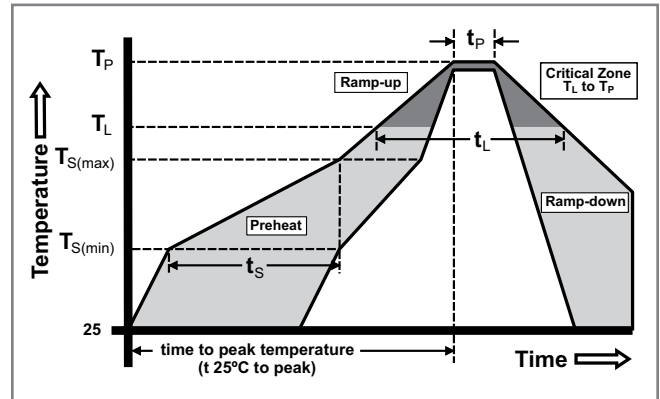

### Soldering Parameters - Wave Soldering (Thru-Hole Devices)

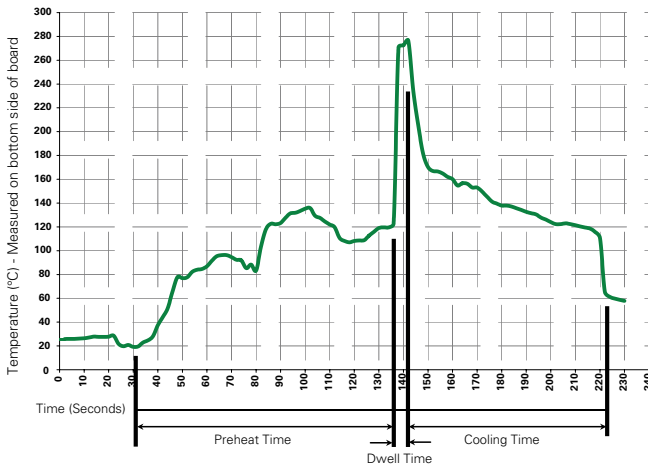

### Recommended Process Parameters:

Wave Parameter	Lead-Free Recommendation
<b>Preheat:</b> (Depends on Flux Activation Temperature) (Typical Industry Recommendation)	
Temperature Minimum:	100° C
Temperature Maximum:	150° C
Preheat Time:	60-180 seconds
<b>Solder Pot Temperature:</b>	280° C Maximum
<b>Solder Dwell Time:</b>	2-5 seconds

### Soldering Parameters - Hand Soldering

Solder Iron Temperature: 350° C +/- 5°C  
 Heating Time: 5 seconds max.

**Packaging Dimensions**

**For 'L' Type Axial Lead Items**

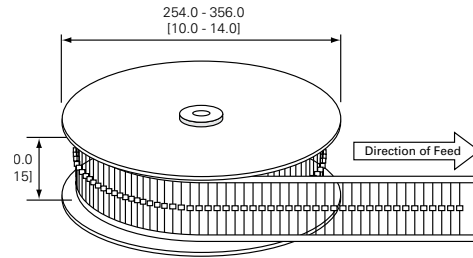
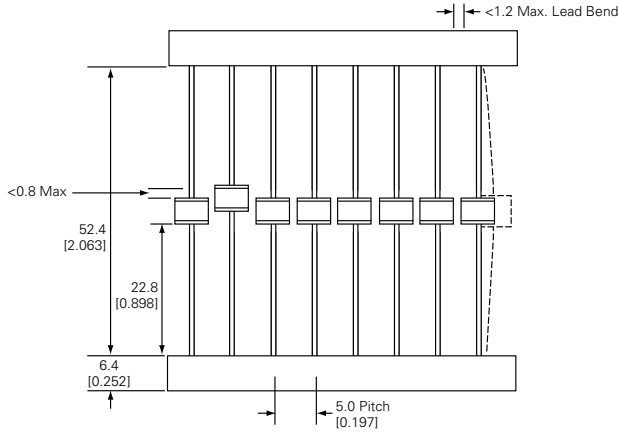

**Core and 'MS' Type Items**

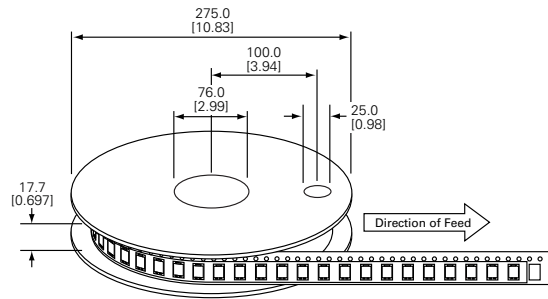
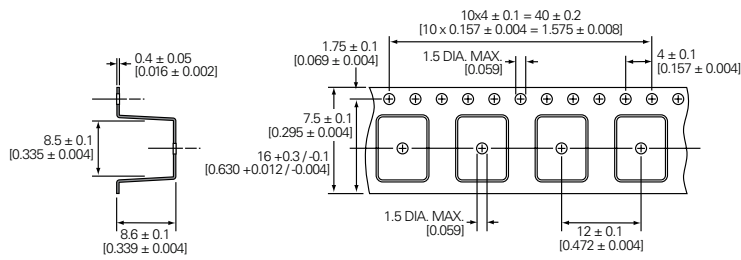

**For 'LS' Type Shaped Lead Items**

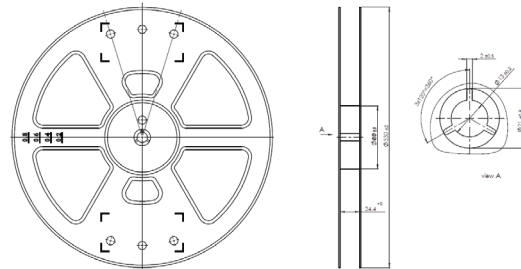
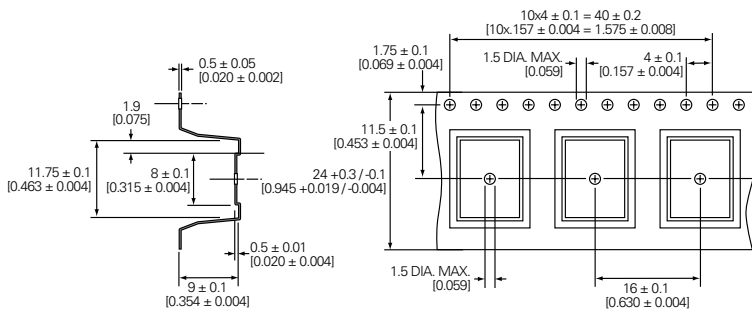

### Part Numbering System and Ordering Information

	<b>CG2</b>	<b>XXX</b>	<b>XX</b>	<b>*</b>	<b>XX</b>
<b>Series</b>					
CG	– for 75, 90, or 110V				
CG2	– for 145V to 1000V				
<b>Breakdown Voltage</b>					
75	300				
90	350				
110	470				
145	600				
230	800				
250	1000				
<b>Lead Option Code</b>					
(Blank)	= No Leads / Core				
L	= Straight Leads				
LS	= Shaped Leads				
MS	= Surface Mount				
<b>Option Code*</b>					
SN	= may have different DC Breakover Voltage Limit. Please refer to Electrical Characteristics table for additional information.				
<b>Packaging Option Code</b>					
(Blank)	= No Leads / Core, Bulk Bag - 400 pcs				
L(Blank)	= Straight Lead, Tray - 50 pcs				
LTR	= Straight Lead, Tape & Reel per EIA RS-296-E - 500 per reel				
LS(Blank)	= Shaped Lead (see LS dimensions), Tape & Reel - 500 per reel				

**Examples:**

**CG75** – A non-leaded 75V device

**CG2230L** – A leaded 230V device

**CG2800LTR** – A leaded 800V device, tape-and-reel (per EIA standard RS-296-D)

**Notes:**

CG/CG2 devices with other breakdown voltages in the 75-1000 V range are available upon request.