

## 阅读申明

- 1.本站收集的数据手册和产品资料都来自互联网，版权归原作者所有。如读者和版权方有任何异议请及时告之，我们将妥善解决。
- 2.本站提供的中文数据手册是英文数据手册的中文翻译，其目的是协助用户阅读，该译文无法自动跟随原稿更新，同时也可能存在翻译上的不当。建议读者以英文原稿为参考以便获得更精准的信息。
- 3.本站提供的产品资料，来自厂商的技术支持或者使用者的心得体会等，其内容可能存在描述上的差异，建议读者做出适当判断。
- 4.如需与我们联系，请发邮件到marketing@iczoom.com，主题请标有“数据手册”字样。

## Read Statement

1. The datasheets and other product information on the site are all from network reference or other public materials, and the copyright belongs to the original author and original published source. If readers and copyright owners have any objections, please contact us and we will deal with it in a timely manner.
2. The Chinese datasheets provided on the website is a Chinese translation of the English datasheets. Its purpose is for reader's learning exchange only and do not involve commercial purposes. The translation cannot be automatically updated with the original manuscript, and there may also be improper translations. Readers are advised to use the English manuscript as a reference for more accurate information.
3. All product information provided on the website refer to solutions from manufacturers' technical support or users the contents may have differences in description, and readers are advised to take the original article as the standard.
4. If you have any questions, please contact us at marketing@iczoom.com and mark the subject with "Datasheets" .



## Features

- Superior circuit protection
- Overcurrent & overvoltage protection
- Blocks surges up to rated limits
- High-speed performance
- Small SMT package
- RoHS compliant\*
- Agency recognition:

## Applications

- SLIC protection
- Cable & DSL
- MDU/MTU modems
- ONT
- Voice/DSL line cards

# TBU-PL Series - TBU® High-Speed Protectors

## General Information

The TBU-PL Series of Bourns® TBU® products are low capacitance dual bidirectional high-speed protection components, constructed using MOSFET semiconductor technology, and designed to protect against faults caused by short circuits, AC power cross, induction and lightning surges.

In addition to overcurrent protection, an added feature is the voltage monitoring on the two lines. If the voltage on the line drops below  $V_{SS}$  then the voltage will trigger the device to switch to the blocking state.

The TBU® high-speed protector placed in the system circuit will monitor the current with the MOSFET detection circuit triggering to provide an effective barrier behind which sensitive electronics will not be exposed to large voltages or currents during surge events. The TBU® device is provided in a surface mount DFN package and meets industry standard requirements such as RoHS and Pb Free solder reflow profiles.

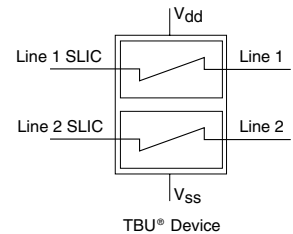

## Agency Approval

Description	
UL	File Number: E315805

## Industry Standards (in Conjunction with OVP Device)

Solutions available for GR-1089-CORE, ITU-T and a combination of both.

## Absolute Maximum Ratings (@ $T_A = 25^\circ\text{C}$ Unless Otherwise Noted)

Symbol	Parameter	Part Number	Value	Unit
$V_{imp}$	Peak impulse voltage withstand with duration less than 10 ms	TBU-PL050-xxx-WH	500	V
		TBU-PL060-xxx-WH	600	
		TBU-PL075-xxx-WH	750	
		TBU-PL085-xxx-WH	850	
$V_{rms}$	Continuous A.C. RMS voltage	TBU-PL050-xxx-WH	300	V
		TBU-PL060-xxx-WH	350	
		TBU-PL075-xxx-WH	400	
		TBU-PL085-xxx-WH	425	
$T_{op}$	Operating temperature range		-55 to +125	$^\circ\text{C}$
$T_{stg}$	Storage temperature range		-65 to +150	$^\circ\text{C}$
$T_{jmax}$	Maximum Junction Temperature		+125	$^\circ\text{C}$
ESD	HBM ESD Protection per IEC 61000-4-2 on line pads		$\pm 2$	kV

## Electrical Characteristics (@ $T_A = 25^\circ\text{C}$ Unless Otherwise Noted)

Symbol	Parameter	Part Number	Min.	Typ.	Max.	Unit	
$I_{trigger}$	Current required for the device to go from operating state to protected state	TBU-PLxxx-100-WH	100	150	200	mA	
		TBU-PLxxx-200-WH	200	300	400		
$R_{device}$	Series resistance of the TBU® device		40	50	55	$\Omega$	
$R_{match}$	Package resistance matching of the TBU® device #1 - TBU® device #2			$\pm 0.5$	$\pm 1.0$	$\Omega$	
$t_{block}$	Time taken for the device to go into current limiting				1	$\mu\text{s}$	
$I_Q$	Current through the triggered TBU® device with 50 Vdc circuit voltage		0.25	0.70	1.50	mA	
$I_{ss}$	Operating current with $V_{SS} = -50\text{ V}$			100		$\mu\text{A}$	
$V_{reset}$	Voltage below which the triggered TBU® device will transition to normal operating state	TBU-PLxxx-100-WH	Forward Mode	12	15	22	V
			Reverse Mode	10	13	20	
		TBU-PLxxx-200-WH	Forward Mode	15	20	25	
			Reverse Mode	12	17	22	
$V_{to}$	Voltage threshold offset with 60 Hz applied voltage, with $V_{SS} = -50\text{ V}$ ( $V_{SS} - V_{lineSLIC}$ )		-1.0		0.2	V	
$V_{SS}$	Operating voltage range relative to $V_{dd}$		-180		-20	V	
$R_{th(j-l)}$	One side junction to package pads - FR4 using minimum recommended pad layout			110		$^\circ\text{C/W}$	
$R_{th(j-l)}$	Both sides junction to package pads - FR4 using minimum recommended pad layout			65		$^\circ\text{C/W}$	
$R_{th(j-l)}$	One side junction to package pads - FR4 using heat sink on board (6 cm <sup>2</sup> ) (0.5 in. <sup>2</sup> )			70		$^\circ\text{C/W}$	
$R_{th(j-l)}$	Both sides junction to package pads - FR4 using heat sink on board (6 cm <sup>2</sup> ) (0.5 in. <sup>2</sup> )			40		$^\circ\text{C/W}$	

\*RoHS Directive 2002/95/EC Jan. 27, 2003 including annex and RoHS Recast 2011/65/EU June 8, 2011. Specifications are subject to change without notice.

The device characteristics and parameters in this data sheet can and do vary in different applications and actual device performance may vary over time. Users should verify actual device performance in their specific applications.

## Functional Block Diagram

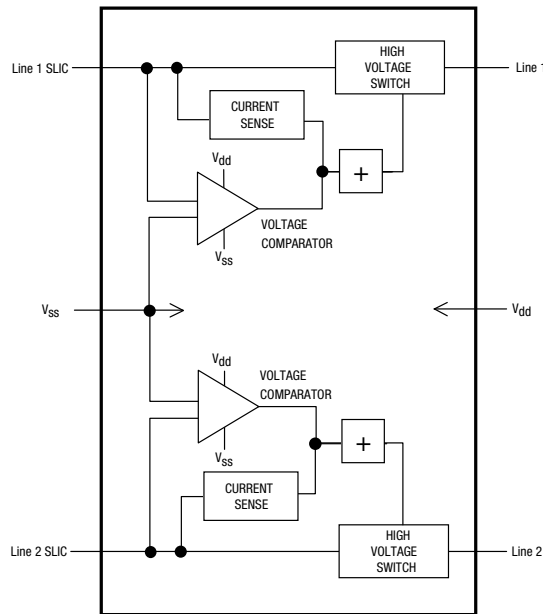

## Reference Application

The TBU-PL Series are high-speed protectors used in voice/VoIP SLIC applications. The maximum voltage rating of the TBU® device should never be exceeded. Where necessary, an OVP device should be employed to limit the maximum voltage. A cost-effective protection solution combines Bourns® TBU® protection devices with a pair of Bourns® MOVs. For bandwidth sensitive applications, a Bourns® GDT may be substituted for the MOV. If EN55024 EMC compliance is required, the TBU® device may require capacitors to be fitted between the Tip and Ring connections and ground.

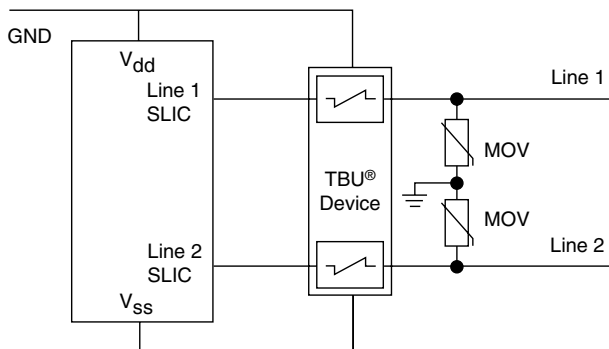

## Basic TBU Operation

The TBU® device, constructed using MOSFET semiconductor technology, placed in the system circuit will monitor the current with the MOSFET detection circuit triggering to provide an effective barrier behind which sensitive electronics are not exposed to large voltages or currents during surge events. The TBU® device operates in approximately  $1 \mu\text{s}$  - once line current exceeds the TBU® device's trigger current  $I_{\text{trigger}}$ . When operated, the TBU® device will limit the current to less than the  $I_{\text{trigger}}$  value within the  $t_{\text{block}}$  duration. If voltage above  $V_{\text{reset}}$  is continuously sustained, the TBU® device will subsequently reduce the current to a quiescent current level within a period of time that is dependent upon the applied voltage.

When the voltage on the SLIC output is driven below  $(V_{\text{bat}} - V_{\text{to}})$  the TBU-PL series device switches to the blocking state, regardless of output current in the device.

After the surge, the TBU® device resets when the voltage across the TBU® device falls to the  $V_{\text{reset}}$  level. The TBU® device will automatically reset on lines which have no DC bias or have DC bias below  $V_{\text{reset}}$  (such as unpowered signal lines).

If the line has a normal DC bias above  $V_{\text{reset}}$ , the voltage across the TBU® device may not fall below  $V_{\text{reset}}$  after the surge. In such cases, special care needs to be taken to ensure that the TBU® device will reset, with software monitoring as one method used to accomplish this. Bourns application engineers can provide further assistance.

# TBU-PL Series - TBU® High-Speed Protectors

# BOURNS®

## Bourns® TBU® Device Solutions

Industry Standard	Surge & AC Withstand	TBU® Device P/N	Qty.	OVP Device P/N	Qty.
Telcordia GR-1089-CORE Intra-building Port Type 4	1500 V, 100 A 2/10 $\mu$ s 120 V <sub>rms</sub> , 25 A, 900 s	TBU-PL050-200-WH	1	MOV-07D201K	2
Telcordia GR-1089-CORE Intra-building Port Type 4a	1000 V, 100 A 10/1000 $\mu$ s 120 V <sub>rms</sub> , 25 A, 900 s	TBU-PL060-200-WH	1	MOV-10D201K	2
Non-GR-1089-CORE Intra-building Specifications	5000 V, 500 A 2/10 $\mu$ s 230 V <sub>rms</sub> , 25 A, 900 s	TBU-PL085-200-WH	1	MOV-10D361K	2
	1500 V, 100 A 2/10 $\mu$ s 275 V <sub>rms</sub> , 25 A, 900 s	TBU-PL085-200-WH	1	MOV-10D431K	2
ITU-T Basic K.20, K.21, K.45	4000 V, 40 $\Omega$ 10/700 $\mu$ s 230 V <sub>rms</sub> 10 $\Omega$ - 1000 $\Omega$ , 900 s 600 V <sub>rms</sub> 600 $\Omega$ , 0.2 s	TBU-PL075-200-WH	1	MOV-10D361K	2
	4000 V, 40 $\Omega$ 10/700 $\mu$ s 230 V rms 10 $\Omega$ - 1000 $\Omega$ , 900 s 600 V rms 600 $\Omega$ , 0.1 s	TBU-PL060-200-WH	1	TISP4400M3BJ	2
ITU-T Enhanced K.20, K.21, K.45	6000 V, 40 $\Omega$ 10/700 $\mu$ s 240 V <sub>rms</sub> 10 $\Omega$ - 1000 $\Omega$ , 900 s 600 V <sub>rms</sub> 600 $\Omega$ , 0.2 s 600 V <sub>rms</sub> 600 $\Omega$ , 1 s* 1500 V <sub>rms</sub> , 200 $\Omega$ , 2 s*	TBU-PL085-200-WH	1	MOV-10D391K	2
	6000 V, 40 $\Omega$ 10/700 $\mu$ s 240 V <sub>rms</sub> 10 $\Omega$ - 1000 $\Omega$ , 900 s 600 V <sub>rms</sub> 600 $\Omega$ , 1 s 1500 V <sub>rms</sub> , 200 $\Omega$ , 2 s	TBU-PL060-200-WH	1	TISP4500H3BJ	2

\* GDT Special Test Protector with DC breakdown (DCBD) of less than 330 V.

### Notes:

- 1) The MOV maximum continuous rms voltage rating should not be exceeded. The exception is where the data sheet highlights withstand capability such as the 600 V<sub>rms</sub>, 1 A for 0.2 s, for example.
- 2) If EN55024 EMC compliance is required, the TBU® device may require capacitors to be fitted between the Tip and Ring connections and ground (i.e. in parallel with the MOV device). The capacitance value can be chosen to meet levels as follows:
  - 10 nF for EN55024 Level 1
  - 20 nF for EN55024 Level 2
  - 47 nF for EN55024 Level 3

Selection of capacitor voltage rating depends upon TBU® part number selection. Recommendations include:

- TBU-PL050 & TBU-PL060 Series: 120 VAC, 500 V Peak Surge Rated
- TBU-PL075 & TBU-PL085 Series: 240 VAC, 750 V Peak Surge Rated

Depending upon the SLIC type, it is usually possible to remove any EMI capacitors present between the output of the SLIC and ground when using capacitors C1 and C2 in parallel with the MOVs.

Specifications are subject to change without notice.

The device characteristics and parameters in this data sheet can and do vary in different applications and actual device performance may vary over time. Users should verify actual device performance in their specific applications.

# TBU-PL Series - TBU® High-Speed Protectors

**BOURNS®**

## Performance Graphs

### Typical V-I Characteristics (TBU-PL085-200-WH)

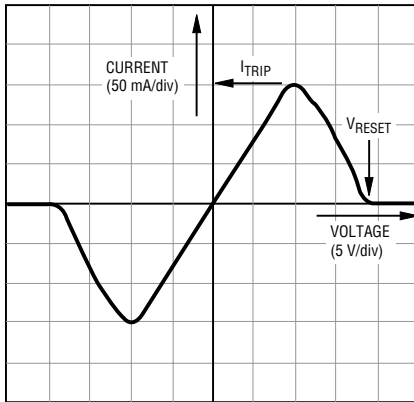

### Typical Trigger Current vs. Temperature

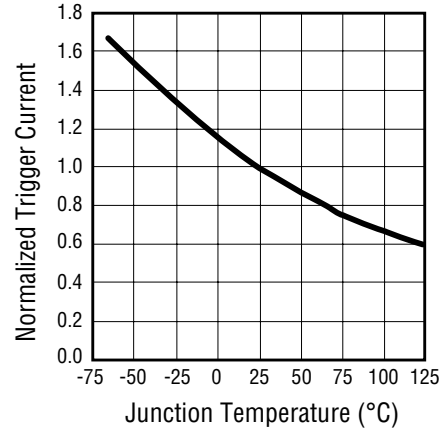

### Tracking Voltage Characteristics

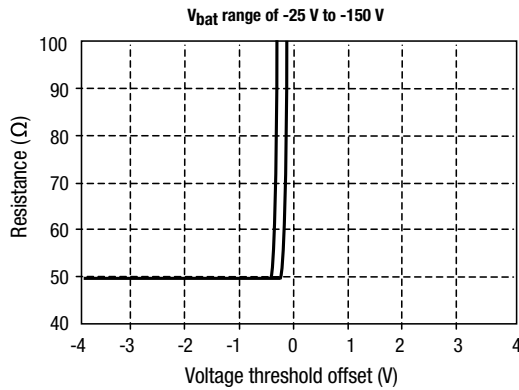

### Typical Resistance vs. Temperature

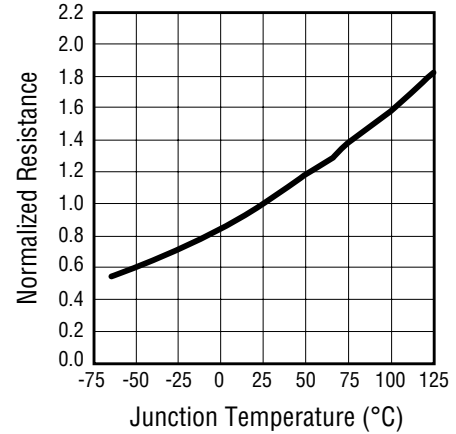

### Power Derating Curve

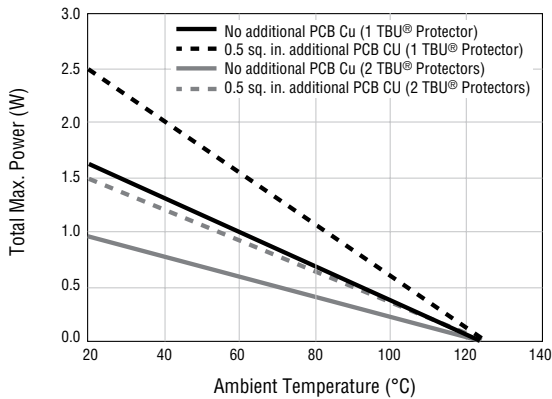

### Typical Surge Response

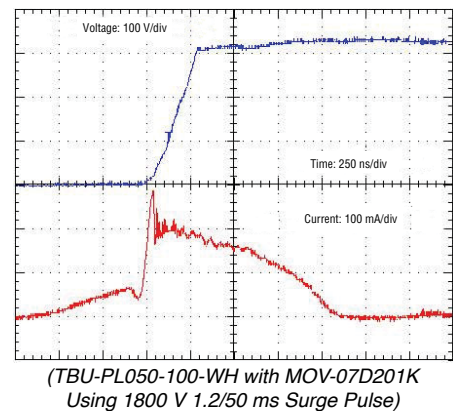

Specifications are subject to change without notice. The device characteristics and parameters in this data sheet can and do vary in different applications and actual device performance may vary over time. Users should verify actual device performance in their specific applications.

# TBU-PL Series - TBU® High-Speed Protectors

**BOURNS®**

## Product Dimensions

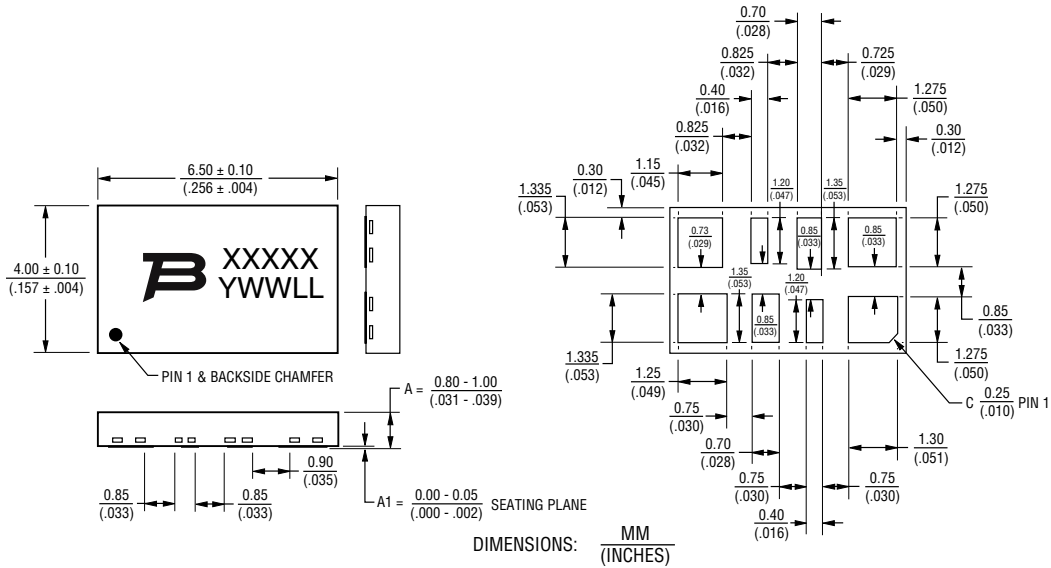

## Recommended Pad Layout

TBU® High-Speed Protectors have a 100 % matte-tin termination finish. For improved thermal dissipation, the recommended layout uses PCB copper areas which extend beyond the exposed solder pad. The exposed solder pads should be defined by a solder mask which matches the pad layout of the TBU® device in size and spacing. It is recommended that they should be the same dimension as the TBU® pads but if smaller solder pads are used, they should be centered on the TBU® package terminal pads and not more than 0.10-0.12 mm (0.004-0.005 in.) smaller in overall width or length. Solder pad areas should not be larger than the TBU® pad sizes to ensure adequate clearance is maintained. The recommended

stencil thickness is 0.10-0.12 mm (0.004-0.005 in.) with a stencil opening size 0.025 mm (0.0010 in.) less than the solder pad size. Extended copper areas beyond the solder pad significantly improve the junction to ambient thermal resistance, resulting in operation at lower junction temperatures with a corresponding benefit of reliability. All pads should be soldered to the PCB, including pads marked as NC or NU but no electrical connection should be made to these pads. For minimum parasitic capacitance, it is recommended that signal, ground or power signals are not routed beneath any pad.

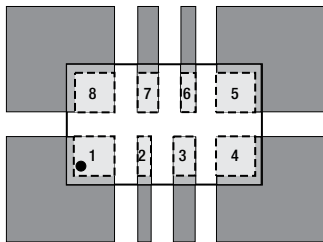

Dark grey areas show added PCB copper area for better thermal resistance.

## Thermal Resistance vs Additional PCB Cu Area

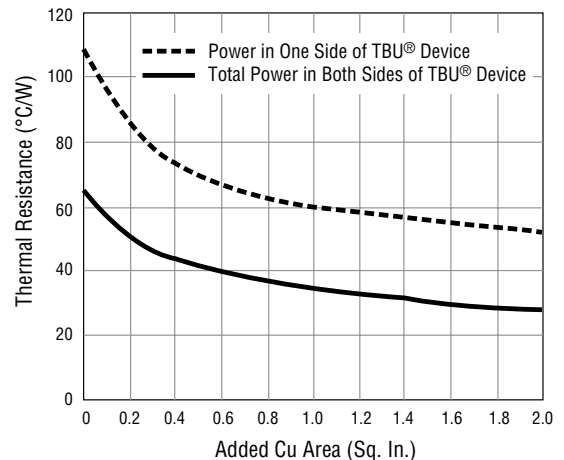

Specifications are subject to change without notice. The device characteristics and parameters in this data sheet can and do vary in different applications and actual device performance may vary over time. Users should verify actual device performance in their specific applications.

# TBU-PL Series - TBU® High-Speed Protectors



## Reflow Profile

Profile Feature	Pb-Free Assembly
Average Ramp-Up Rate (T <sub>smax</sub> to T <sub>p</sub> )	3 °C/sec. max.
Preheat <ul style="list-style-type: none"> <li>- Temperature Min. (T<sub>smin</sub>)</li> <li>- Temperature Max. (T<sub>smax</sub>)</li> <li>- Time (t<sub>smin</sub> to t<sub>smax</sub>)</li> </ul>	150 °C 200 °C 60-180 sec.
Time maintained above: <ul style="list-style-type: none"> <li>- Temperature (T<sub>L</sub>)</li> <li>- Time (t<sub>L</sub>)</li> </ul>	217 °C 60-150 sec.
Peak/Classification Temperature (T <sub>p</sub> )	260 °C
Time within 5 °C of Actual Peak Temp. (t <sub>p</sub> )	20-40 sec.
Ramp-Down Rate	6 °C/sec. max.
Time 25 °C to Peak Temperature	8 min. max.

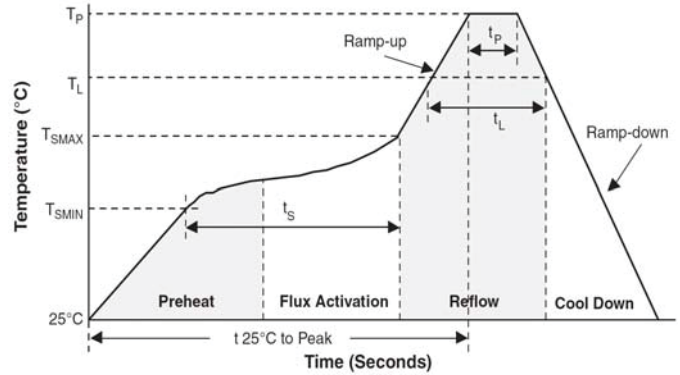

## How to Order

**TBU - PL 085 - 100 - WH**

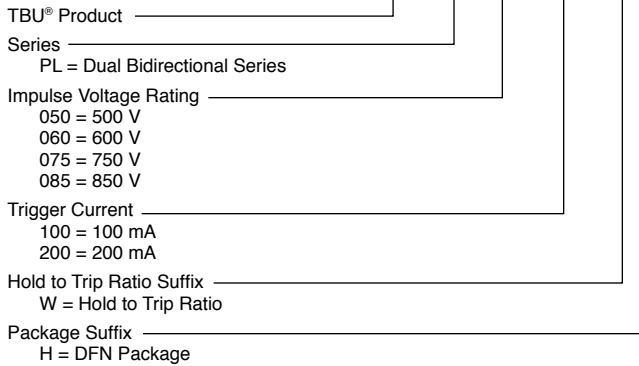

## Typical Part Marking

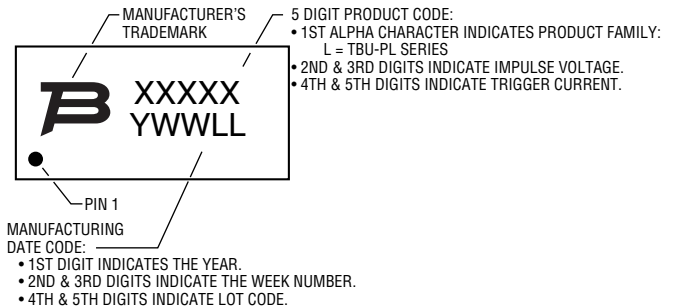

## Device Pin Out

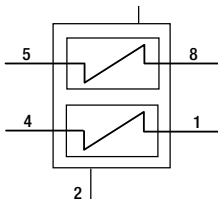

## Pad Designation

Pad #	Pin Out
1	Line 1
2	V <sub>DD</sub> (SLIC Ground or 0 V)
3	Not Used
4	Line 1 SLIC

Pad #	Pin Out
5	Line 2 SLIC
6	V <sub>SS</sub> (SLIC Negative Supply or -V <sub>BAT</sub> )
7	Not Used
8	Line 2

# TBU-PL Series - TBU® High-Speed Protectors

# BOURNS®

## Packaging Specifications

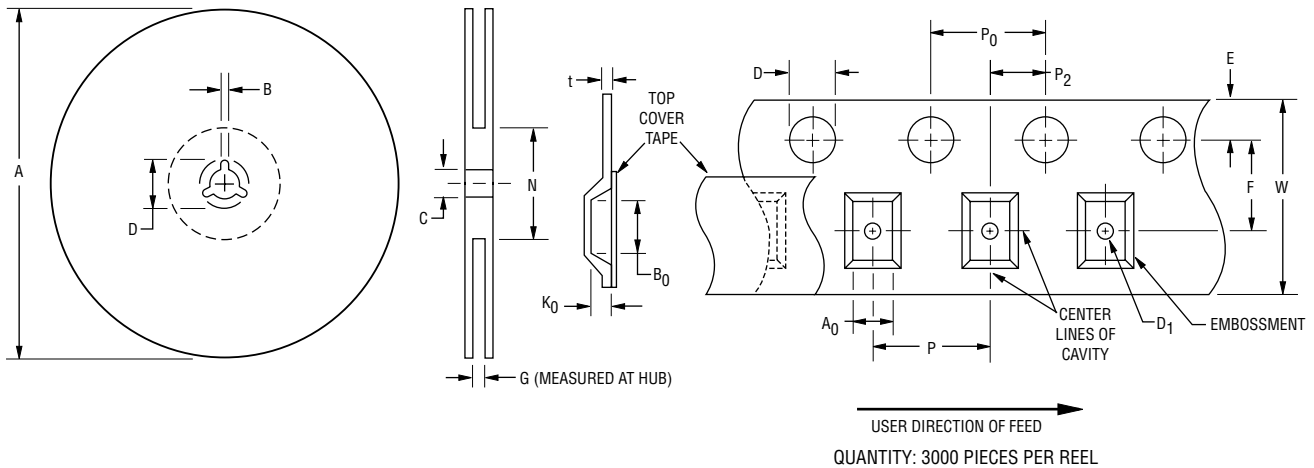

A		B		C		D		G	N
Min.	Max.	Min.	Max.	Min.	Max.	Min.	Max.	Ref.	Ref.
<u>326</u>	<u>330</u>	<u>1.5</u>	<u>2.5</u>	<u>12.8</u>	<u>13.5</u>	<u>20.2</u>	-	<u>16.5</u>	<u>102</u>
(12.835)	(13.002)	(.059)	(.098)	(.504)	(.531)	(.795)		(.650)	(4.016)

A <sub>0</sub>		B <sub>0</sub>		D		D <sub>1</sub>		E		F	
Min.	Max.	Min.	Max.	Min.	Max.	Min.	Max.	Min.	Max.	Min.	max.
<u>4.30</u>	<u>4.50</u>	<u>6.70</u>	<u>6.90</u>	<u>1.5</u>	<u>1.6</u>	<u>1.5</u>	-	<u>1.65</u>	<u>1.85</u>	<u>7.4</u>	<u>7.6</u>
(.169)	(.177)	(.264)	(.272)	(.059)	(.063)	(.059)		(.065)	(.073)	(.291)	(.299)
K <sub>0</sub>		P		P <sub>0</sub>		P <sub>2</sub>		t		W	
Min.	Max.	Min.	Max.	Min.	Max.	Min.	Max.	Min.	Max.	Min.	Max.
<u>1.0</u>	<u>1.2</u>	<u>7.9</u>	<u>8.1</u>	<u>3.9</u>	<u>4.1</u>	<u>1.9</u>	<u>2.1</u>	<u>0.25</u>	<u>0.35</u>	<u>15.7</u>	<u>16.3</u>
(.039)	(.047)	(.311)	(.319)	(.159)	(.161)	(.075)	(.083)	(.010)	(.014)	(.618)	(.642)

DIMENSIONS:  $\frac{\text{MM}}{\text{(INCHES)}}$

# BOURNS®

**Asia-Pacific:** Tel: +886-2 2562-4117 • Email: asiacus@bourns.com

**EMEA:** Tel: +36 88 520 390 • Email: eurocus@bourns.com

**The Americas:** Tel: +1-951 781-5500 • Email: americus@bourns.com

[www.bourns.com](http://www.bourns.com)

REV. 01/17

"TBU" is a registered trademark of Bourns, Inc. in the United States and other countries, except Japan. All references to TBU® in this document for use in Japan shall be deemed to be replaced with Bourns® TBU™.

Specifications are subject to change without notice.

The device characteristics and parameters in this data sheet can and do vary in different applications and actual device performance may vary over time.

Users should verify actual device performance in their specific applications.