

## 阅读申明

- 1.本站收集的数据手册和产品资料都来自互联网，版权归原作者所有。如读者和版权方有任何异议请及时告之，我们将妥善解决。
- 2.本站提供的中文数据手册是英文数据手册的中文翻译，其目的是协助用户阅读，该译文无法自动跟随原稿更新，同时也可能存在翻译上的不当。建议读者以英文原稿为参考以便获得更精准的信息。
- 3.本站提供的产品资料，来自厂商的技术支持或者使用者的心得体会等，其内容可能存在描述上的差异，建议读者做出适当判断。
- 4.如需与我们联系，请发邮件到marketing@iczoom.com，主题请标有“数据手册”字样。

## Read Statement

1. The datasheets and other product information on the site are all from network reference or other public materials, and the copyright belongs to the original author and original published source. If readers and copyright owners have any objections, please contact us and we will deal with it in a timely manner.
2. The Chinese datasheets provided on the website is a Chinese translation of the English datasheets. Its purpose is for reader's learning exchange only and do not involve commercial purposes. The translation cannot be automatically updated with the original manuscript, and there may also be improper translations. Readers are advised to use the English manuscript as a reference for more accurate information.
3. All product information provided on the website refer to solutions from manufacturers' technical support or users the contents may have differences in description, and readers are advised to take the original article as the standard.
4. If you have any questions, please contact us at marketing@iczoom.com and mark the subject with "Datasheets" .

## GENERAL DESCRIPTION

The 8304I is a low skew, 1-to-4 Fanout Buffer. The 8304I is characterized at full 3.3V for input  $V_{DD}$ , and mixed 3.3V and 2.5V for output operating supply modes ( $V_{DDO}$ ). Guaranteed output and part-to-part skew characteristics make the 8304I ideal for those clock distribution applications demanding well defined performance and repeatability.

## FEATURES

- Four LVCMOS / LVTTL outputs
- LVCMOS clock input
- CLK can accept the following input levels: LVCMOS, LVTTL
- Maximum output frequency: 166MHz
- Output skew: 60ps (maximum)
- Part-to-part skew: 650ps (maximum)
- Small 8 lead SOIC package saves board space
- 3.3V input, outputs may be either 3.3V or 2.5V supply modes
- -40°C to 85°C ambient operating temperature
- Available in lead-free (RoHS 6) compliant package

## BLOCK DIAGRAM

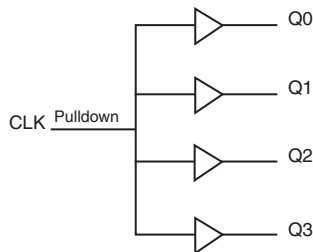

## PIN ASSIGNMENT

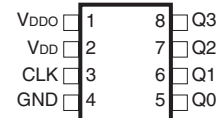

**8304I**  
**8-Lead SOIC**  
 3.8mm x 4.8mm, x 1.47mm package body  
**M Package**  
 Top View

**TABLE 1. PIN DESCRIPTIONS**

Number	Name	Type		Description
1	V <sub>DDO</sub>	Power		Output supply pin. Connect to 3.3V or 2.5V.
2	V <sub>DD</sub>	Power		Positive supply pin. Connect to 3.3V.
3	CLK	Input	Pulldown	LVC MOS / LV TTL clock input.
4	GND	Power		Power supply ground. Connect to ground.
5	Q0	Output		Single clock output. LVC MOS / LV TTL interface levels.
6	Q1	Output		Single clock output. LVC MOS / LV TTL interface levels.
7	Q2	Output		Single clock output. LVC MOS / LV TTL interface levels.
8	Q3	Output		Single clock output. LVC MOS / LV TTL interface levels.

NOTE: *Pulldown* refer to internal input resistors. See Table 2, Pin Characteristics, for typical values.

**TABLE 2. PIN CHARACTERISTICS**

Symbol	Parameter	Test Conditions	Minimum	Typical	Maximum	Units
C <sub>IN</sub>	Input Capacitance				4	pF
C <sub>PD</sub>	Power Dissipation Capacitance (per output)	V <sub>DD</sub> , V <sub>DDO</sub> = 3.465V			15	pF
R <sub>PULLDOWN</sub>	Input Pulldown Resistor			51		kΩ
R <sub>OUT</sub>	Output Impedance			7		Ω

**ABSOLUTE MAXIMUM RATINGS**

Supply Voltage, $V_{DD}$	4.6V
Inputs, $V_I$	-0.5V to $V_{DD} + 0.5V$
Outputs, $V_O$	-0.5V to $V_{DDO} + 0.5V$
Package Thermal Impedance, $\theta_{JA}$	112.7°C/W (0 lfpm)
Storage Temperature, $T_{STG}$	-65°C to 150°C

NOTE: Stresses beyond those listed under Absolute Maximum Ratings may cause permanent damage to the device. These ratings are stress specifications only. Functional operation of product at these conditions or any conditions beyond those listed in the *DC Characteristics* or *AC Characteristics* is not implied. Exposure to absolute maximum rating conditions for extended periods may affect product reliability.

**TABLE 3A. POWER SUPPLY DC CHARACTERISTICS,  $V_{DD} = V_{DDO} = 3.3V \pm 5\%$ ,  $T_A = -40^\circ\text{C}$  TO  $85^\circ\text{C}$** 

Symbol	Parameter	Test Conditions	Minimum	Typical	Maximum	Units
$V_{DD}$	Power Supply Voltage		3.135	3.3	3.465	V
$V_{DDO}$	Output Power Supply Voltage		3.135	3.3	3.465	V
$I_{DD}$	Power Supply Current				18	mA
$I_{DDO}$	Output Supply Current				11	mA

**TABLE 3B. POWER SUPPLY DC CHARACTERISTICS,  $V_{DD} = 3.3V \pm 5\%$ ,  $V_{DDO} = 2.5V \pm 5\%$ ,  $T_A = -40^\circ\text{C}$  TO  $85^\circ\text{C}$** 

Symbol	Parameter	Test Conditions	Minimum	Typical	Maximum	Units
$V_{DD}$	Positive Supply Voltage		3.135	3.3	3.465	V
$V_{DDO}$	Output Supply Voltage		2.375	2.5	2.625	V
$I_{DD}$	Power Supply Current				18	mA
$I_{DDO}$	Output Supply Current				11	mA

**TABLE 3C. LVCMOS / LVTTTL DC CHARACTERISTICS,  $V_{DD} = V_{DDO} = 3.3V \pm 5\%$ ,  $T_A = -40^\circ\text{C}$  TO  $85^\circ\text{C}$** 

Symbol	Parameter	Test Conditions	Minimum	Typical	Maximum	Units
$V_{IH}$	Input High Voltage		2		$V_{DD} + 0.3$	V
$V_{IL}$	Input Low Voltage		-0.3		1.3	V
$I_{IH}$	Input High Current	$V_{DD} = V_{IN} = 3.465V$			150	$\mu\text{A}$
$I_{IL}$	Input Low Current	$V_{DD} = 3.465V, V_{IN} = 0V$	-5			$\mu\text{A}$
$V_{OH}$	Output High Voltage	Refer to NOTE 1	2.6			V
		$I_{OH} = -16\text{mA}$	2.9			V
		$I_{OH} = -100\mu\text{A}$	3			V
$V_{OL}$	Output Low Voltage	Refer to NOTE 1			0.5	V
		$I_{OL} = 16\text{mA}$			0.25	V
		$I_{OL} = 100\mu\text{A}$			0.15	V

NOTE 1: Outputs terminated with  $50\Omega$  to  $V_{DDO}/2$ . See Parameter Measurement Section, "3.3V Output Load Test Circuit".

**TABLE 3D. LVCMOS / LVTTTL DC CHARACTERISTICS,  $V_{DD} = 3.3V \pm 5\%$ ,  $V_{DDO} = 2.5V \pm 5\%$ ,  $T_A = -40^\circ C$  TO  $85^\circ C$** 

Symbol	Parameter	Test Conditions	Minimum	Typical	Maximum	Units
$V_{IH}$	Input High Voltage		2		$V_{DD} + 0.3$	V
$V_{IL}$	Input Low Voltage		-0.3		1.3	V
$I_{IH}$	Input High Current	$V_{DD} = V_{IN} = 3.465V$			150	$\mu A$
$I_{IL}$	Input Low Current	$V_{DD} = 3.465V, V_{IN} = 0V$	-5			$\mu A$
$V_{OH}$	Output High Voltage; NOTE 1		2.1			V
$V_{OL}$	Output Low Voltage; NOTE 1				0.5	V

NOTE 1: Outputs terminated with  $50\Omega$  to  $V_{DDO}/2$ . See Parameter Measurement Section, "3.3V/2.5V Output Load Test Circuit".

**TABLE 4A. AC CHARACTERISTICS,  $V_{DD} = V_{DDO} = 3.3V \pm 5\%$ ,  $T_A = -40^\circ C$  TO  $85^\circ C$** 

Symbol	Parameter	Test Conditions	Minimum	Typical	Maximum	Units
$f_{MAX}$	Output Frequency				166	MHz
$t_{pLH}$	Propagation Delay, Low-to-High; NOTE 1	$f \leq 166MHz$	2		3.3	ns
$t_{jit}$	Buffer Additive Phase Jitter, RMS; refer to Additive Phase Jitter Section	125MHz, Integration Range 12kHz – 20MHz		0.17		ps
$tsk(o)$	Output Skew; NOTE 2, 4	$f = 133MHz$			50	ps
$tsk(pp)$	Part-to-Part Skew; NOTE 3, 4				600	ps
$t_R$	Output Rise Time	30% to 70%	250		500	ps
$t_F$	Output Fall Time	30% to 70%	250		500	ps
odc	Output Duty Cycle		40		60	%

NOTE: Electrical parameters are guaranteed over the specified ambient operating temperature range, which is established when the device is mounted in a test socket with maintained transverse airflow greater than 500 lfpm. The device will meet specifications after thermal equilibrium has been reached under these conditions.

NOTE: All parameters measured at 166MHz unless noted otherwise.

NOTE 1: Measured from  $V_{DD}/2$  of the input to  $V_{DDO}/2$  of the output.

NOTE 2: Defined as skew between outputs at the same supply voltage and with equal load conditions.

Measured at  $V_{DDO}/2$ .

NOTE 3: Defined as skew between outputs on different devices operating at the same supply voltages and with equal load conditions. Using the same type of inputs on each device, the outputs are measured

at  $V_{DDO}/2$ .

NOTE 4: This parameter is defined in accordance with JEDEC Standard 65.

**TABLE 4B. AC CHARACTERISTICS,  $V_{DD} = 3.3V \pm 5\%$ ,  $V_{DDO} = 2.5V \pm 5\%$ ,  $T_A = -40^\circ\text{C}$  TO  $85^\circ\text{C}$** 

Symbol	Parameter	Test Conditions	Minimum	Typical	Maximum	Units
$f_{MAX}$	Output Frequency				166	MHz
$t_{p_{LH}}$	Propagation Delay, Low-to-High; NOTE 1	$f \leq 166\text{MHz}$	2.3		3.7	ns
$t_{sk(o)}$	Output Skew; NOTE 2, 4	$f = 133\text{MHz}$			60	ps
$t_{sk(pp)}$	Part-to-Part Skew; NOTE 3, 4				650	ps
$t_R$	Output Rise Time	30% to 70%	250		500	ps
$t_F$	Output Fall Time	30% to 70%	250		500	ps
odc	Output Duty Cycle		40		60	%

NOTE: Electrical parameters are guaranteed over the specified ambient operating temperature range, which is established when the device is mounted in a test socket with maintained transverse airflow greater than 500 lfm. The device will meet specifications after thermal equilibrium has been reached under these conditions.

All parameters measured at 166MHz unless noted otherwise.

NOTE 1: Measured from  $V_{DD}/2$  of the input to  $V_{DDO}/2$  of the output.

NOTE 2: Defined as skew between outputs at the same supply voltage and with equal load conditions. Measured at  $V_{DDO}/2$ .

NOTE 3: Defined as skew between outputs on different devices operating at the same supply voltages and with equal load conditions. Using the same type of inputs on each device, the outputs are measured at  $V_{DDO}/2$ .

NOTE 4: This parameter is defined in accordance with JEDEC Standard 65.

## ADDITIVE PHASE JITTER

The spectral purity in a band at a specific offset from the fundamental compared to the power of the fundamental is called the **dBc Phase Noise**. This value is normally expressed using a Phase noise plot and is most often the specified plot in many applications. Phase noise is defined as the ratio of the noise power present in a 1Hz band at a specified offset from the fundamental frequency to the power value of the fundamental. This ratio is expressed in decibels

(dBm) or a ratio of the power in the 1Hz band to the power in the fundamental. When the required offset is specified, the phase noise is called a **dBc** value, which simply means dBm at a specified offset from the fundamental. By investigating jitter in the frequency domain, we get a better understanding of its effects on the desired application over the entire time record of the signal. It is mathematically possible to calculate an expected bit error rate given a phase noise plot.

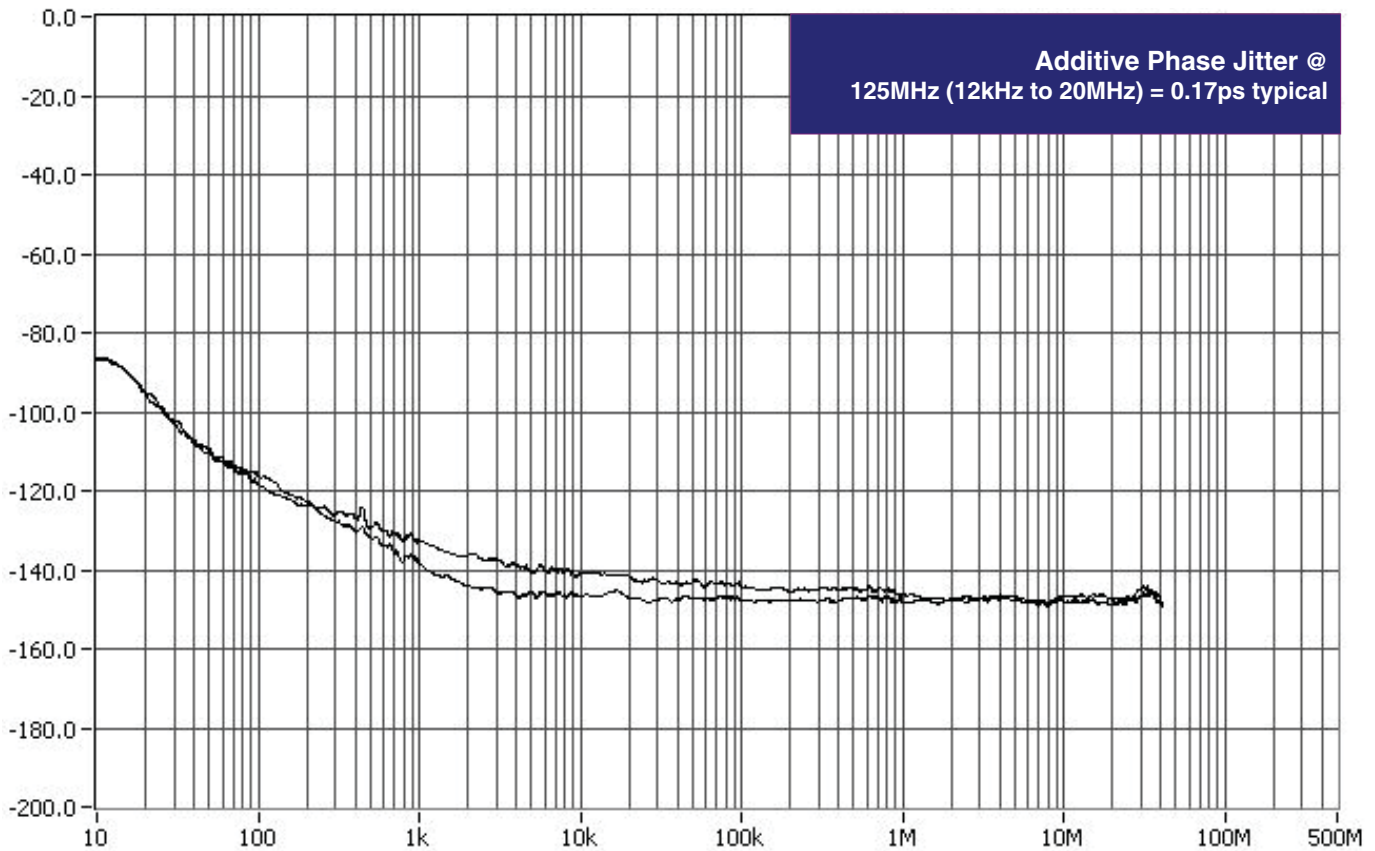

As with most timing specifications, phase noise measurements has issues relating to the limitations of the equipment. Often the noise floor of the equipment is higher than the noise floor of the device.

This is illustrated above. The device meets the noise floor of what is shown, but can actually be lower. The phase noise is dependent on the input source and measurement equipment.

# PARAMETER MEASUREMENT INFORMATION

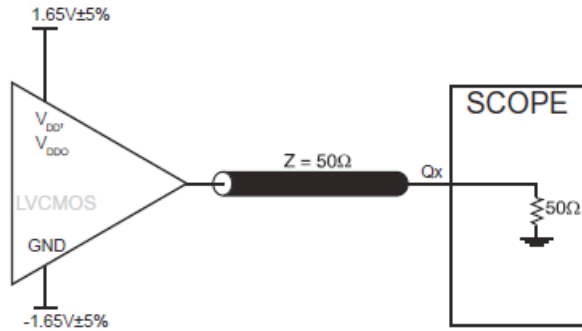
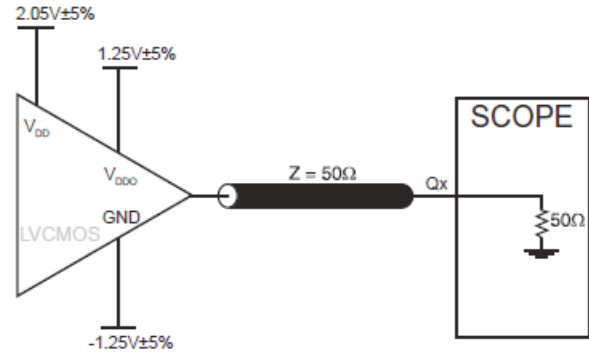
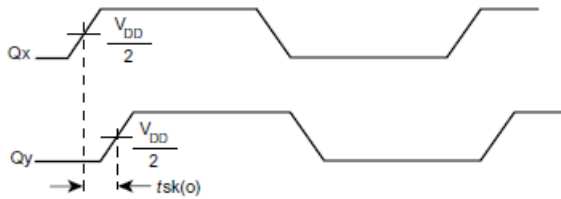
**3.3V OUTPUT LOAD AC TEST CIRCUIT**

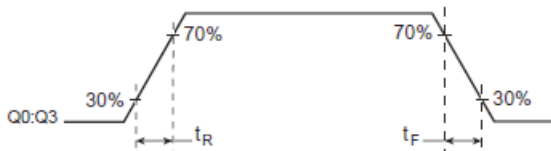
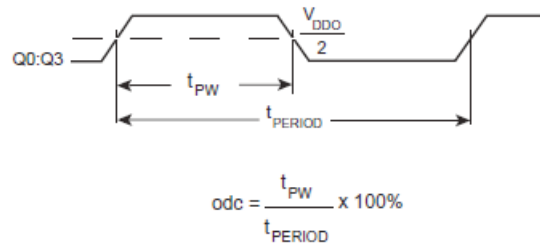
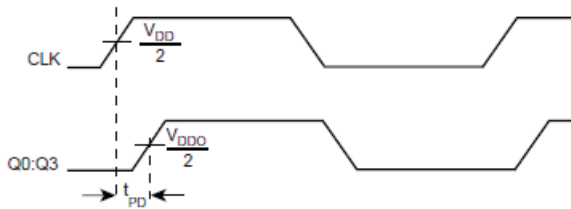
**2.5V OUTPUT LOAD AC TEST CIRCUIT**

**OUTPUT SKEW**

**PART-TO-PART SKEW**

**OUTPUT RISE/FALL TIME**

**OUTPUT DUTY CYCLE/PULSE WIDTH/PERIOD**

**PROPAGATION DELAY**



## RELIABILITY INFORMATION

**TABLE 5.  $\theta_{JA}$  vs. AIR FLOW TABLE**

$\theta_{JA}$ by Velocity (Linear Feet per Minute)			
	0	200	500
Single-Layer PCB, JEDEC Standard Test Boards	153.3°C/W	128.5°C/W	115.5°C/W
Multi-Layer PCB, JEDEC Standard Test Boards	112.7°C/W	103.3°C/W	97.1°C/W

**NOTE:** Most modern PCB designs use multi-layered boards. The data in the second row pertains to most designs.

**TRANSISTOR COUNT**

The transistor count for 8304I is: 416

## PACKAGE OUTLINE AND DIMENSIONS

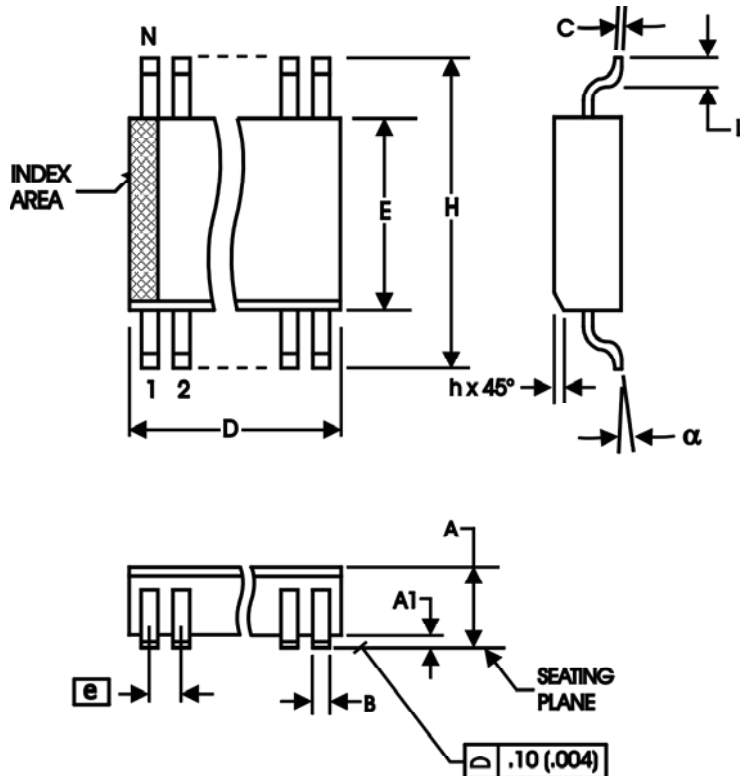
**PACKAGE OUTLINE - SUFFIX M FOR 8 LEAD SOIC**

**TABLE 6. PACKAGE DIMENSIONS - SUFFIX M**

SYMBOL	Millimeters	
	MINIMUM	MAXIMUM
N	8	
A	1.35	1.75
A1	0.10	0.25
B	0.33	0.51
C	0.19	0.25
D	4.80	5.00
E	3.80	4.00
e	1.27 BASIC	
H	5.80	6.20
h	0.25	0.50
L	0.40	1.27
$\alpha$	0°	8°

Reference Document: JEDEC Publication 95, MS-012

**TABLE 7. ORDERING INFORMATION**

<b>Part/Order Number</b>	<b>Marking</b>	<b>Package</b>	<b>Shipping Packaging</b>	<b>Temperature</b>
8304AMILF	8304AMIL	8 lead "Lead Free" SOIC	Tube	-40°C to +85°C
8304AMILFT	8304AMIL	8 lead "Lead Free" SOIC	Tape and Reel	-40°C to +85°C

REVISION HISTORY SHEET				
Rev	Table	Page	Description of Change	Date
B	3B	3	LVC MOS/LVTTL DC Characteristics Table, added $I_{OH}$ and $I_{OL}$ Test Conditions to $V_{OH}$ and $V_{OL}$ rows.	4/4/02
B	T7	1 8	Features Section - added lead-free bullet. Ordering Information Table - added lead-free part number, marking and note. Updated datasheet format.	11/09/06
C	T4A T7	4 6 9	3.3V AC Characteristics Table - added Buffer Additive Phase Jitter spec. Added Buffer Additive Phase Jitter Plot. Ordering Information - Deleted "ICS" from the Part/Order number column.	2/11/09
D	T1 T2	1 2 2	Pin Assignment - corrected "pullup" label to "pulldown" label. Pin Description Table - deleted pullup from note. Pin Characteristics Table - deleted Rpullup row.	10/29/10
D	T7	9	Removed ICS in the part numbers. Removed LF note at the bottom of the Ordering Information table. Removed the quantity of 2500 from the Tape & Reel in the Ordering information table. Updated datasheet header and footer.	12/10/15



Corporate Headquarters  
6024 Silver Creek Valley Road  
San Jose, CA 95138 USA  
[www.IDT.com](http://www.IDT.com)

Sales  
1-800-345-7015 or 408-284-8200  
Fax: 408-284-2775  
[www.IDT.com/go/sales](http://www.IDT.com/go/sales)

Tech Support  
[www.idt.com/go/support](http://www.idt.com/go/support)

DISCLAIMER Integrated Device Technology, Inc. (IDT) reserves the right to modify the products and/or specifications described herein at any time, without notice, at IDT's sole discretion. Performance specifications and operating parameters of the described products are determined in an independent state and are not guaranteed to perform the same way when installed in customer products. The information contained herein is provided without representation or warranty of any kind, whether express or implied, including, but not limited to, the suitability of IDT's products for any particular purpose, an implied warranty of merchantability, or non-infringement of the intellectual property rights of others. This document is presented only as a guide and does not convey any license under intellectual property rights of IDT or any third parties.

IDT's products are not intended for use in applications involving extreme environmental conditions or in life support systems or similar devices where the failure or malfunction of an IDT product can be reasonably expected to significantly affect the health or safety of users. Anyone using an IDT product in such a manner does so at their own risk, absent an express, written agreement by IDT.

Integrated Device Technology, IDT and the IDT logo are trademarks or registered trademarks of IDT and its subsidiaries in the United States and other countries. Other trademarks used herein are the property of IDT or their respective third party owners.

For datasheet type definitions and a glossary of common terms, visit [www.idt.com/go/glossary](http://www.idt.com/go/glossary).

Copyright ©2015 Integrated Device Technology, Inc. All rights reserved.