

## 阅读申明

- 1.本站收集的数据手册和产品资料都来自互联网，版权归原作者所有。如读者和版权方有任何异议请及时告之，我们将妥善解决。
- 2.本站提供的中文数据手册是英文数据手册的中文翻译，其目的是协助用户阅读，该译文无法自动跟随原稿更新，同时也可能存在翻译上的不当。建议读者以英文原稿为参考以便获得更精准的信息。
- 3.本站提供的产品资料，来自厂商的技术支持或者使用者的心得体会等，其内容可能存在描述上的差异，建议读者做出适当判断。
- 4.如需与我们联系，请发邮件到marketing@iczoom.com，主题请标有“数据手册”字样。

## Read Statement

1. The datasheets and other product information on the site are all from network reference or other public materials, and the copyright belongs to the original author and original published source. If readers and copyright owners have any objections, please contact us and we will deal with it in a timely manner.
2. The Chinese datasheets provided on the website is a Chinese translation of the English datasheets. Its purpose is for reader's learning exchange only and do not involve commercial purposes. The translation cannot be automatically updated with the original manuscript, and there may also be improper translations. Readers are advised to use the English manuscript as a reference for more accurate information.
3. All product information provided on the website refer to solutions from manufacturers' technical support or users the contents may have differences in description, and readers are advised to take the original article as the standard.
4. If you have any questions, please contact us at marketing@iczoom.com and mark the subject with "Datasheets" .

### FEATURES

- 95 ps propagation delay
- 7.5 GHz toggle rate
- 60 ps typical output rise/fall
- 60 fs random jitter (RJ)
- On-chip terminations at both input pins
- Extended industrial temperature range:  $-40^{\circ}\text{C}$  to  $+125^{\circ}\text{C}$
- 2.5 V to 3.3 V power supply ( $V_{CC} - V_{EE}$ )

### APPLICATIONS

- Clock and data signal restoration and level shifting
- Automated test equipment (ATE)
- High speed instrumentation
- High speed line receivers
- Threshold detection
- Converter clocking

### GENERAL DESCRIPTION

The ADCLK905 (one input, one output), ADCLK907 (dual one input, one output), and ADCLK925 (one input, two outputs) are ultrafast clock/data buffers fabricated on the Analog Devices, Inc., proprietary XFCB3 silicon germanium (SiGe) bipolar process.

The ADCLK905/ADCLK907/ADCLK925 feature full-swing emitter coupled logic (ECL) output drivers. For PECL (positive ECL) operation, bias  $V_{CC}$  to the positive supply and  $V_{EE}$  to ground. For NECL (negative ECL) operation, bias  $V_{CC}$  to ground and  $V_{EE}$  to the negative supply.

The buffers offer 95 ps propagation delay, 7.5 GHz toggle rate, 10 Gbps data rate, and 60 fs random jitter (RJ).

The inputs have center tapped,  $100\ \Omega$ , on-chip termination resistors. A  $V_{REF}$  pin is available for biasing ac-coupled inputs.

The ECL output stages are designed to directly drive 800 mV each side into  $50\ \Omega$  terminated to  $V_{CC} - 2\ \text{V}$  for a total differential output swing of 1.6 V.

The ADCLK905/ADCLK907/ADCLK925 are available in 16-lead LFCSP packages.

### TYPICAL APPLICATION CIRCUITS

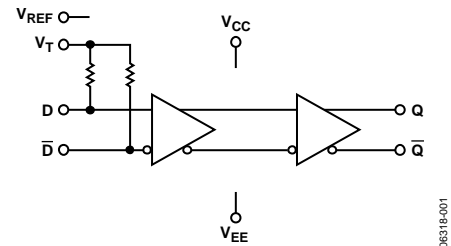

Figure 1. ADCLK905 ECL 1:1 Clock/Data Buffer

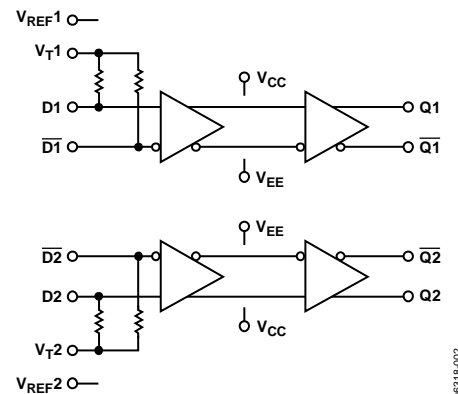

Figure 2. ADCLK907 ECL Dual 1:1 Clock/Data Buffer

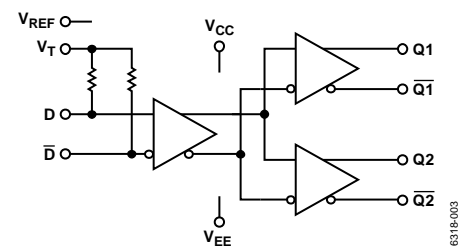

Figure 3. ADCLK925 ECL 1:2 Clock/Data Fanout Buffer

## TABLE OF CONTENTS

Features .....	1	Typical Performance Characteristics .....	9
Applications.....	1	Applications Information .....	12
General Description .....	1	Power/Ground Layout and Bypassing .....	12
Typical Application Circuits.....	1	Output Stages .....	12
Revision History .....	2	Optimizing High Speed Performance .....	12
Specifications.....	3	Buffer Random Jitter .....	12
Electrical Characteristics .....	3	Typical Application Circuits .....	13
Absolute Maximum Ratings.....	5	Evaluation Board Schematic .....	14
Thermal Resistance .....	5	Outline Dimensions .....	15
ESD Caution.....	5	Ordering Guide .....	15
Pin Configurations and Function Descriptions .....	6		

## REVISION HISTORY

### 2/2017—Rev. A to Rev. B

Changes to Figure 4 and Table 4.....	6
Changes to Figure 5 and Table 5.....	7
Changes to Figure 6 and Table 6.....	8

### 8/2016—Rev. 0 to Rev. A

Changed CP-16-3 to CP-16-27 .....	Throughout
Changes to Figure 4 and Table 4.....	6
Changes to Figure 5 and Table 5.....	7
Changes to Figure 6 and Table 6.....	8
Updated Outline Dimensions .....	15
Changes to Ordering Guide .....	15

### 8/2007—Revision 0: Initial Version

## SPECIFICATIONS

## ELECTRICAL CHARACTERISTICS

Typical (Typ) values are given for  $V_{CC} - V_{EE} = 3.3\text{ V}$  and  $T_A = 25^\circ\text{C}$ , unless otherwise noted. Minimum (Min) and maximum (Max) values are given over the full  $V_{CC} - V_{EE} = 3.3\text{ V} \pm 10\%$  and  $T_A = -40^\circ\text{C}$  to  $+125^\circ\text{C}$  variation, unless otherwise noted.

Table 1.

Parameter	Symbol	Min	Typ	Max	Unit	Test Conditions/Comments
DC INPUT CHARACTERISTICS						
Input Voltage High Level	$V_{IH}$	$V_{EE} + 1.6$		$V_{CC}$	V	
Input Voltage Low Level	$V_{IL}$	$V_{EE}$		$V_{CC} - 0.7$	V	
Input Differential Range	$V_{ID}$	0.2		3.4	V p-p	$-40^\circ\text{C}$ to $+85^\circ\text{C}$ ( $\pm 1.7\text{ V}$ between input pins)
	$V_{ID}$	0.2		2.8	V p-p	$85^\circ\text{C}$ to $125^\circ\text{C}$ ( $\pm 1.4\text{ V}$ between input pins)
Input Capacitance	$C_{IN}$		0.4		pF	
Input Resistance, Single-Ended Mode			50		$\Omega$	
Input Resistance, Differential Mode			100		$\Omega$	
Input Resistance, Common Mode			50		k $\Omega$	Open $V_T$
Input Bias Current			20		$\mu\text{A}$	
DC OUTPUT CHARACTERISTICS						
Output Voltage High Level	$V_{OH}$	$V_{CC} - 1.26$		$V_{CC} - 0.76$	V	$50\ \Omega$ to $(V_{CC} - 2.0\text{ V})$
Output Voltage Low Level	$V_{OL}$	$V_{CC} - 1.99$		$V_{CC} - 1.54$	V	$50\ \Omega$ to $(V_{CC} - 2.0\text{ V})$
Output Voltage Differential	$V_{OD}$	610		1040	mV	$50\ \Omega$ to $(V_{CC} - 2.0\text{ V})$
Reference Voltage	$V_{REF}$					
Output Voltage			$(V_{CC} + 1)/2$		V	$-500\ \mu\text{A}$ to $+500\ \mu\text{A}$
Output Resistance			250		$\Omega$	
AC PERFORMANCE						
Propagation Delay	$t_{PD}$	70	95	125	ps	$V_{CC} = 3.3\text{ V} \pm 10\%$ , $V_{ICM} = V_{REF}$ , $V_{ID} = 0.5\text{ V p-p}$
		70	95	125	ps	$V_{CC} = 2.5\text{ V} \pm 5\%$ , $V_{ICM} = V_{REF}$ , $V_{ID} = 0.5\text{ V p-p}$
Propagation Delay Temperature Coefficient			50		fs/ $^\circ\text{C}$	
Propagation Delay Skew (Output to Output) ADCLK907				15	ps	$V_{ID} = 0.5\text{ V}$
Propagation Delay Skew (Output to Output) ADCLK925				10	ps	$V_{ID} = 0.5\text{ V}$
Propagation Delay Skew (Device to Device) Toggle Rate		6	7.5	35	ps	$V_{ID} = 0.5\text{ V}$
			6.5		GHz	$>0.8\text{ V}$ differential output swing, $V_{CC} = 3.3\text{ V} \pm 10\%$
					GHz	$>0.8\text{ V}$ differential output swing, $V_{CC} = 2.5\text{ V} \pm 5\%$
Random Jitter	RJ		60		fs rms	$V_{ID} = 1600\text{ mV}$ , $8\text{ V/ns}$ , $V_{ICM} = 1.85\text{ V}$
Rise/Fall Time	$t_R/t_F$	30		85	ps	20%/80%
Additive Phase Noise						
622.08 MHz			-138		dBc/Hz	@10 Hz offset
			-144		dBc/Hz	@100 Hz offset
			-152		dBc/Hz	@1 kHz offset
			-159		dBc/Hz	@10 kHz offset
			-161		dBc/Hz	@100 kHz offset
			-161		dBc/Hz	>1 MHz offset
122.88 MHz			-135		dBc/Hz	@10 Hz offset
			-145		dBc/Hz	@100 Hz offset
			-153		dBc/Hz	@1 kHz offset
			-160		dBc/Hz	@10 kHz offset
			-161		dBc/Hz	@100 kHz offset
			-161		dBc/Hz	>1 MHz offset

Parameter	Symbol	Min	Typ	Max	Unit	Test Conditions/Comments
POWER SUPPLY						
Supply Voltage Requirement	$V_{CC} - V_{EE}$	2.375		3.63	V	2.5 V – 5% to 3.3 V + 10%
Power Supply Current						Static
ADCLK905						
Negative Supply Current	$I_{VEE}$		24		mA	$V_{CC} - V_{EE} = 2.5\text{ V}$
			25	40	mA	$V_{CC} - V_{EE} = 3.3\text{ V} \pm 10\%$
Positive Supply Current	$I_{VCC}$		47		mA	$V_{CC} - V_{EE} = 2.5\text{ V}$
			48	63	mA	$V_{CC} - V_{EE} = 3.3\text{ V} \pm 10\%$
ADCLK907						
Negative Supply Current	$I_{VEE}$		48		mA	$V_{CC} - V_{EE} = 2.5\text{ V}$
			50	80	mA	$V_{CC} - V_{EE} = 3.3\text{ V} \pm 10\%$
Positive Supply Current	$I_{VCC}$		94		mA	$V_{CC} - V_{EE} = 2.5\text{ V}$
			96	126	mA	$V_{CC} - V_{EE} = 3.3\text{ V} \pm 10\%$
ADCLK925						
Negative Supply Current	$I_{VEE}$		29		mA	$V_{CC} - V_{EE} = 2.5\text{ V}$
			31	51	mA	$V_{CC} - V_{EE} = 3.3\text{ V} \pm 10\%$
Positive Supply Current	$I_{VCC}$		76		mA	$V_{CC} - V_{EE} = 2.5\text{ V}$
			77	97	mA	$V_{CC} - V_{EE} = 3.3\text{ V} \pm 10\%$
Power Supply Rejection <sup>1</sup>	$PSR_{VCC}$		3		ps/V	$V_{CC} - V_{EE} = 3.0\text{ V} \pm 20\%$
Output Swing Supply Rejection <sup>2</sup>	$PSR_{VCC}$		26		dB	$V_{CC} - V_{EE} = 3.0\text{ V} \pm 20\%$

<sup>1</sup> Change in  $T_{PD}$  per change in  $V_{CC}$ .<sup>2</sup> Change in output swing per change in  $V_{CC}$ .

## ABSOLUTE MAXIMUM RATINGS

Table 2.

Parameter	Rating
Supply Voltage $V_{CC} - V_{EE}$	6.0V
Input Voltage D (D1, D2), $\overline{D}$ ( $\overline{D1}$ , $\overline{D2}$ )	$V_{EE} - 0.5\text{ V}$ to $V_{CC} + 0.5\text{ V}$
D1, D2, $\overline{D1}$ , $\overline{D2}$ to $V_T$ Pin (CML or PECL Termination)	$\pm 40\text{ mA}$
D (D1, D2) to $\overline{D}$ ( $\overline{D1}$ , $\overline{D2}$ )	$\pm 1.8\text{ V}$
Maximum Voltage on Output Pins	$V_{CC} + 0.5\text{ V}$
Maximum Output Current	35 mA
Input Termination, $V_T$ to D (D1, D2), $\overline{D}$ ( $\overline{D1}$ , $\overline{D2}$ )	$\pm 2\text{ V}$
Voltage Reference, $V_{REF}$	$V_{CC} - V_{EE}$
Temperature	
Operating Temperature Range, Ambient	$-40^\circ\text{C}$ to $+125^\circ\text{C}$
Operating Temperature, Junction	$150^\circ\text{C}$
Storage Temperature Range	$-65^\circ\text{C}$ to $+150^\circ\text{C}$

Stresses at or above those listed under Absolute Maximum Ratings may cause permanent damage to the product. This is a stress rating only; functional operation of the product at these or any other conditions above those indicated in the operational section of this specification is not implied. Operation beyond the maximum operating conditions for extended periods may affect product reliability.

## THERMAL RESISTANCE

$\theta_{JA}$  is specified for the worst-case conditions, that is, a device soldered in a circuit board for surface-mount packages.

Table 3. Thermal Resistance

Package Type	$\theta_{JA}$	Unit
16-Lead LFCSP	70	$^\circ\text{C}/\text{W}$

## ESD CAUTION



**ESD (electrostatic discharge) sensitive device.** Charged devices and circuit boards can discharge without detection. Although this product features patented or proprietary protection circuitry, damage may occur on devices subjected to high energy ESD. Therefore, proper ESD precautions should be taken to avoid performance degradation or loss of functionality.

## PIN CONFIGURATIONS AND FUNCTION DESCRIPTIONS

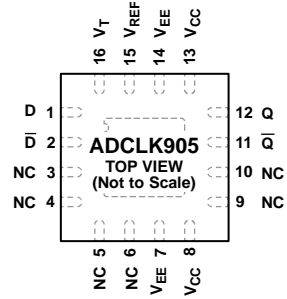

## NOTES

1. NC = NO CONNECT. DO NOT CONNECT TO THIS PIN.
2. EXPOSED PAD. THE EXPOSED PAD IS NOT ELECTRICALLY CONNECTED TO ANY PART OF THE CIRCUIT. IT CAN BE LEFT FLOATING FOR OPTIMAL ELECTRICAL ISOLATION BETWEEN THE PACKAGE HANDLE AND THE SUBSTRATE OF THE DIE. IT CAN ALSO BE SOLDERED TO THE APPLICATION BOARD IF IMPROVED THERMAL AND/OR MECHANICAL STABILITY IS DESIRED. EXPOSED METAL AT THE CORNERS OF THE PACKAGE IS CONNECTED TO THIS EXPOSED PAD. ALLOW SUFFICIENT CLEARANCE TO VIAS AND OTHER COMPONENTS.

06318-004

Figure 4. ADCLK905 Pin Configuration

Table 4. Pin Function Descriptions for 1:1 ADCLK905 Buffer

Pin No.	Mnemonic	Description
1	D	Noninverting Input.
2	$\overline{D}$	Inverting Input.
3, 4, 5, 6, 9, 10	NC	No Connect. No physical connection to the die.
7, 14	$V_{EE}$	Negative Supply Voltage.
8, 13	$V_{CC}$	Positive Supply Voltage.
11	$\overline{Q}$	Inverting Output.
12	Q	Noninverting Output.
15	$V_{REF}$	Reference Voltage. Reference voltage for biasing ac-coupled inputs.
16	$V_T$	Center Tap. Center tap of 100 $\Omega$ input resistor.
	EPAD	Exposed Pad. The exposed pad is not electrically connected to any part of the circuit. It can be left floating for optimal electrical isolation between the package handle and the substrate of the die. It can also be soldered to the application board if improved thermal and/or mechanical stability is desired. Exposed metal at the corners of the package is connected to this exposed pad. Allow sufficient clearance to vias and other components.

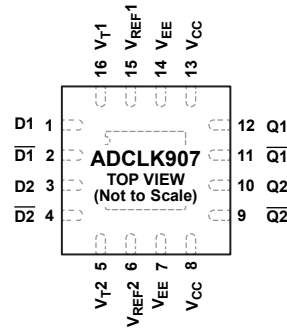

**NOTES**

1. EXPOSED PAD. THE EXPOSED PAD IS NOT ELECTRICALLY CONNECTED TO ANY PART OF THE CIRCUIT. IT CAN BE LEFT FLOATING FOR OPTIMAL ELECTRICAL ISOLATION BETWEEN THE PACKAGE HANDLE AND THE SUBSTRATE OF THE DIE. IT CAN ALSO BE SOLDERED TO THE APPLICATION BOARD IF IMPROVED THERMAL AND/OR MECHANICAL STABILITY IS DESIRED. EXPOSED METAL AT THE CORNERS OF THE PACKAGE IS CONNECTED TO THIS EXPOSED PAD. ALLOW SUFFICIENT CLEARANCE TO VIAS AND OTHER COMPONENTS.

063118-005

Figure 5. ADCLK907 Pin Configuration

Table 5. Pin Function Descriptions for Dual 1:1 ADCLK907 Buffer

Pin No.	Mnemonic	Description
1	D1	Noninverting Input 1.
2	$\overline{D1}$	Inverting Input 1.
3	D2	Noninverting Input 2.
4	$\overline{D2}$	Inverting Input 2.
5	VT2	Center Tap 2. Center tap of 100 $\Omega$ input resistor, Channel 2.
6	VREF2	Reference Voltage 2. Reference voltage for biasing ac-coupled inputs, Channel 2.
7, 14	VEE	Negative Supply Voltage.
8, 13	VCC	Positive Supply Voltage. Pin 8 and Pin 13 are not strapped internally.
9	$\overline{Q2}$	Inverting Output 2.
10	Q2	Noninverting Output 2.
11	$\overline{Q1}$	Inverting Output 1.
12	Q1	Noninverting Output 1.
15	VREF1	Reference Voltage 1. Reference voltage for biasing ac-coupled inputs, Channel 1.
16	VT1	Center Tap 1. Center tap of 100 $\Omega$ input resistor, Channel 1.
	EPAD	Exposed Pad. The exposed pad is not electrically connected to any part of the circuit. It can be left floating for optimal electrical isolation between the package handle and the substrate of the die. It can also be soldered to the application board if improved thermal and/or mechanical stability is desired. Exposed metal at the corners of the package is connected to this exposed pad. Allow sufficient clearance to vias and other components.



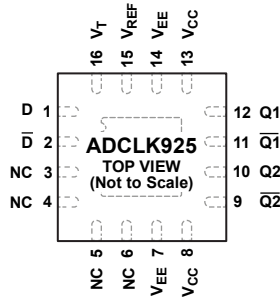

**NOTES**

1. NC = NO CONNECT. DO NOT CONNECT TO THIS PIN.
2. EXPOSED PAD. THE EXPOSED PAD IS NOT ELECTRICALLY CONNECTED TO ANY PART OF THE CIRCUIT. IT CAN BE LEFT FLOATING FOR OPTIMAL ELECTRICAL ISOLATION BETWEEN THE PACKAGE HANDLE AND THE SUBSTRATE OF THE DIE. IT CAN ALSO BE SOLDERED TO THE APPLICATION BOARD IF IMPROVED THERMAL AND/OR MECHANICAL STABILITY IS DESIRED. EXPOSED METAL AT THE CORNERS OF THE PACKAGE IS CONNECTED TO THIS EXPOSED PAD. ALLOW SUFFICIENT CLEARANCE TO VIAS AND OTHER COMPONENTS.

06318-006

Figure 6. ADCLK925 Pin Configuration

Table 6. Pin Function Descriptions for 1:2 ADCLK925 Buffer

Pin No.	Mnemonic	Description
1	D	Noninverting Input.
2	$\overline{D}$	Inverting Input.
3, 4, 5, 6	NC	No Connect. No physical connection to the die.
7, 14	$V_{EE}$	Negative Supply Voltage.
8, 13	$V_{CC}$	Positive Supply Voltage.
9	$\overline{Q2}$	Inverting Output 2.
10	$Q2$	Noninverting Output 2.
11	$\overline{Q1}$	Inverting Output 1.
12	$Q1$	Noninverting Output 1.
15	$V_{REF}$	Reference Voltage. Reference voltage for biasing ac-coupled inputs.
16	$V_T$	Center Tap. Center tap of 100 $\Omega$ input resistor.
	EPAD	Exposed Pad. The exposed pad is not electrically connected to any part of the circuit. It can be left floating for optimal electrical isolation between the package handle and the substrate of the die. It can also be soldered to the application board if improved thermal and/or mechanical stability is desired. Exposed metal at the corners of the package is connected to this exposed pad. Allow sufficient clearance to vias and other components.

### TYPICAL PERFORMANCE CHARACTERISTICS

$V_{CC} = 3.3\text{ V}$ ,  $V_{EE} = 0.0\text{ V}$ ,  $T_A = 25^\circ\text{C}$ , outputs terminated  $50\ \Omega$  to  $V_{CC} - 2\text{ V}$ , unless otherwise noted.

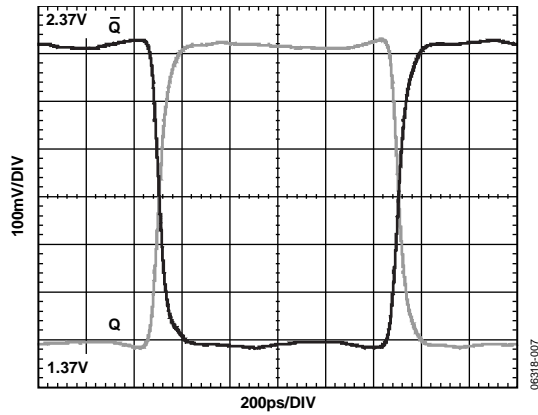

Figure 7. Output Waveform,  $V_{CC} = 3.3\text{ V}$

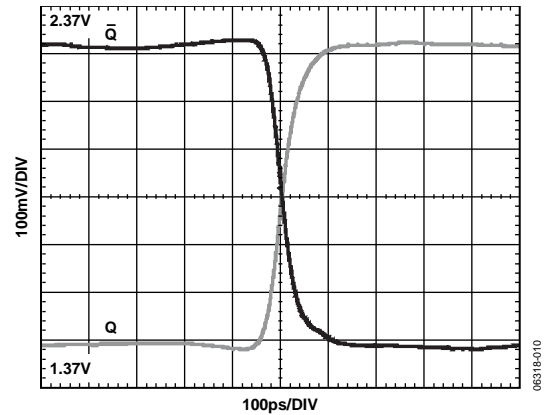

Figure 10. Output Waveform,  $V_{CC} = 3.3\text{ V}$

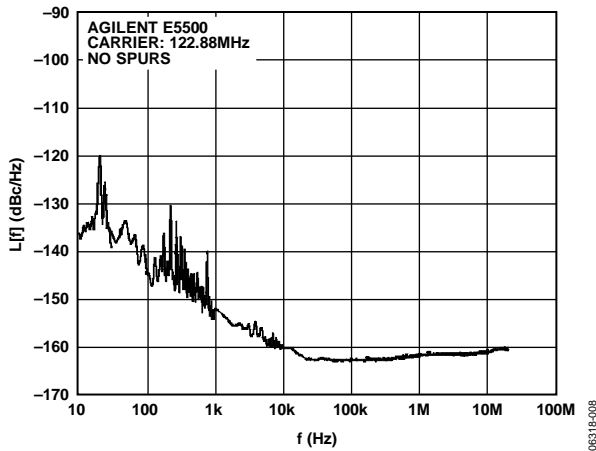

Figure 8. Phase Noise at 122.88 MHz

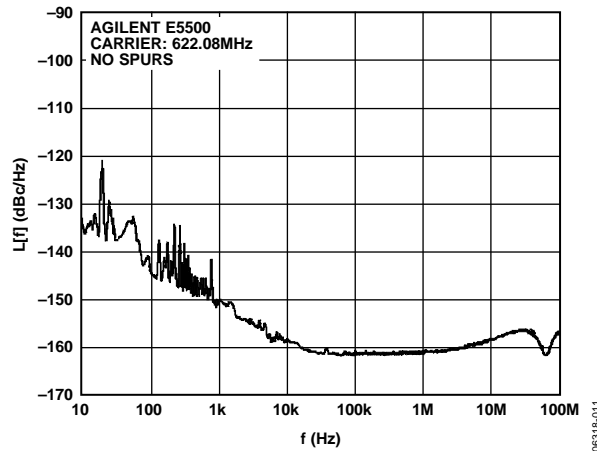

Figure 11. Phase Noise at 622.08 MHz

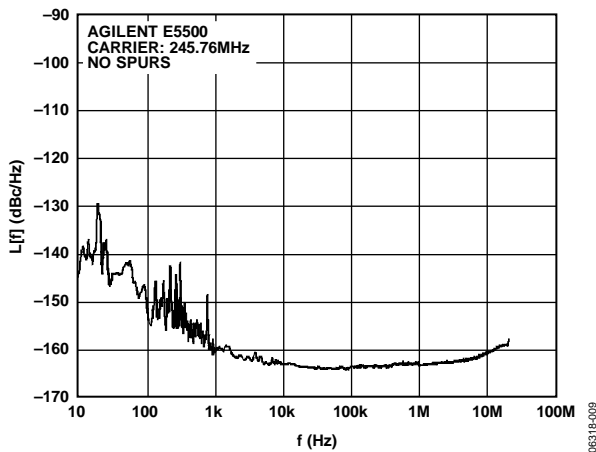

Figure 9. Phase Noise at 245.76 MHz

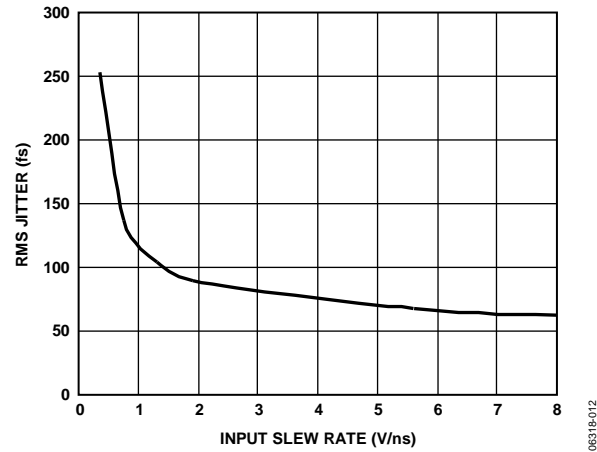

Figure 12. RMS Jitter vs. Input Slew Rate

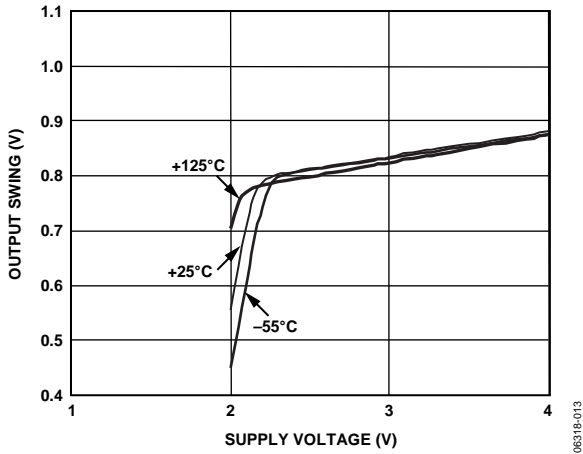

Figure 13.  $V_{OD}$  vs. Power Supply Voltage

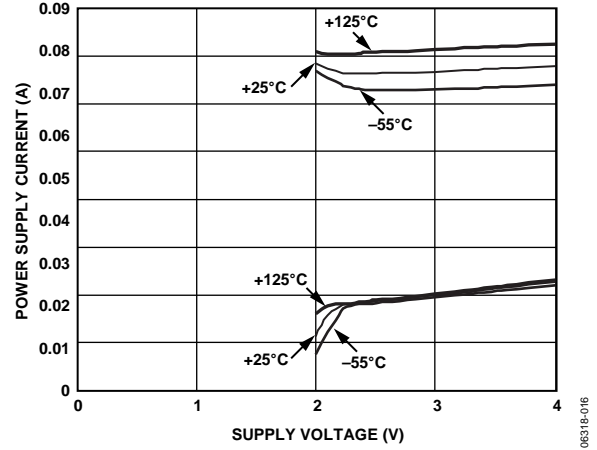

Figure 16. Power Supply Current vs. Supply Voltage, ADCLK925

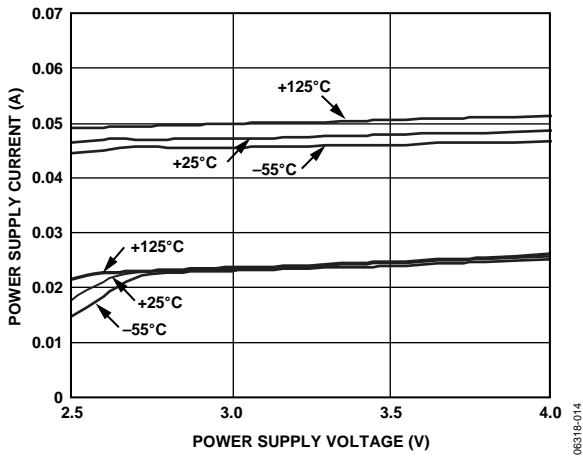

Figure 14. Power Supply Current vs. Power Supply Voltage, ADCLK905

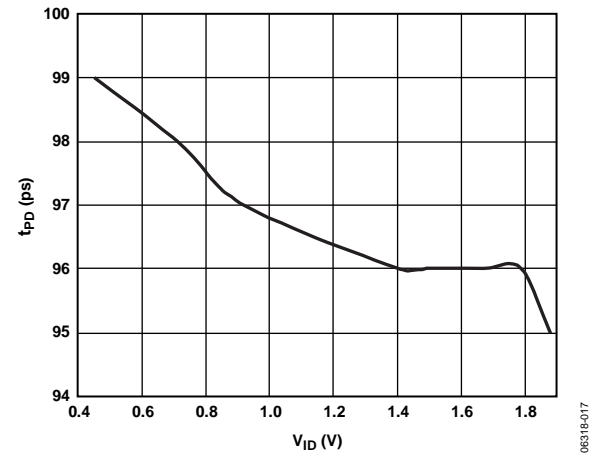

Figure 17. Propagation Delay vs.  $V_{ID}$

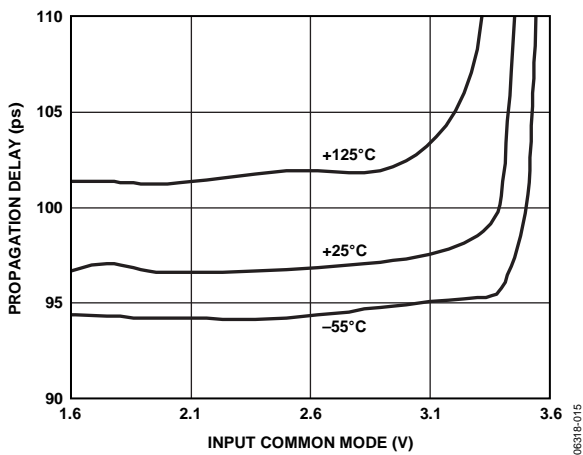

Figure 15. Propagation Delay vs.  $V_{ICM}$ ; Input Swing = 200 mV

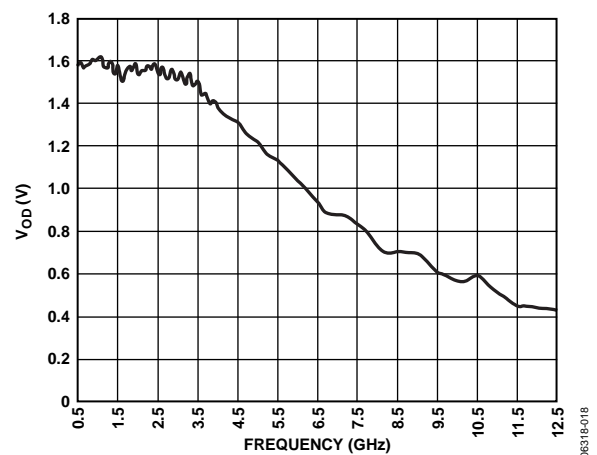

Figure 18. Toggle Rate, Differential Output Swing vs. Frequency

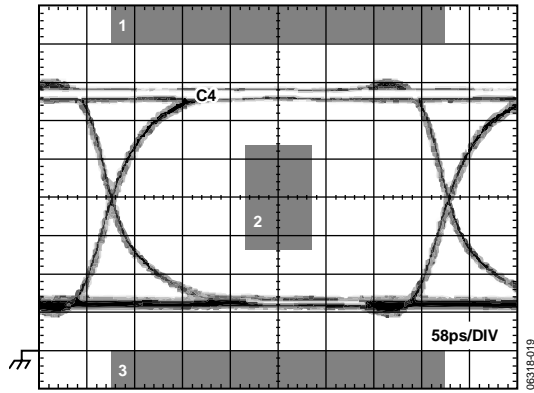

Figure 19. 2.488 Gbps PRBS  $2^{23} - 1$  with OC-48/STM-16 Mask, Measured p-p Jitter 8.1 ps, Source p-p Jitter 3.5 ps

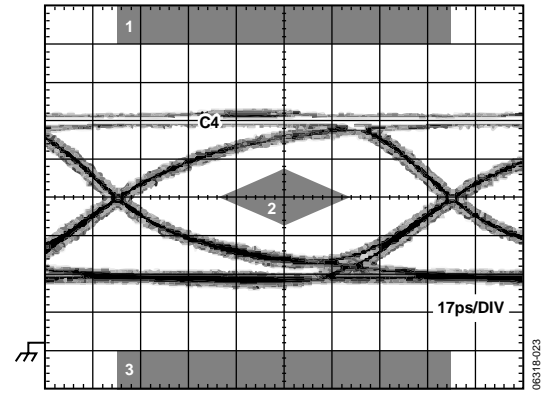

Figure 22. 8.50 Gbps PRBS  $2^{23} - 1$  with FC8500E ABS Beta Rx Mask, Measured p-p Jitter 10.9 ps, Source p-p Jitter 4.4 ps

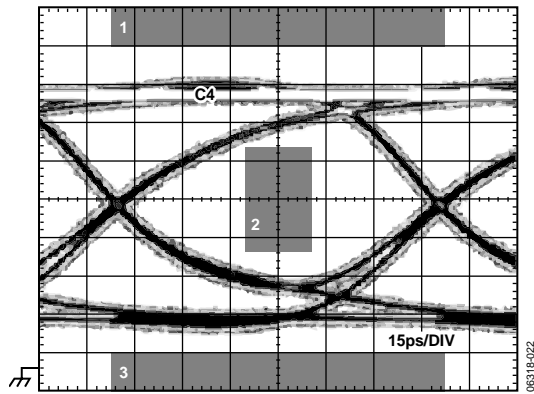

Figure 20. 9.95 Gbps PRBS  $2^{23} - 1$  with OC-193/STM-64 Mask, Measured p-p Jitter 10.5 ps, Source p-p Jitter 6.0 ps

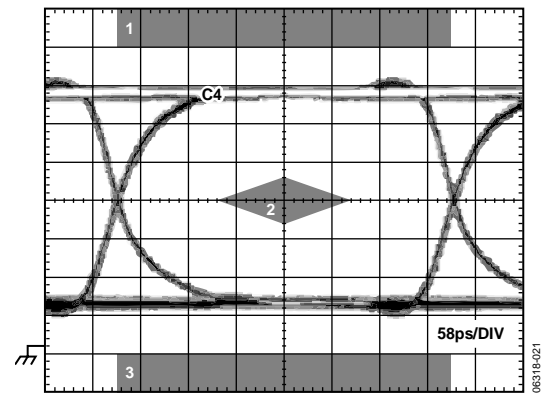

Figure 23. 2.5 Gbps PRBS  $2^{23} - 1$  with PCI Express 2.5 Rx Mask, Measured p-p Jitter 8.1 ps, Source p-p Jitter 3.5 ps

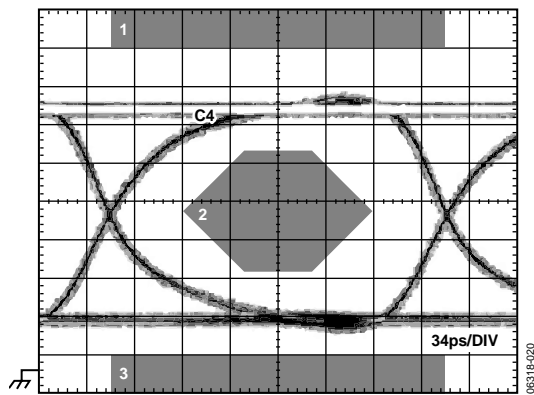

Figure 21. 4.25 Gbps PRBS  $2^{23} - 1$  with FC4250 (Optical) Mask, Measured p-p Jitter 8.2 ps, Source p-p Jitter 3.4 ps

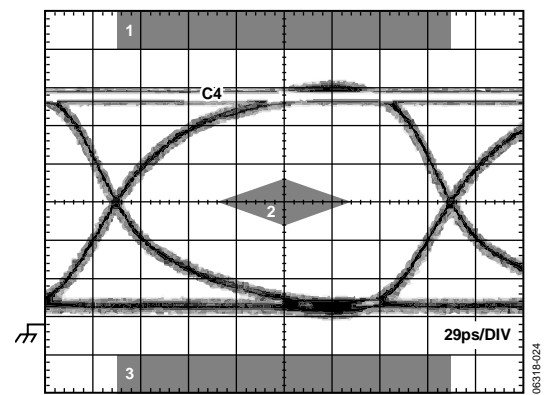

Figure 24. 5.0 Gbps PRBS  $2^{23} - 1$  with PCI Express 5.0 Rx Mask, Measured p-p Jitter 8.7 ps, Source p-p Jitter 3.5 ps

## APPLICATIONS INFORMATION

### POWER/GROUND LAYOUT AND BYPASSING

The ADCLK905/ADCLK907/ADCLK925 buffers are designed for very high speed applications. Consequently, high speed design techniques must be used to achieve the specified performance. It is critically important to use low impedance supply planes for both the negative supply ( $V_{EE}$ ) and the positive supply ( $V_{CC}$ ) planes as part of a multilayer board. Providing the lowest inductance return path for switching currents ensures the best possible performance in the target application.

It is also important to adequately bypass the input and output supplies. A 1  $\mu\text{F}$  electrolytic bypass capacitor should be placed within several inches of each power supply pin to ground. In addition, multiple high quality 0.001  $\mu\text{F}$  bypass capacitors should be placed as close as possible to each of the  $V_{EE}$  and  $V_{CC}$  supply pins and should be connected to the GND plane with redundant vias. High frequency bypass capacitors should be carefully selected for minimum inductance and ESR. Parasitic layout inductance should be strictly avoided to maximize the effectiveness of the bypass at high frequencies.

### OUTPUT STAGES

The specified performance can be achieved only by using proper transmission line terminations. The outputs of the ADCLK905/ADCLK907/ADCLK925 buffers are designed to directly drive 800 mV into 50  $\Omega$  cable or microstrip/stripline transmission lines terminated with 50  $\Omega$  referenced to  $V_{CC} - 2\text{ V}$ . The PECL output stage is shown in Figure 25. The outputs are designed for best transmission line matching. If high speed signals must be routed more than a centimeter, either the microstrip or the stripline technique is required to ensure proper transition times and to prevent excessive output ringing and pulse width-dependent propagation delay dispersion.

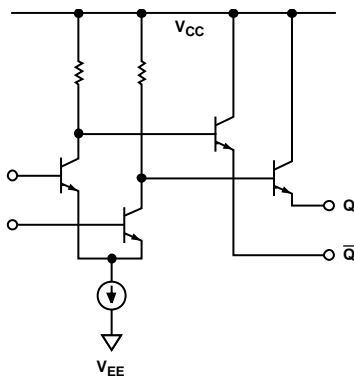

Figure 25. Simplified Schematic Diagram of the ADCLK905/ADCLK907/ADCLK925 PECL Output Stage

### OPTIMIZING HIGH SPEED PERFORMANCE

As with any high speed circuit, proper design and layout techniques are essential to obtaining the specified performance. Stray capacitance, inductance, inductive power and ground impedances, or other layout issues can severely limit performance and cause oscillation. Discontinuities along input and output transmission lines can also severely limit the specified jitter performance by reducing the effective input slew rate.

In a 50  $\Omega$  environment, input and output matching have a significant impact on performance. The buffer provides internal 50  $\Omega$  termination resistors for both D and  $\bar{D}$  inputs. The return side should normally be connected to the reference pin provided. The termination potential should be carefully bypassed, using ceramic capacitors to prevent undesired aberrations on the input signal due to parasitic inductance in the termination return path. If the inputs are directly coupled to a source, care must be taken to ensure the pins are within the rated input differential and common-mode ranges.

If the return is floated, the device exhibits 100  $\Omega$  cross termination, but the source must then control the common-mode voltage and supply the input bias currents.

There are ESD/clamp diodes between the input pins to prevent the application of excessive offsets to the input transistors. ESD diodes are not optimized for best ac performance. When a clamp is desired, it is recommended that appropriate external diodes be used.

### BUFFER RANDOM JITTER

The ADCLK905/ADCLK907/ADCLK925 are specifically designed to minimize added random jitter over a wide input slew rate range. Provided sufficient voltage swing is present, random jitter is affected most by the slew rate of the input signal. Whenever possible, excessively large input signals should be clamped with fast Schottky diodes because attenuators reduce the slew rate. Input signal runs of more than a few centimeters should be over low loss dielectrics or cables with good high frequency characteristics.

TYPICAL APPLICATION CIRCUITS

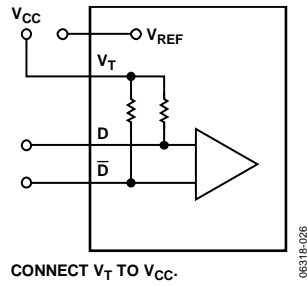

CONNECT  $V_T$  TO  $V_{CC}$ .

06318-026

Figure 26. Interfacing to CML Inputs

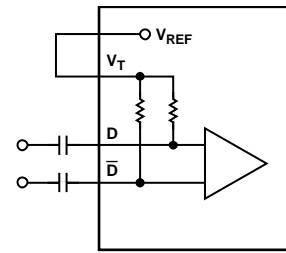

CONNECT  $V_T$  TO  $V_{REF}$ .

NOTES  
1. PLACING A BYPASS CAPACITOR FROM  $V_T$  TO GROUND CAN IMPROVE THE NOISE PERFORMANCE.

06318-029

Figure 28. AC Coupling Differential Signals

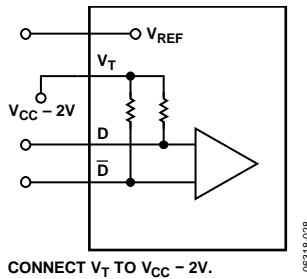

CONNECT  $V_T$  TO  $V_{CC} - 2V$ .

06318-028

Figure 27. Interfacing to PECL

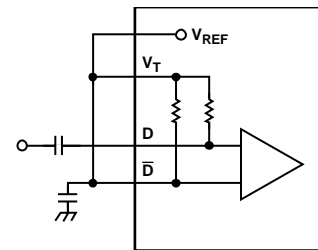

CONNECT  $V_T$ ,  $V_{REF}$ , AND  $\bar{D}$ . PLACE A BYPASS CAPACITOR FROM  $V_T$  TO GROUND. ALTERNATIVELY,  $V_T$ ,  $V_{REF}$ , AND  $D$  CAN BE CONNECTED, GIVING A CLEANER LAYOUT AND A  $180^\circ$  PHASE SHIFT.

06318-030

Figure 29. Interfacing to AC-Coupled Single-Ended Inputs

EVALUATION BOARD SCHEMATIC

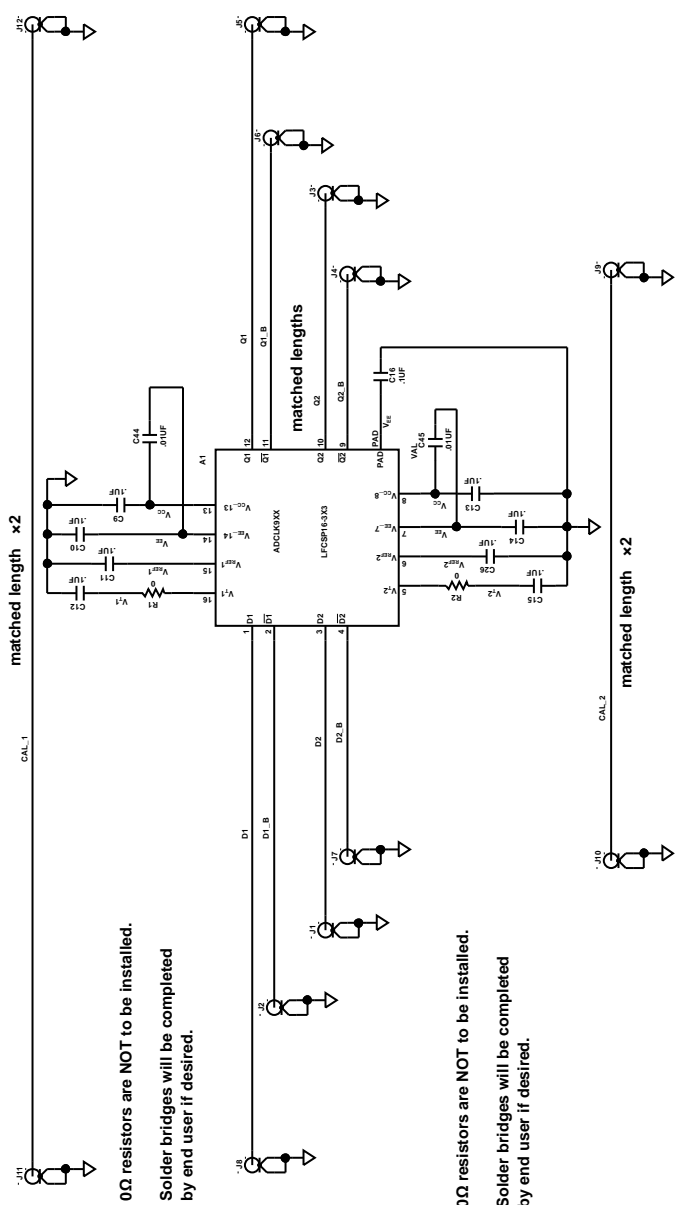
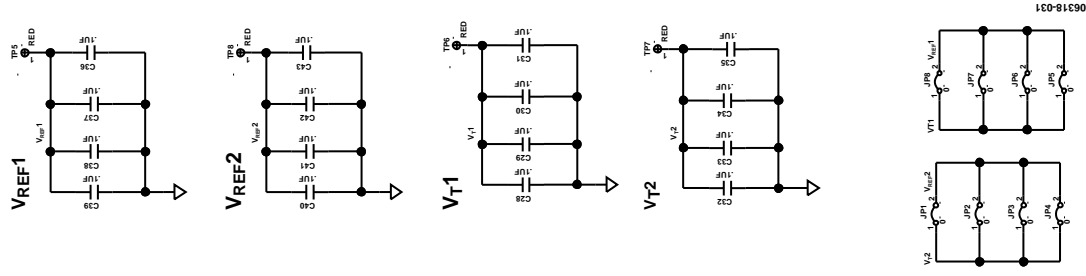

0Ω resistors are NOT to be installed.  
Solder bridges will be completed by end user if desired.

0Ω resistors are NOT to be installed.  
Solder bridges will be completed by end user if desired.

Jumpers are NOT to be installed.  
Solder bridges will be completed by end user if desired.

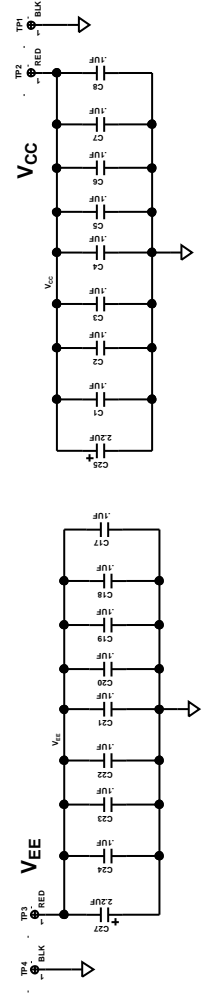
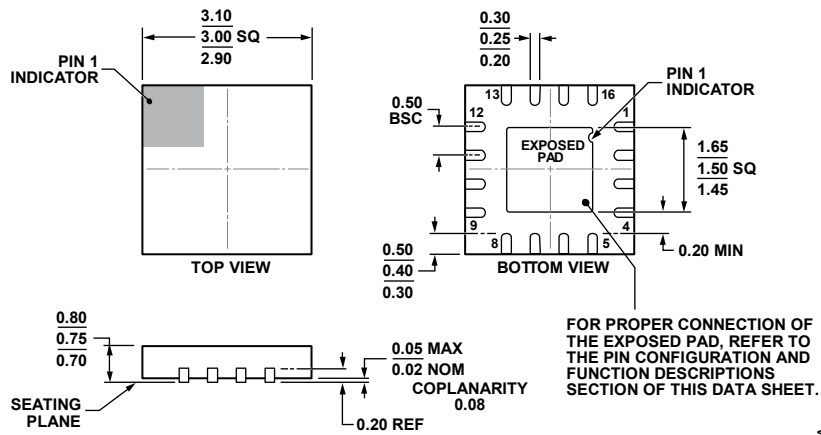

Figure 30. Evaluation Board Schematic

OUTLINE DIMENSIONS



COMPLIANT TO JEDEC STANDARDS MO-220-WEED-6.

Figure 31. 16-Lead Lead Frame Chip Scale Package [LFCSP]  
3 mm × 3 mm Body and 0.75 mm Package Height  
(CP-16-27)

Dimensions shown in millimeters

01-26-2012-A

ORDERING GUIDE

Model <sup>1</sup>	Temperature Range	Package Description	Package Option	Branding
ADCLK905BCPZ-WP	-40°C to +125°C	16-Lead Lead Frame Chip Scale Package [LFCSP]	CP-16-27	Y03
ADCLK905BCPZ-R7	-40°C to +125°C	16-Lead Lead Frame Chip Scale Package [LFCSP]	CP-16-27	Y03
ADCLK905BCPZ-R2	-40°C to +125°C	16-Lead Lead Frame Chip Scale Package [LFCSP]	CP-16-27	Y03
ADCLK907BCPZ-WP	-40°C to +125°C	16-Lead Lead Frame Chip Scale Package [LFCSP]	CP-16-27	Y06
ADCLK907BCPZ-R7	-40°C to +125°C	16-Lead Lead Frame Chip Scale Package [LFCSP]	CP-16-27	Y06
ADCLK907BCPZ-R2	-40°C to +125°C	16-Lead Lead Frame Chip Scale Package [LFCSP]	CP-16-27	Y06
ADCLK925BCPZ-WP	-40°C to +125°C	16-Lead Lead Frame Chip Scale Package [LFCSP]	CP-16-27	Y08
ADCLK925BCPZ-R7	-40°C to +125°C	16-Lead Lead Frame Chip Scale Package [LFCSP]	CP-16-27	Y08
ADCLK925BCPZ-R2	-40°C to +125°C	16-Lead Lead Frame Chip Scale Package [LFCSP]	CP-16-27	Y08
ADCLK905/PCBZ		Evaluation Board		
ADCLK907/PCBZ		Evaluation Board		
ADCLK925/PCBZ		Evaluation Board		

<sup>1</sup> Z = RoHS Compliant Part.



**NOTES**