

阅读申明

- 1.本站收集的数据手册和产品资料都来自互联网，版权归原作者所有。如读者和版权方有任何异议请及时告之，我们将妥善解决。
- 2.本站提供的中文数据手册是英文数据手册的中文翻译，其目的是协助用户阅读，该译文无法自动跟随原稿更新，同时也可能存在翻译上的不当。建议读者以英文原稿为参考以便获得更精准的信息。
- 3.本站提供的产品资料，来自厂商的技术支持或者使用者的心得体会等，其内容可能存在描述上的差异，建议读者做出适当判断。
- 4.如需与我们联系，请发邮件到marketing@iczoom.com，主题请标有“数据手册”字样。

Read Statement

1. The datasheets and other product information on the site are all from network reference or other public materials, and the copyright belongs to the original author and original published source. If readers and copyright owners have any objections, please contact us and we will deal with it in a timely manner.
2. The Chinese datasheets provided on the website is a Chinese translation of the English datasheets. Its purpose is for reader's learning exchange only and do not involve commercial purposes. The translation cannot be automatically updated with the original manuscript, and there may also be improper translations. Readers are advised to use the English manuscript as a reference for more accurate information.
3. All product information provided on the website refer to solutions from manufacturers' technical support or users the contents may have differences in description, and readers are advised to take the original article as the standard.
4. If you have any questions, please contact us at marketing@iczoom.com and mark the subject with "Datasheets" .

Built in VCXO, Spread-Spectrum Clock Generator



BU3087FV

●Description

BU3087FV has built in VCXO that is necessary for the Digital-TV signal reception. Connecting 27MHz crystal oscillator generates clock signals to 74.25MHz for Hi-Vision. BU3087FV has built in Spread-Spectrum function too.

●Features

- 3225 size crystal is usable
- ON / OFF of Spread-Spectrum is selectable
- Four kinds of Modulation-Rate is selectable ($\pm 0.25\%$ / $\pm 0.50\%$ / $\pm 0.75\%$ / $\pm 1.00\%$)
- Triangular Modulation

●Applications

Digital-TV, STB, TV-Tuner

●Key Specifications

- | | |
|-------------------------|--|
| ■ Crystal Pullability | $\pm 105\text{ppm}$ (Typ.) |
| ■ Modulation Frequency | 34.5kHz (Typ.) |
| ■ Cycle-to-Cycle Jitter | 180psec (Typ.) |
| ■ Operating Current | 45mA (Typ.) |
| ■ Operating Temperature | -10°C to $+75^{\circ}\text{C}$ |

●Package

SSOP-B16

(Typ.) (Typ.) (Max.)
5.00mm x 6.40mm x 1.35mm

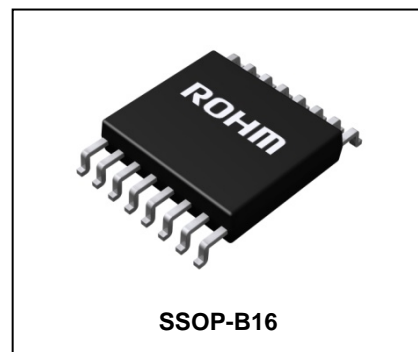

●Typical Application Circuit

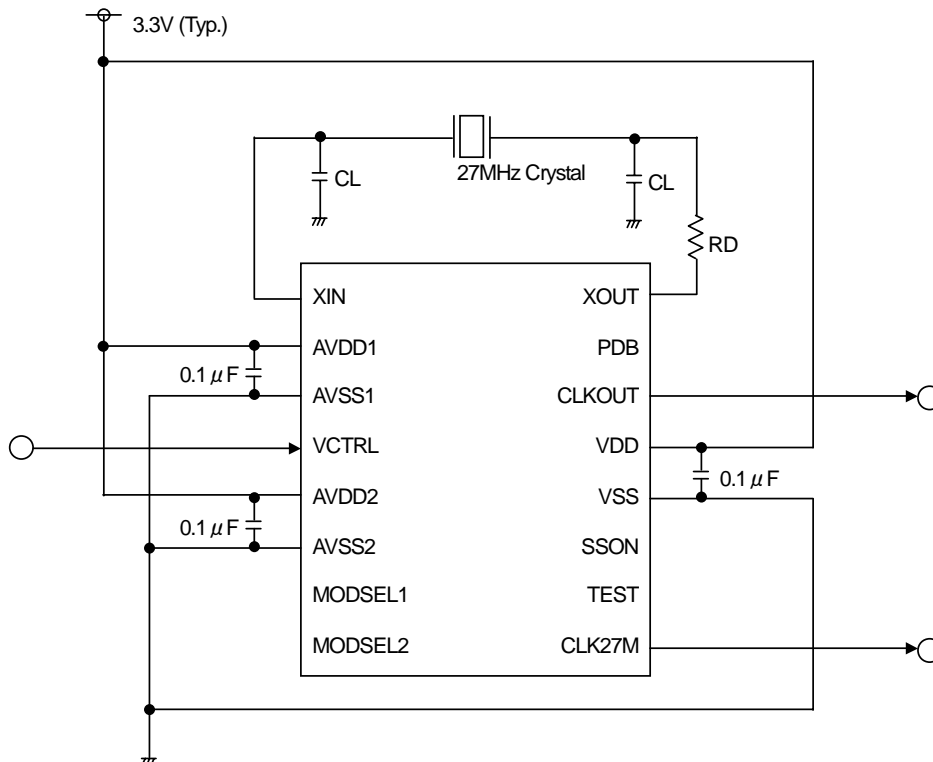

Figure 1. Typical Application Circuit

(Caution) CL and RD in Typical Application Circuit should be optimized as to using crystal and board condition.

●Block Diagram

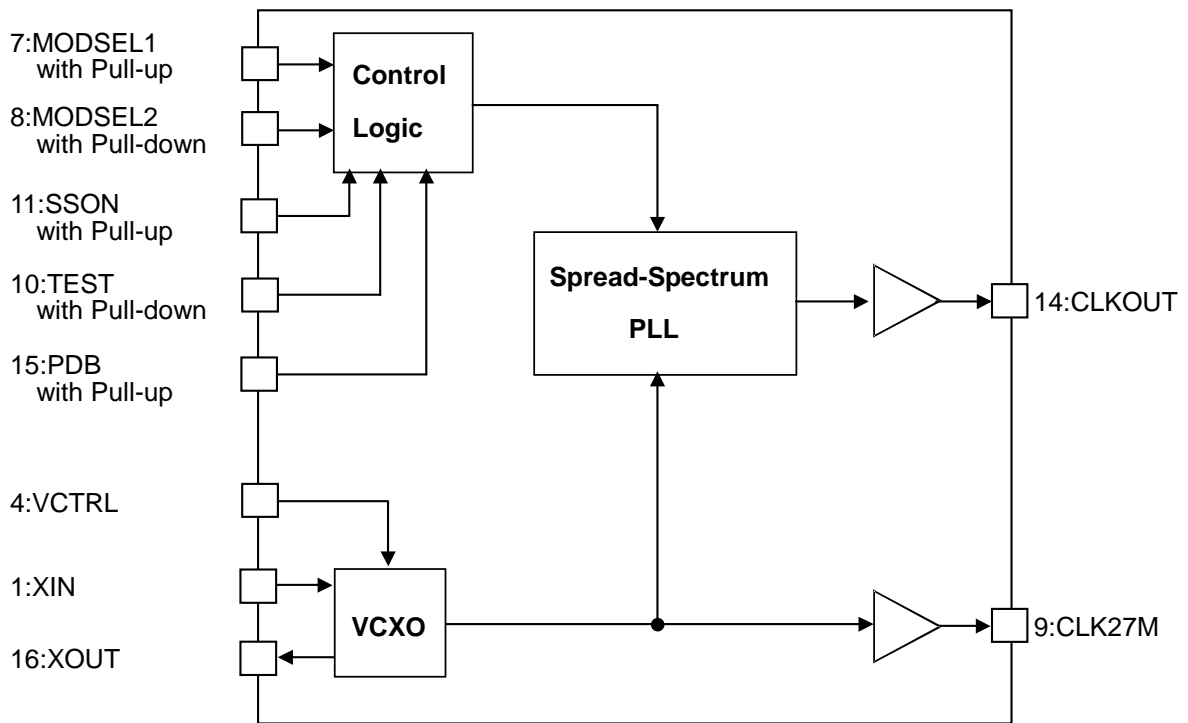

Figure 2. Block Diagram

●Pin Configuration

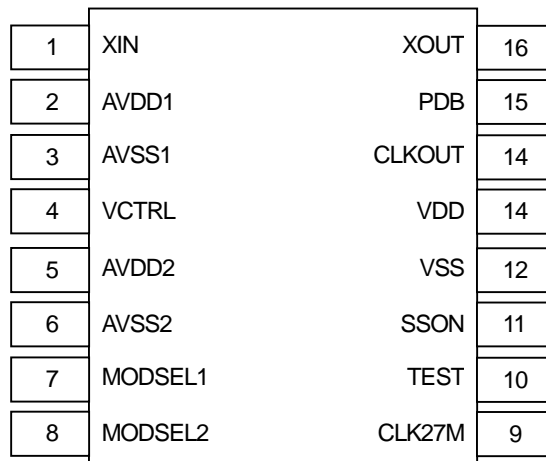

Figure 3. Pin Configuration (TOP VIEW)

● Pin Function

PIN No.	PIN Name	Function
1	XIN	Crystal Input terminal
2	AVDD1	Power supply for VCXO
3	AVSS1	GND for VCXO
4	VCTRL	VCXO control input terminal
5	AVDD2	Power supply for PLL-Analog
6	AVSS2	GND for PLL-Analog
7	MODSEL1	Spread-Spectrum Modulation control terminal (Refer to Table of Spread-Spectrum Modulation) with pull-up
8	MODSEL2	Spread-Spectrum Modulation control terminal (Refer to Table of Spread-Spectrum Modulation) with pull-down
9	CLK27M	27.000000MHz Output
10	TEST	Test terminal, with pull-down
11	SSON	Spread-Spectrum ON/OFF choice (H : ON、L : OFF) , with pull-up
12	VSS	GND for PLL-Digital
13	VDD	Power supply for PLL-Digital
14	CLKOUT	74.250000MHz Output
15	PDB	Power-down control terminal, with pull-up
16	XOUT	Crystal Output terminal

● Table of Spread-Spectrum Modulation (1Pin_XIN input frequency =27.000000MHz)

In the case of 11Pin_SSON=H, outputs it according to the following table.

MODSEL2	MODSEL1	CLKOUT
L	L	74.250000MHz \pm 0.25% Modulation
L	H	74.250000MHz \pm 0.50% Modulation
H	L	74.250000MHz \pm 0.75% Modulation
H	H	74.250000MHz \pm 1.00% Modulation

In the case of 11Pin_SSON=L, outputs unmodulated clock.

●Absolute Maximum Ratings (Ta=25°C)

Parameter	Symbol	Ratings	Unit
Supply voltage	VDD	-0.3 to 4.0	V
Input Voltage	VIN	-0.3 to VDD+0.3	V
Storage Temperature range	Tstg	-55 to 125	°C
Power dissipation	PD	690 ^{※1}	mW

^{※1} A measure value at mounting on 70mm x 70mm x 1.6mm glass epoxy substrate.
In the case of exceeding Ta=25°C, 6.9mW should be reduced per 1°C.

●Recommended Operating Ratings

Parameter	Symbol	Ratings	Unit
Supply voltage	VDD	3.135 to 3.465	V
Input "H" Voltage	VIH	0.8VDD to VDD	V
Input "L" Voltage	VIL	0.0 to 0.2VDD	V
Operating Temperature	topr	-10 to 75	°C
Frequency Control Voltage	Vc	0.0 to VDD	V
Output load	CL	15 (MAX)	pF

^{※1} In case of Output load exceeds previous value , consideration should be adapted Rise Time and Fall Time for condition of use.

●Electrical Characteristics

DC Characteristics

(VDD=3.3V, Ta=25°C, Crystal Frequency=27.000000MHz, at No Load, unless otherwise specified)

Parameter	Symbol	Limit			Unit	Conditions
		Min.	Typ.	Max.		
Output H voltage	VOH	VDD-0.4	—	—	V	IOH=4.0mA
Output L voltage	VOL	—	—	0.4	V	IOL=4.0mA
Operating Circuit current	IDD	—	45.0	58.0	mA	Output no load, ±0.50% Modulation
Input H current 1	IupH	-1.5	—	1.5	µA	PDB, SSON, MODSEL1 Terminal VIH=VDD
Input H current 2	IdnH	35.0	70.0	105.5	µA	MODSEL2, TEST Terminal, VIH=VDD
Input H current 3	IdirH	-1.5	—	1.5	µA	VCTRL Terminal, VIH=VDD
Input L current 1	IupL	-105.5	-70.0	-35.0	µA	PDB, SSON, MODSEL1 Terminal VIL=0.0V
Input L current 2	IdnL	-1.5	—	1.5	µA	MODSEL2, TEST Terminal, VIL=0.0V
Input L current 3	IdirL	-1.5	—	1.5	µA	VCTRL Terminal, VIL=0.0V
CLKOUT	CLKOUT	74.248144	74.250000	74.251856	MHz	VCTRL=1/2VDD
Crystal Pullability	fp	±80	±105	±130	ppm	0 ≤ VCTRL ≤ VDD ※1
Spread-Spectrum Modulation Frequency	Fmod	32.5	34.5	36.5	kHz	Triangular Modulation, Independently of Modulation Rate

※1 This is a guarantee with only IC. It is finished with confirmation to operate with Crystal (DSX321G · 8pF load) made in DAISHINKU CORP.

AC Characteristics

(VDD=3.3V, Ta=25°C, Crystal Frequency=27.000000MHz, Output load=15pF, unless otherwise specified)

Following the table cannot test directly on characteristic when shipment, so it is a design guarantee.

Parameter	Symbol	Limit			Unit	Conditions
		Min.	Typ.	Max.		
Duty	Duty	45	50	55	%	Measured at 1/2VDD
Jitter 1 σ	JsSD	—	35	—	psec	Period Jitter 1 σ ※2, in Spread-Spectrum OFF
Jitter P-P	JsABS	—	180	—	psec	Period Jitter MIN-MAX value ※2, in Spread-Spectrum OFF
Jitter Cycle-to-Cycle	JsCyCy	—	180	—	psec	Cycle-to-Cycle Jitter, In ±0.50% Modulation
Rise Time	Tr	—	1.2	—	nsec	Time between 0.2VDD and 0.8VDD
Fall Time	Tf	—	0.7	—	nsec	Time between 0.8VDD and 0.2VDD
Lock Up Time	Tlock	—	—	1	msec	※3

※2 Jitter means center value when using Japan Tektronix : TDS7104 Digital Phosphor Oscilloscope.

※3 Time between voltage supply leads to 3.135V and output clock gets stable.

●Spread-Spectrum Modulation Waveform

Modulation Waveform is triangular. Modulation Rate is selectable among ±0.25%/±0.50%/±0.75%/±1.00%. In addition, Modulation Frequency is 34.5kHz without depending on Modulation Rate.

(Figure 4 shows ±0.50% Modulation Waveform.)

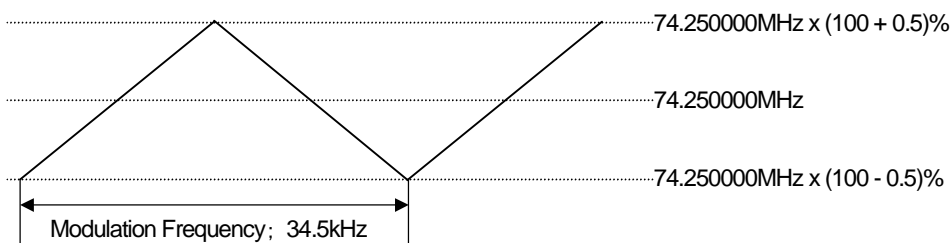
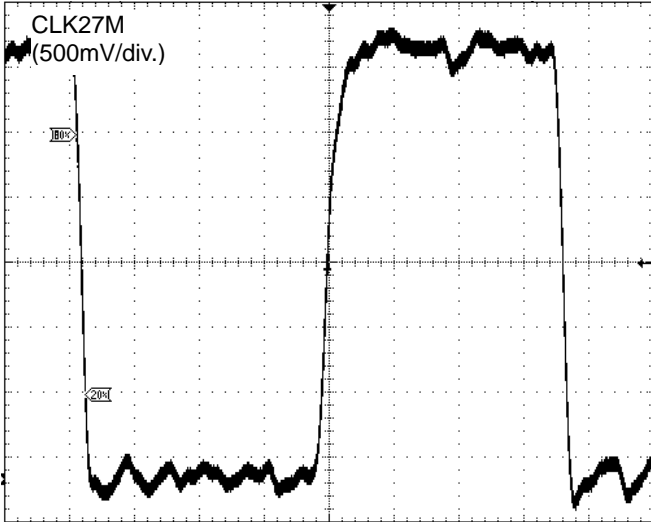
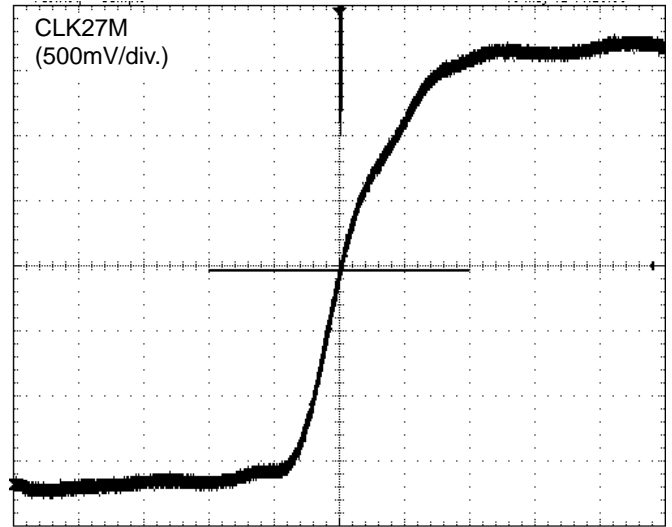

Figure 4. Spread-Spectrum Modulation Waveform

● Typical Wave Forms (VDD=3.3v, Ta=25°C, Spread-Spectrum OFF setting)



TIME (5nsec/div.)
Figure 5. CLK27M Output Waveform



TIME (1nsec/div.)
Figure 6. CLK27M Period-Jitter

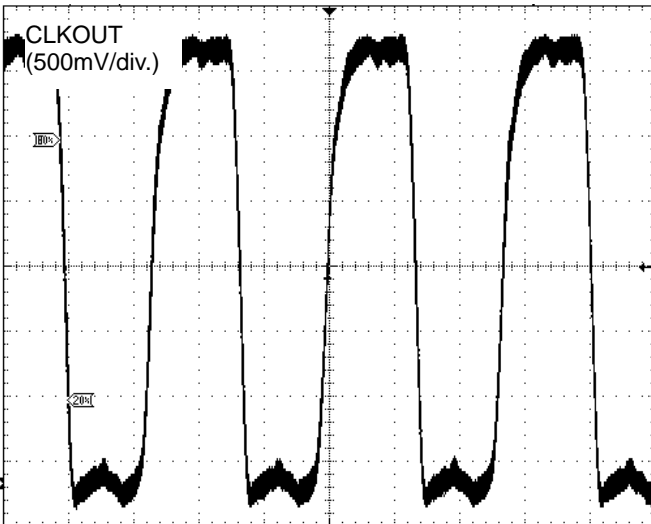

TIME (5nsec/div.)
Figure 7. CLKOUT Output Waveform

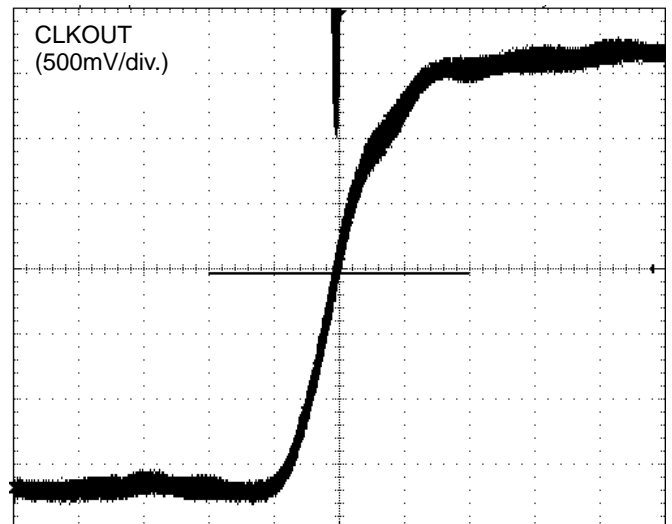

TIME (1nsec/div.)
Figure 8. CLKOUT Period-Jitter

● Typical Performance Curves (Spread-Spectrum OFF setting, Output load=15pF)

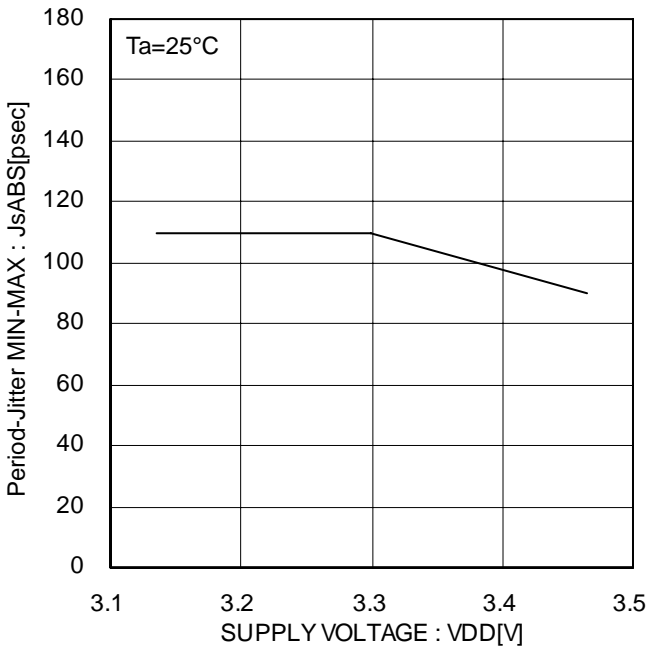

Figure 9. CLK27M Period-Jitter MIN-MAX

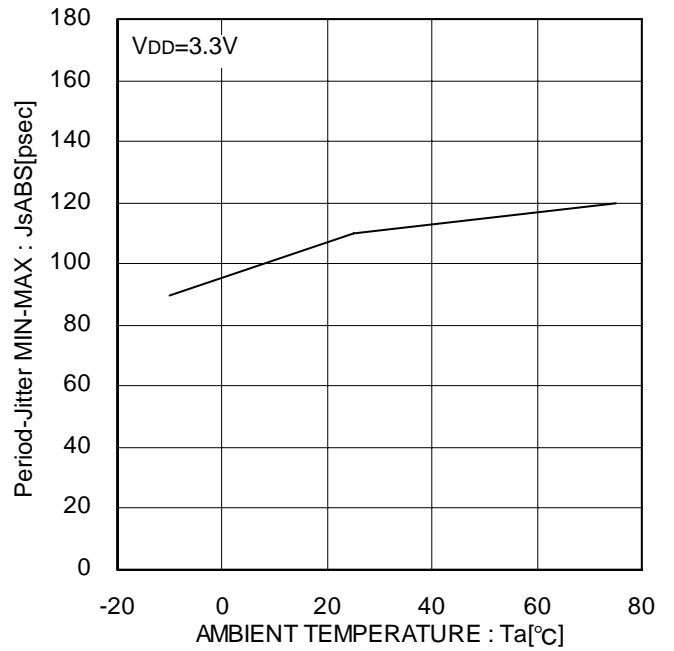

Figure 10. CLK27M Period-Jitter MIN-MAX

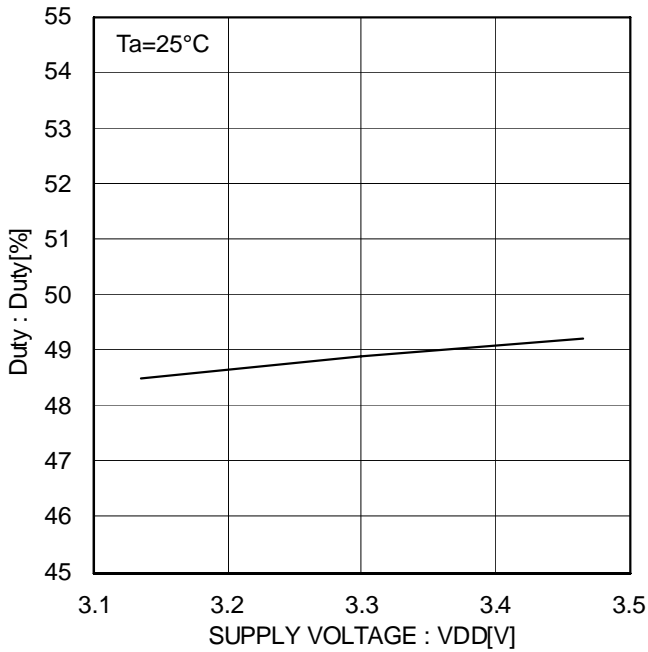

Figure 11. CLK27M Duty

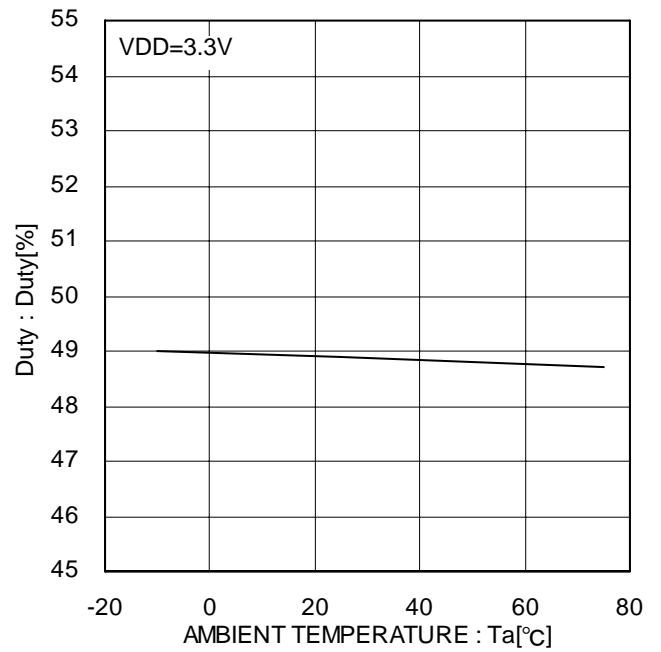

Figure 12. CLK27M Duty

● Typical Performance Curves (Spread-Spectrum OFF setting, Output load=15pF)

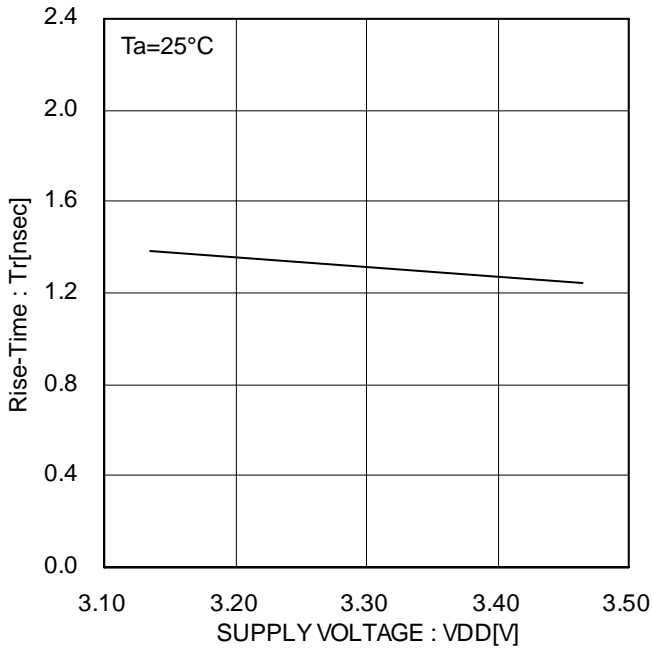

Figure 13. CLK27M Rise-Time

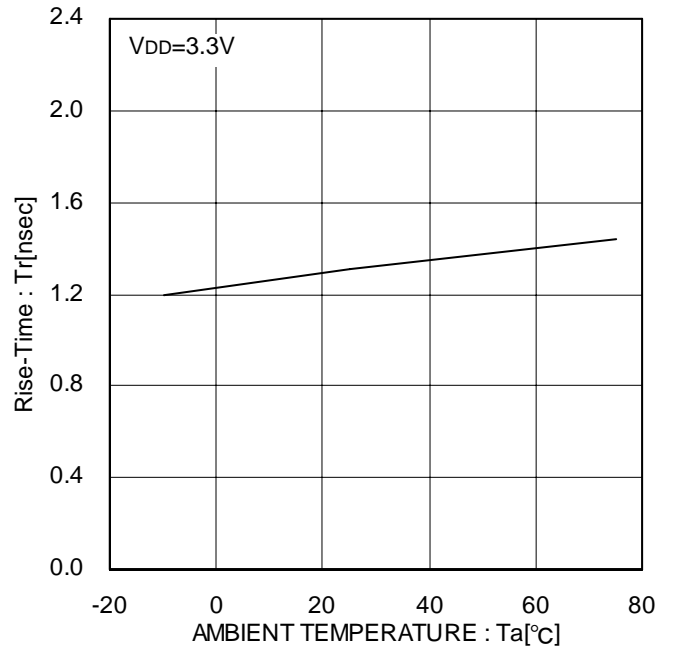

Figure 14. CLK27M Rise-Time

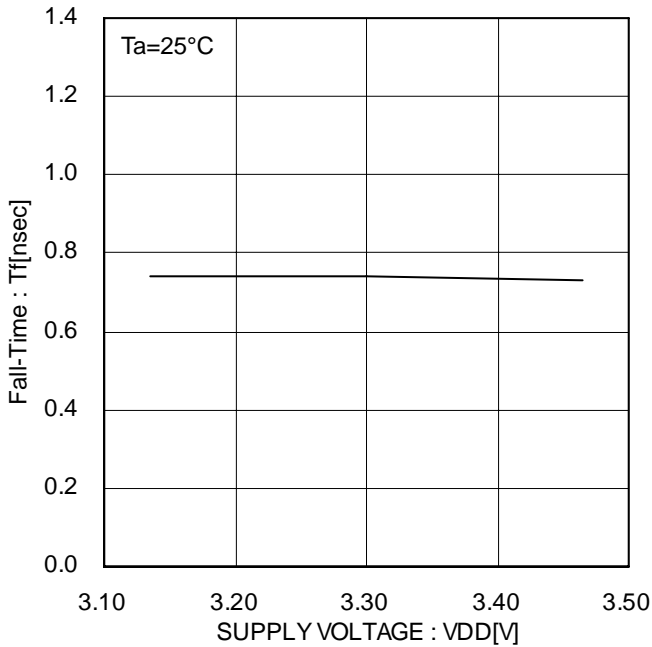

Figure 15. CLK27M Fall-Time

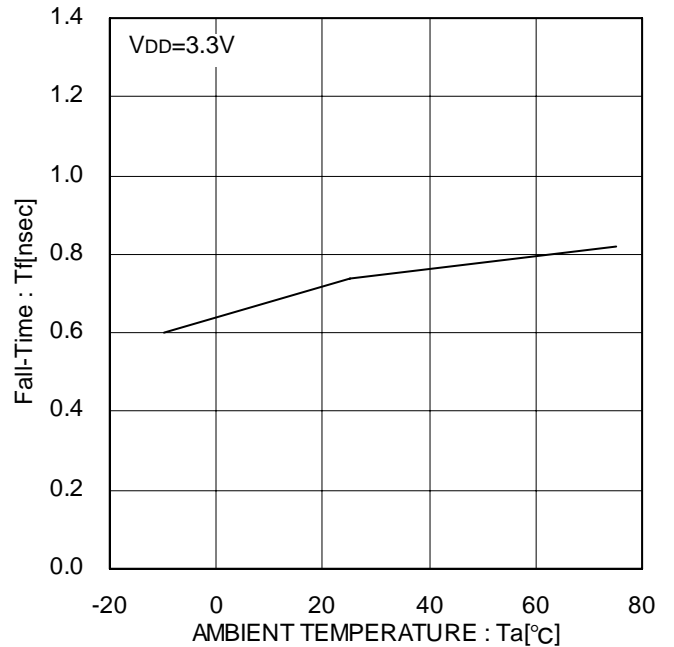

Figure 16. CLK27M Fall-Time

● Typical Performance Curves (Spread-Spectrum OFF setting, Output load=15pF)

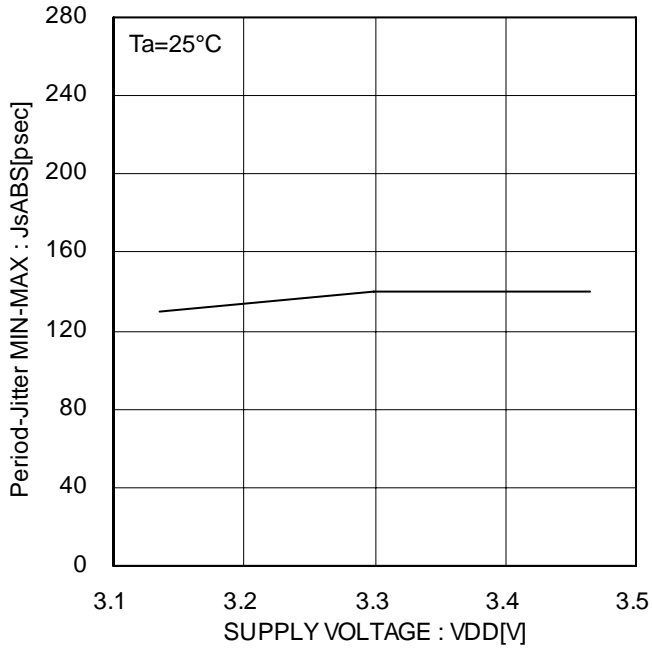

Figure 17. CLKOUT Period-Jitter MIN-MAX

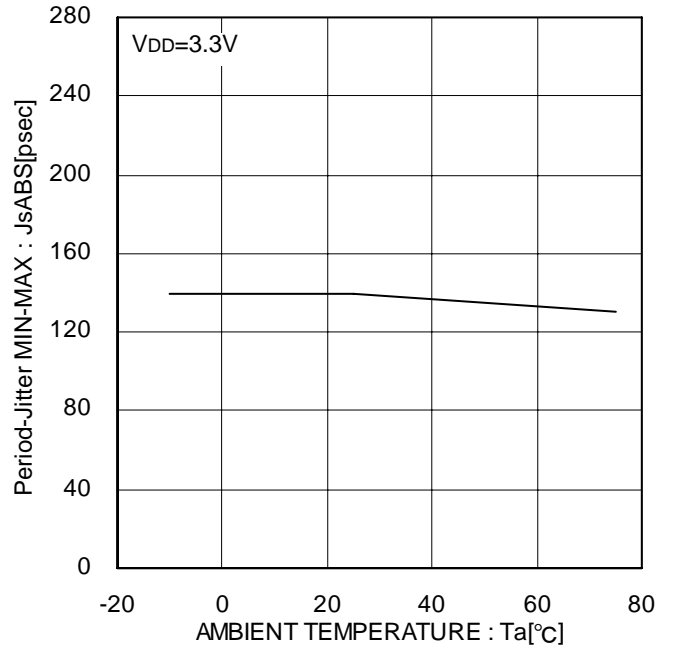

Figure 18. CLKOUT Period-Jitter MIN-MAX

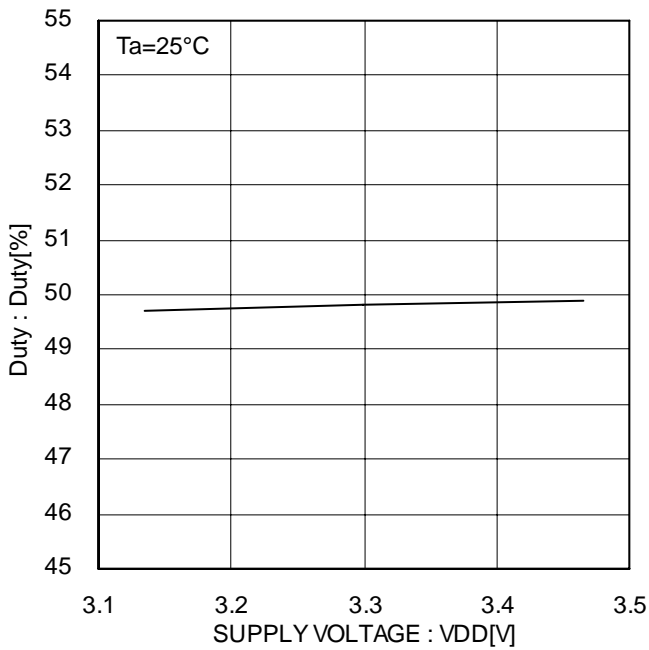

Figure 19. CLKOUT Duty

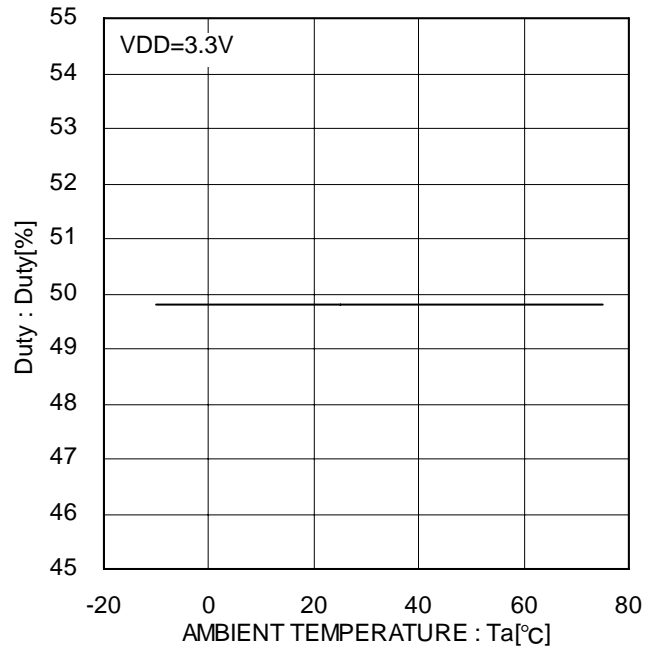

Figure 20. CLKOUT Duty

● Typical Performance Curves (Spread-Spectrum OFF setting, Output load=15pF)

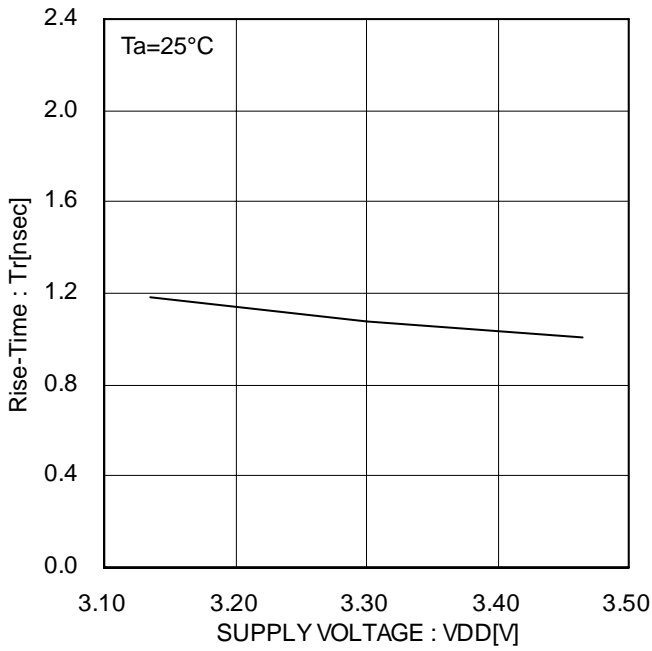

Figure 21. CLKOUT Rise-Time

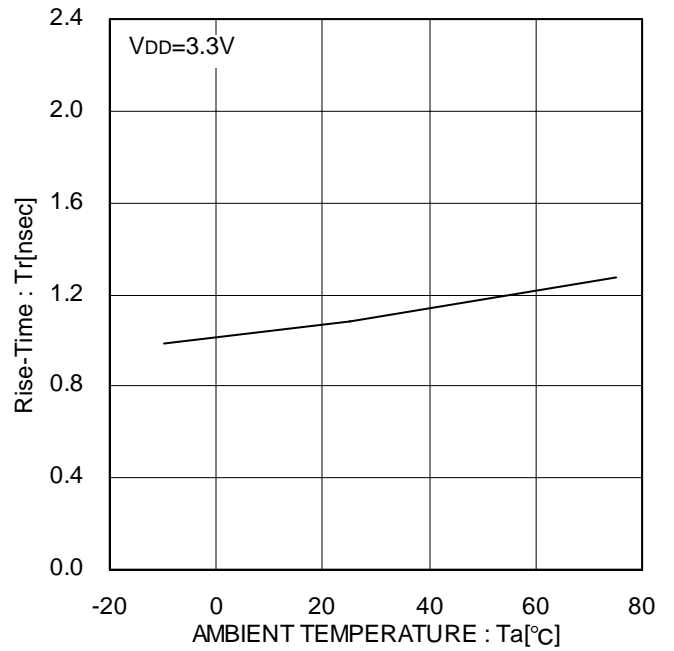

Figure 22. CLKOUT Rise-Time

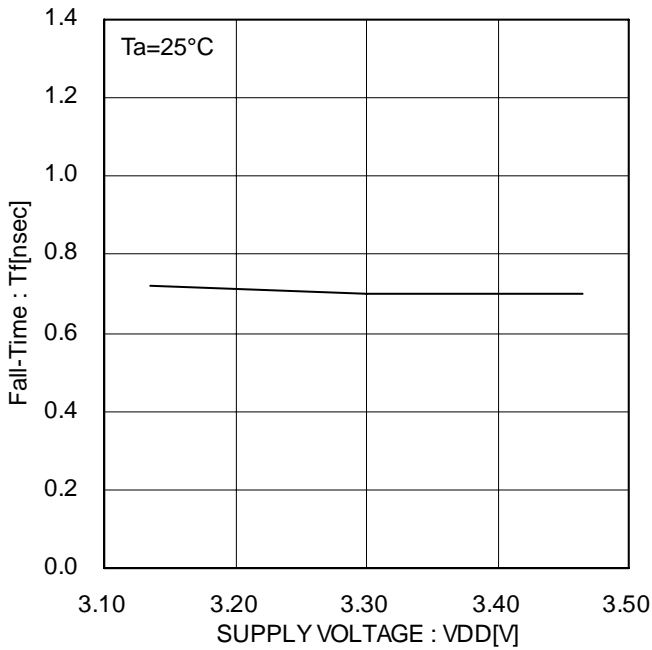

Figure 23. CLKOUT Fall-Time

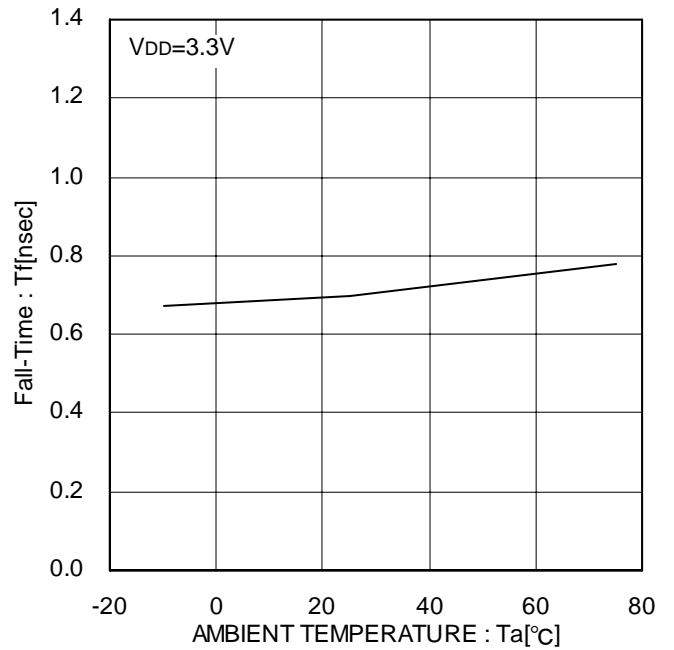
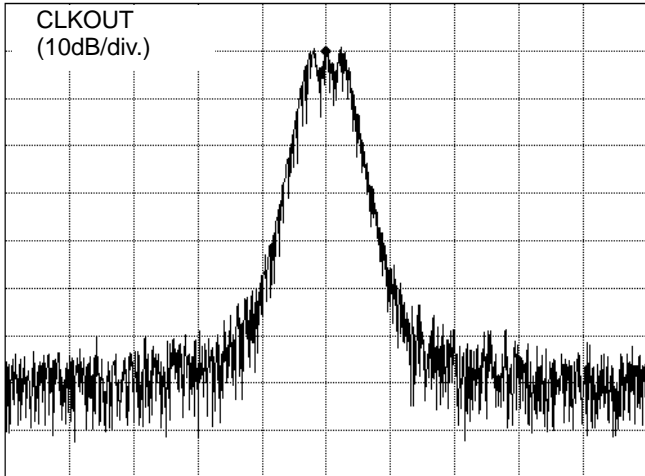
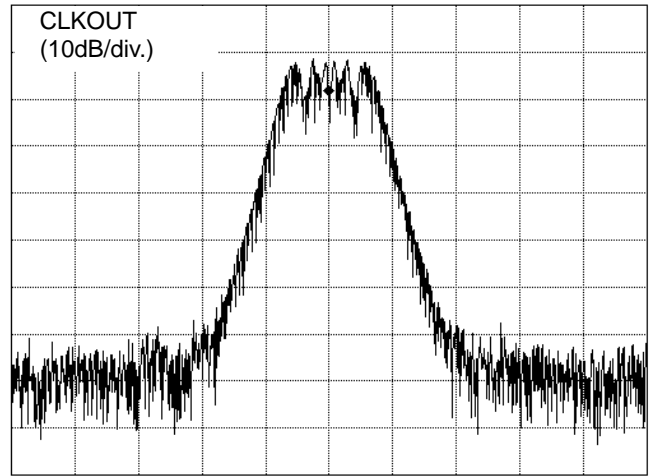

Figure 24. CLKOUT Fall-Time

●Typical Wave Forms (VDD=3.3v, Ta=25°C, Spread-Spectrum ON setting)



FREQUENCY (500kHz/div.)
Figure 25. CLKOUT±0.25% Modulation Spectrum



FREQUENCY (500kHz/div.)
Figure 26. CLKOUT±0.50% Modulation Spectrum

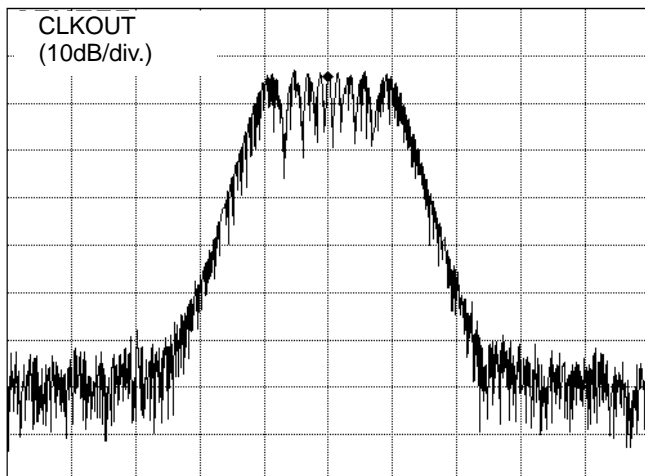

FREQUENCY (500kHz/div.)
Figure 27. CLKOUT±0.75% Modulation Spectrum

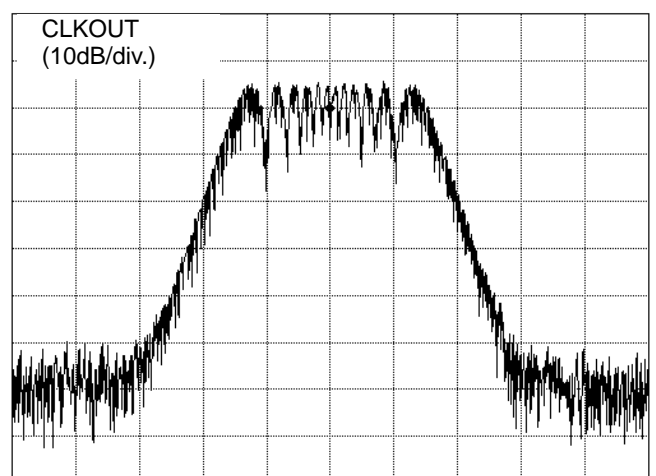

FREQUENCY (500kHz/div.)
Figure 28. CLKOUT±1.00% Modulation Spectrum

●Typical Wave Forms (VDD=3.3v, Ta=25°C, Spread-Spectrum ON setting)

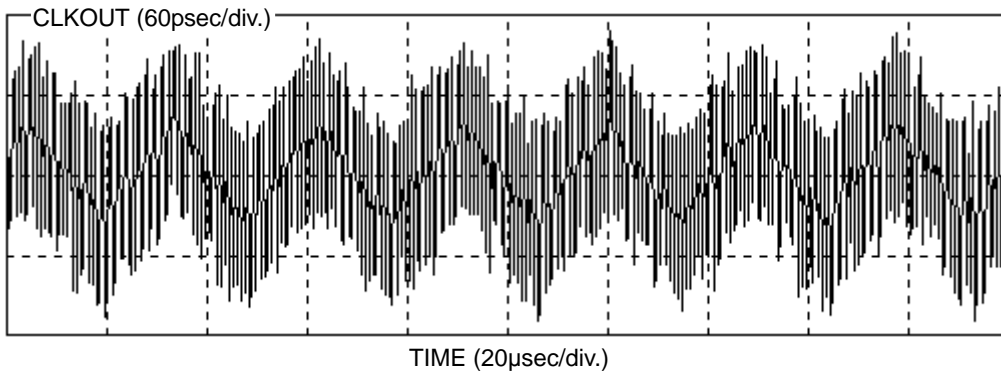

Figure 29. CLKOUT±0.25% Modulation Waveform

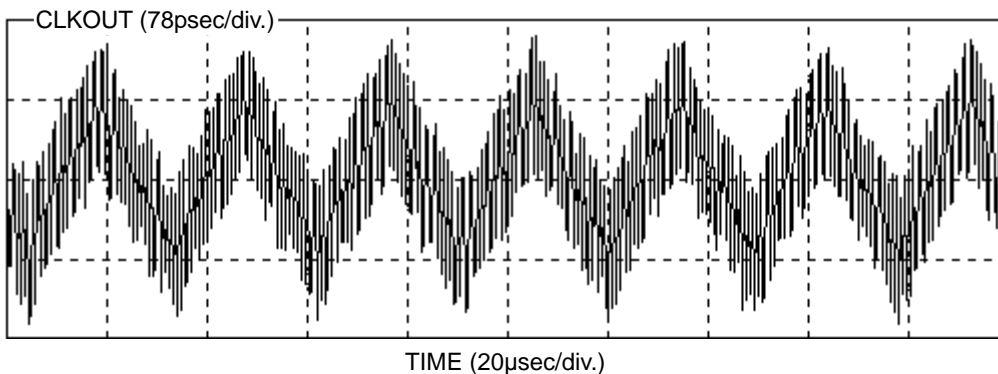

Figure 30. CLKOUT±0.50% Modulation Waveform

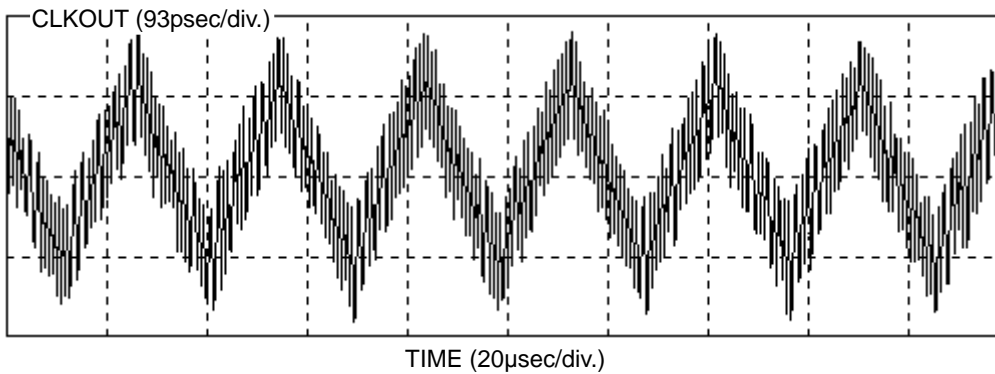

Figure 31. CLKOUT±0.75% Modulation Waveform

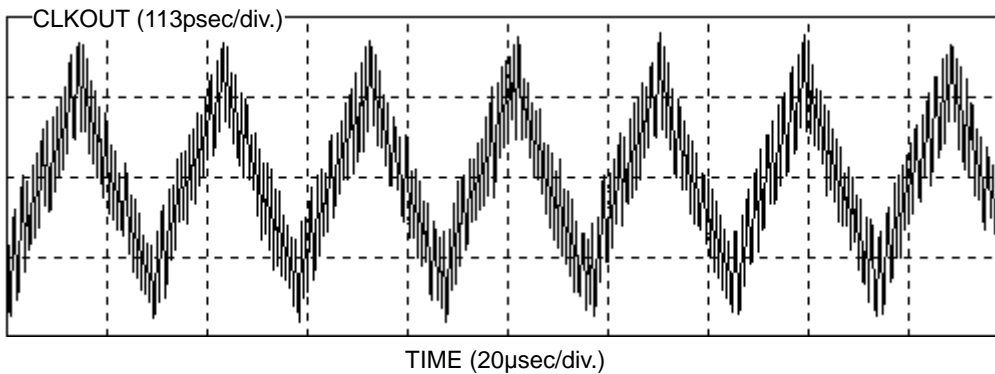

Figure 32. CLKOUT±1.00% Modulation Waveform

● Typical Performance Curves (Spread-Spectrum ON setting, Output load=15pF)

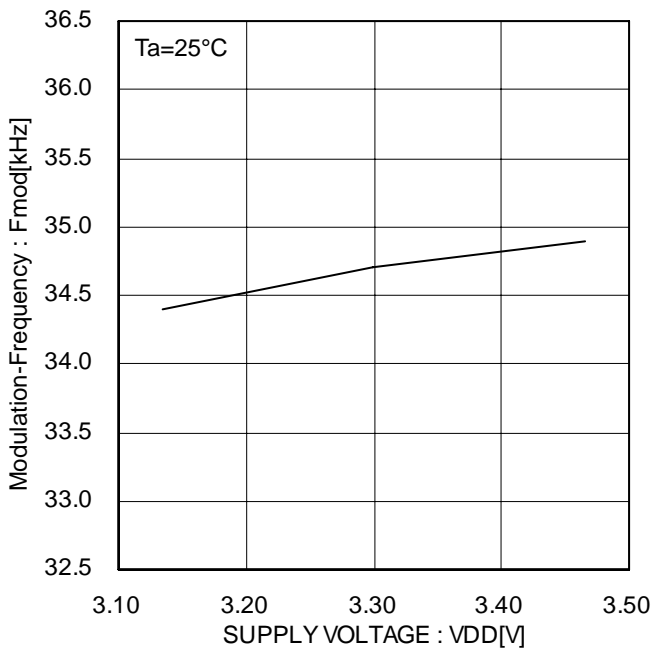

Figure 33. CLKOUT ±0.50% Modulation Frequency

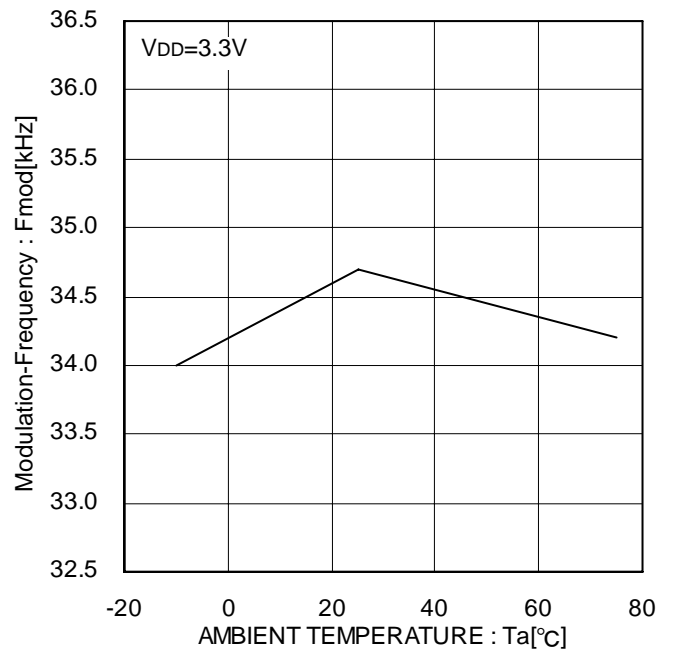

Figure 34. CLKOUT ±0.50% Modulation Frequency

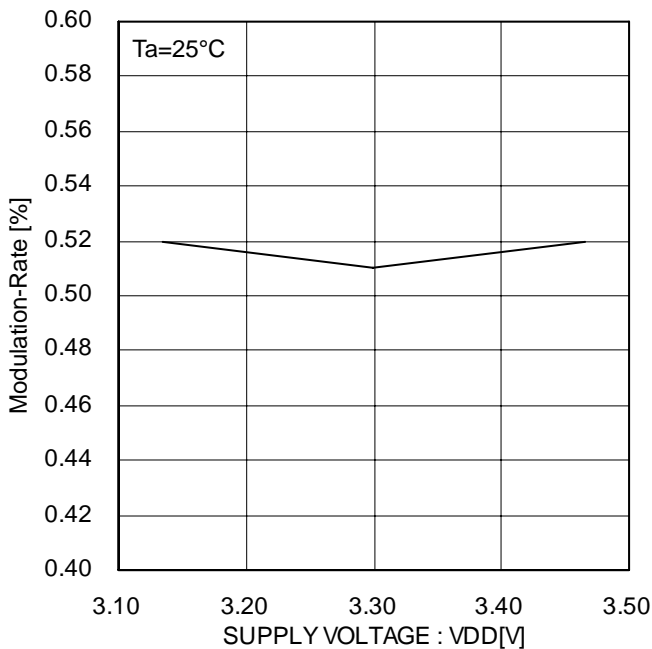

Figure 35. CLKOUT ±0.50% Modulation Rate

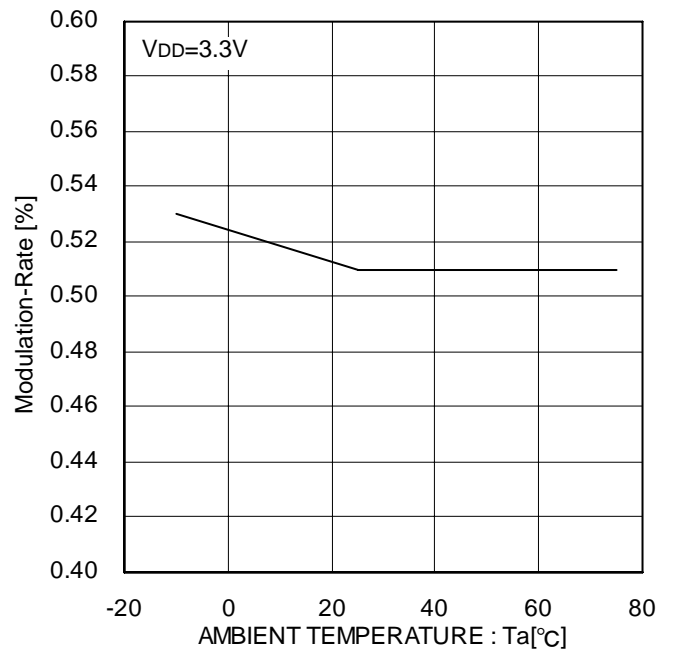

Figure 36. CLKOUT ±0.50% Modulation Rate

Modulation Frequency has a same characteristic despite a Modulation control.
 Modulation Rate has a same trend despite a control.

● Typical Performance Curves (Spread-Spectrum ON setting, Output load=15pF)

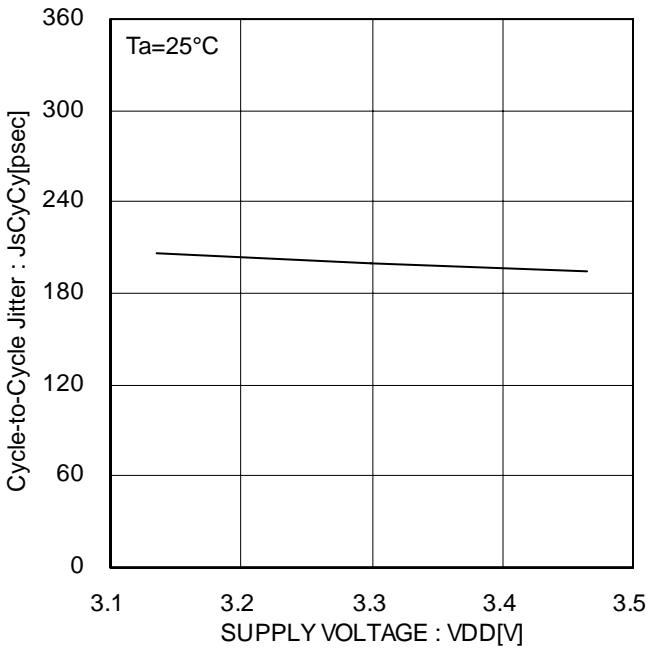

Figure 37. CLKOUT ±0.25% Modulation Cycle-to-Cycle Jitter

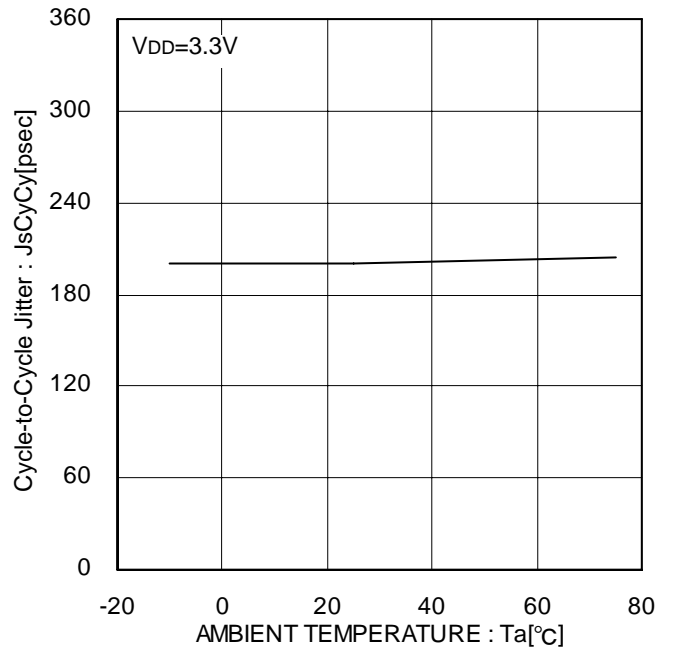

Figure 38. CLKOUT ±0.25% Modulation Cycle-to-Cycle Jitter

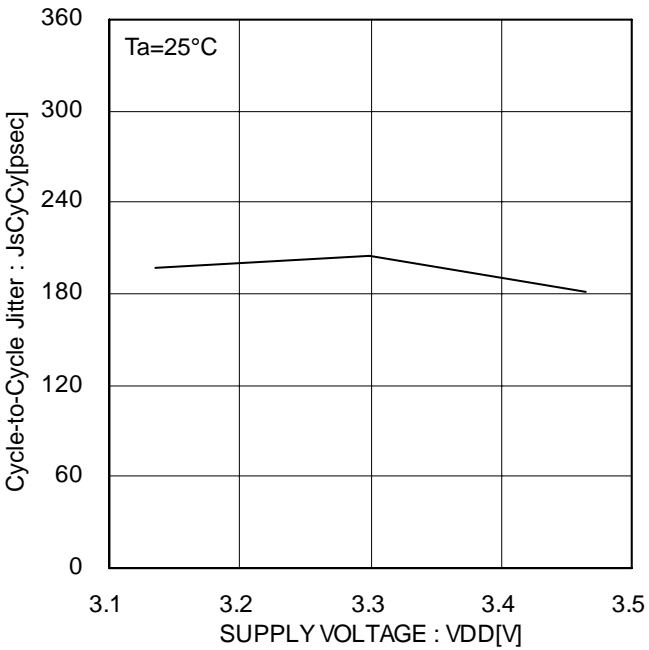

Figure 39. CLKOUT ±0.50% Modulation Cycle-to-Cycle Jitter

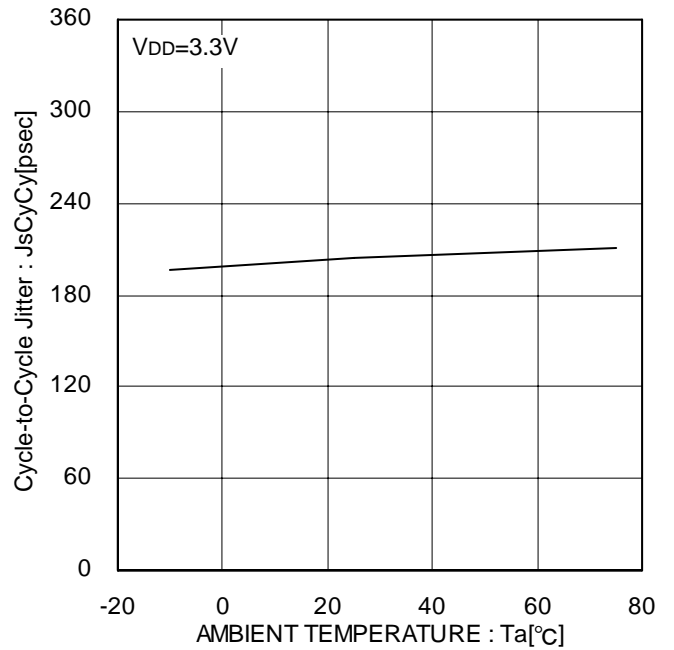

Figure 40. CLKOUT ±0.50% Modulation Cycle-to-Cycle Jitter

● Typical Performance Curves (Spread-Spectrum ON setting, Output load=15pF)

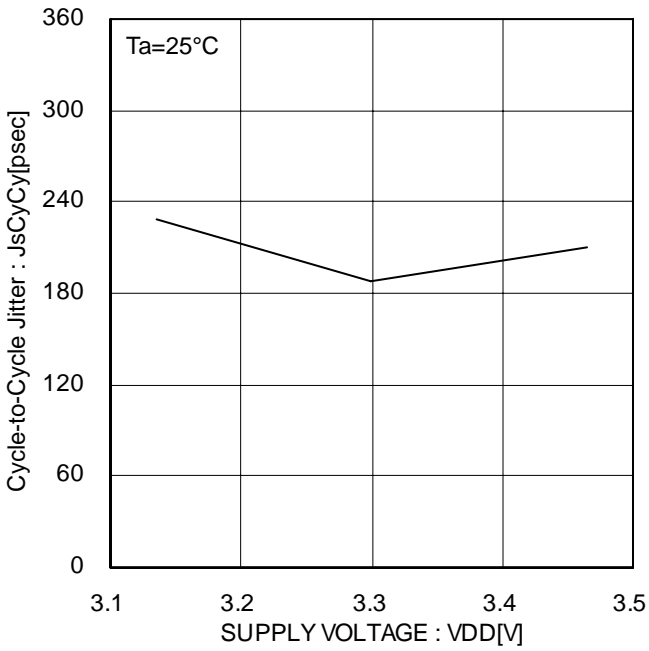

Figure 41. CLKOUT ±0.75% Modulation Cycle-to-Cycle Jitter

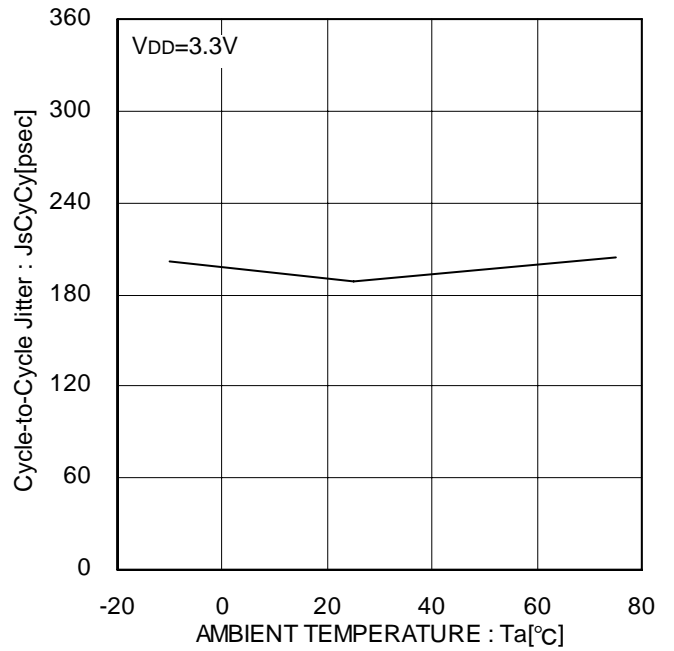

Figure 42. CLKOUT ±0.75% Modulation Cycle-to-Cycle Jitter

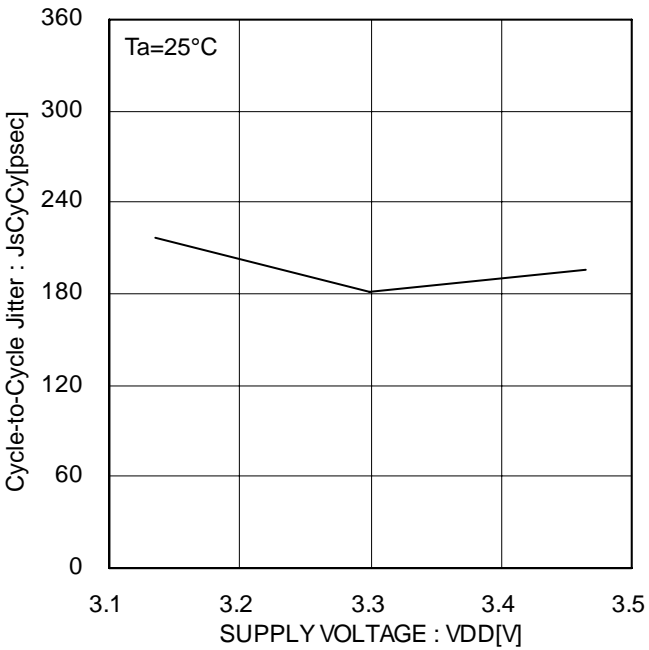

Figure 43. CLKOUT ±1.00% Modulation Cycle-to-Cycle Jitter

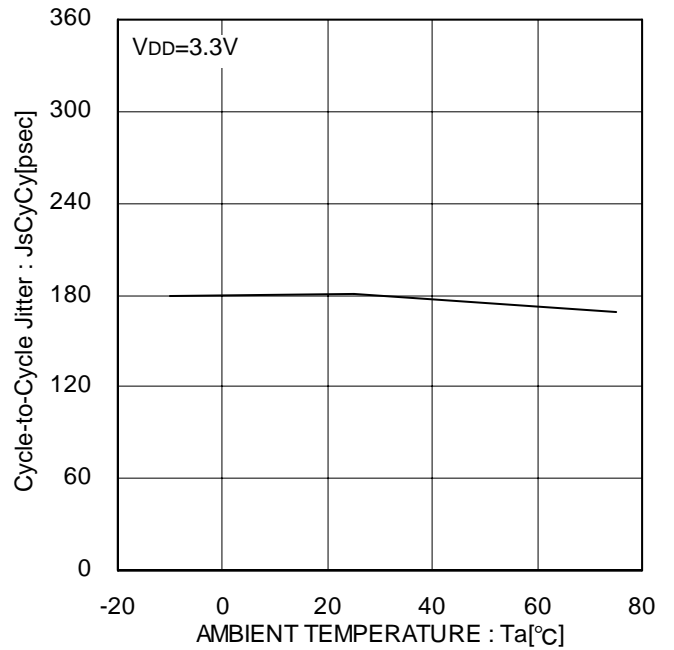

Figure 44. CLKOUT ±1.00% Modulation Cycle-to-Cycle Jitter

● Typical Performance Curves (Spread-Spectrum ON setting, Output load=15pF)

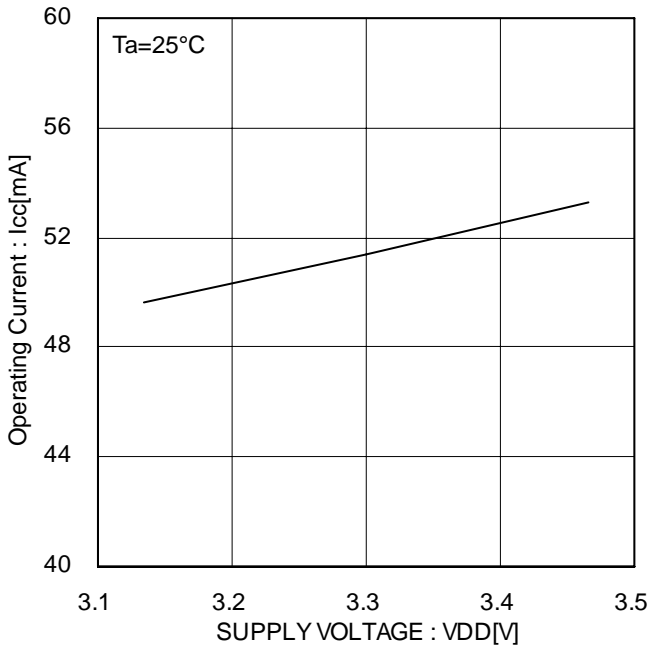

Figure 45. Operating Current

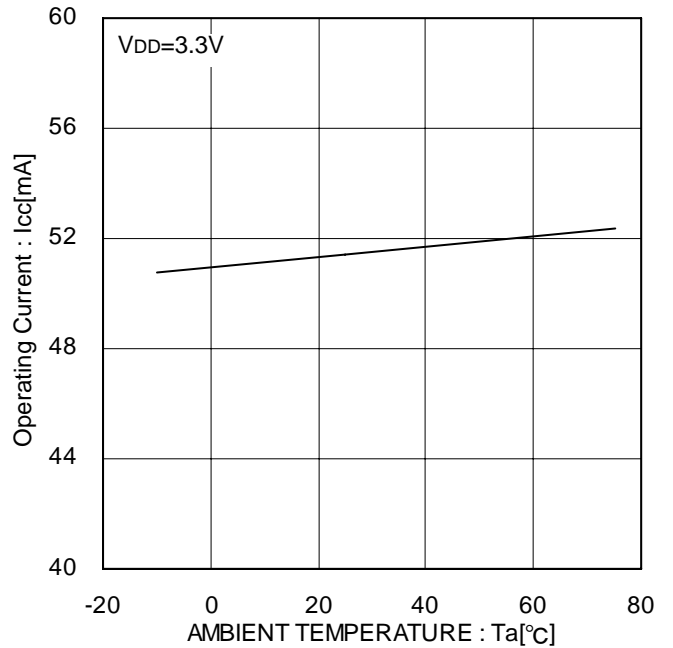

Figure 46. Operating Current

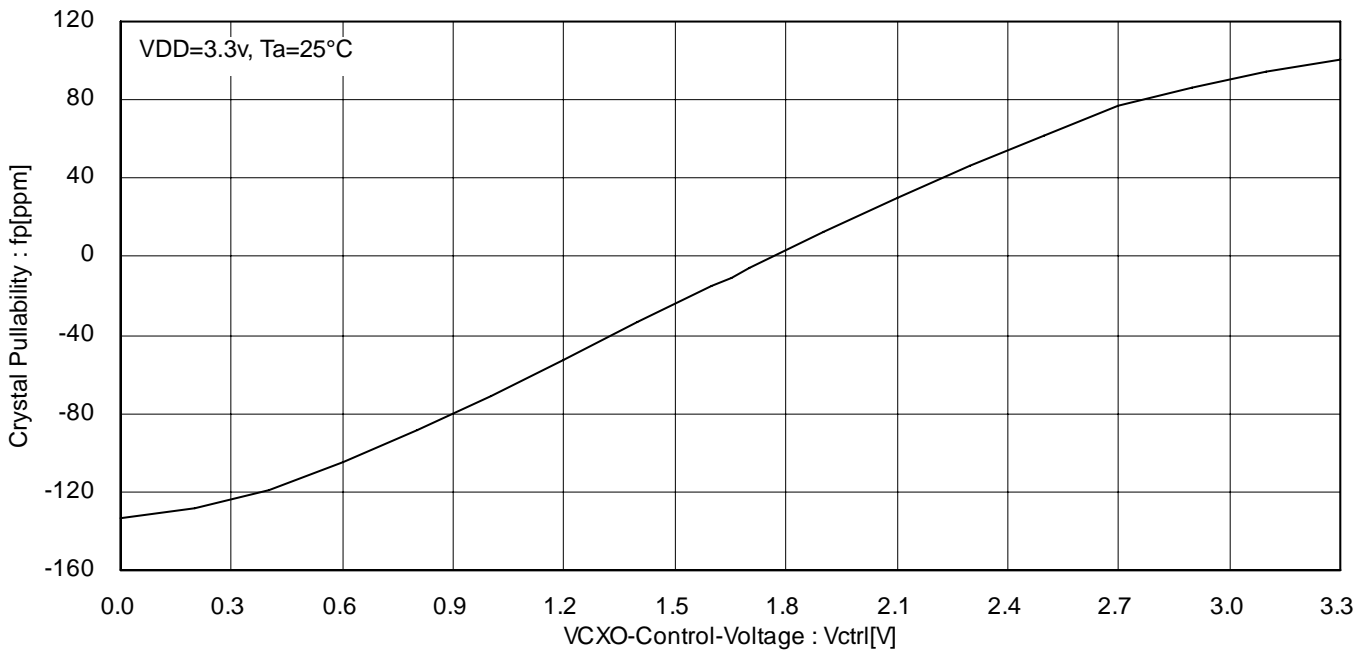

Figure 47. VCXO Crystal Pullability

VCXO Crystal Pullability has been gathered from following the evaluation environment.

Evaluation board: 70mm x 70mm x 1.6mm, 4 layers, FR-4

Using parts : 27MHz Crystal (DSX321G · 8pF load) made in DAISHINKU CORP. RD=200Ω, CL=4pF

VCXO Crystal Pullability modulates by a using crystal and a board condition.

In order to use, should be checked matting with a final board condition.

● Typical Application Circuit

In the case of Spread-Spectrum Modulation Rate $\pm 0.75\%$ setting, 7Pin_MODSEL1 connects GND, and 8Pin_MODSEL2 connect Power supply directly following the diagram.

In the case of other Modulation Rate setting, should be changed connections as a Table of Spread-Spectrum Modulation (P3).
 (In the case of $\pm 0.50\%$ setting, it is no problem that 7Pin_MODSEL1 and 8Pin_MODSEL2 are OPEN Manages.)

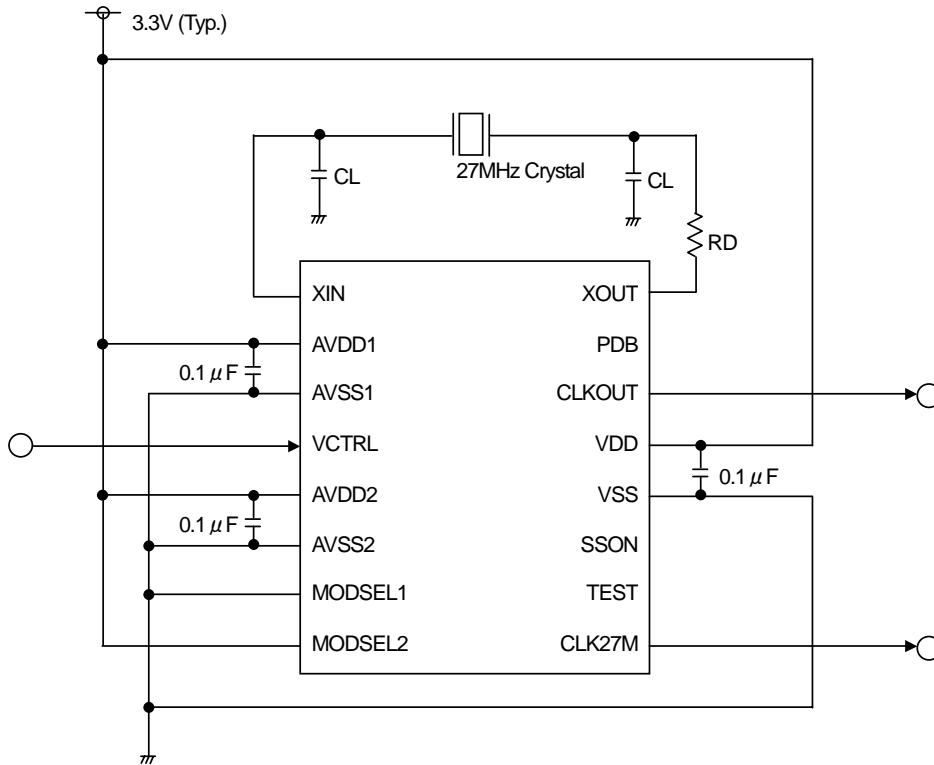

Figure 48. Modulation Rate $\pm 0.75\%$ setting Typical Application Circuit

In the case of Spread-Spectrum OFF setting, 11Pin_SSON connect GND directly as the following diagram.
 (In the case of using Spread-Spectrum, it is no problem that 11Pin_SSON are OPEN Manages.)

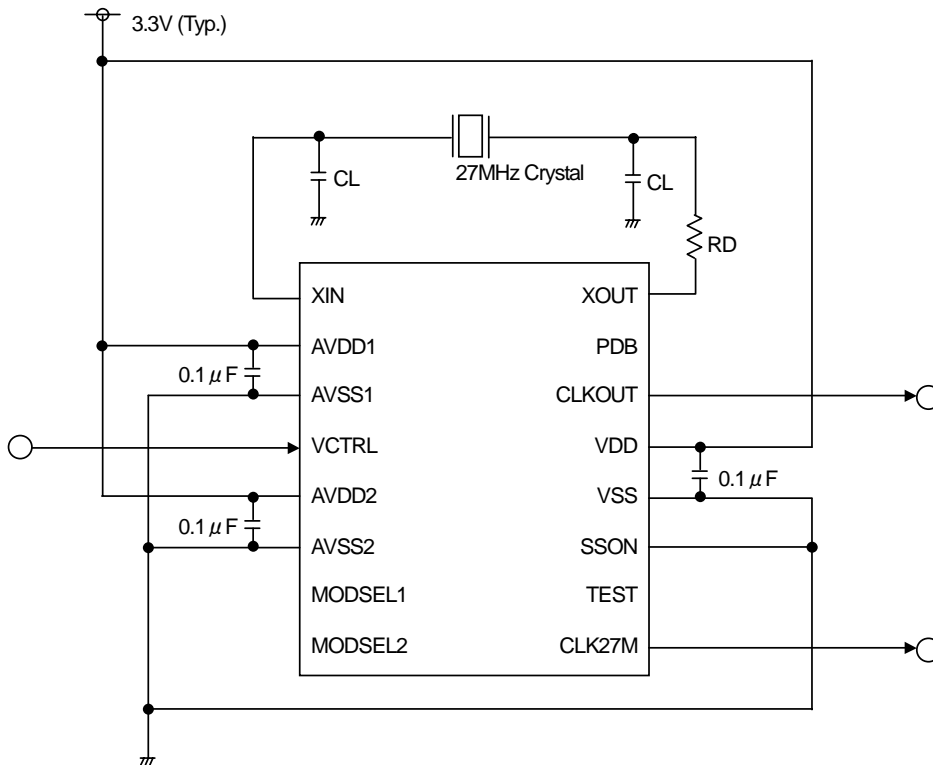

Figure 49. Spread-Spectrum OFF setting Typical Application Circuit

●Application Information

Basically, mount ICs to the printed circuit board for use.

(If the ICs are not mounted to the printed circuit board, the characteristics of ICs may not be fully demonstrated.)

Mount 0.1 μ F capacitors in the vicinity of the IC Pins between 2Pin_AVDD1, 3Pin_AVSS1, and 5Pin_AVDD2, 6Pin_AVSS2, and 12Pin_VSS, 13Pin_VDD respectively.

To obtain accurate frequency, confirm the Crystal-matching with the last board to get rid of a problem by a mass-production.

Depending on the conditions of the printed circuit board, mount an additional electrolytic capacitor between the power supply and GND terminal.

For EMI protection, it is effective to put ferrite beads in the origin of power supply to be fed to BU3087FV from the printed circuit board or to insert a capacitor (of 1 Ω or less), which bypasses high frequency desired, between the power supply and the GND terminal.

For ICs with more than one power supply, it is possible that rush current may flow instantaneously due to the internal powering sequence and delays. Therefore, give special consideration to power coupling capacitance, power wiring, width of GND wiring, and routing of wiring.

Typical Application Circuit is recommendation, but in order to use, thoroughly check to be sure characteristic.

●Power Dissipation

(SSOP-B16 package)

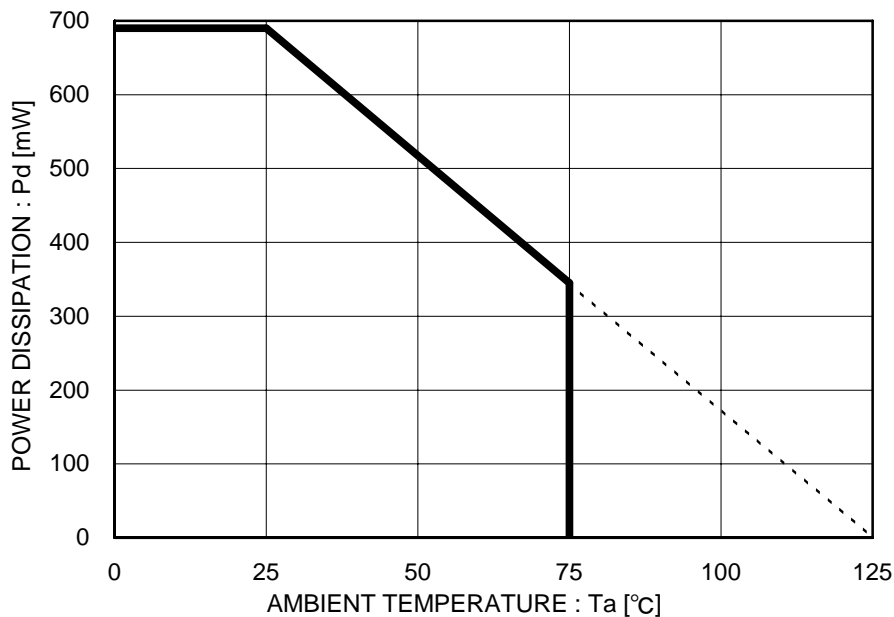

* 70mm x 70mm x 1.6mm Glass Epoxy Board

Figure 50. Power Dissipation Curve (Pd-Ta Curve)

● I/O Equivalence Circuit

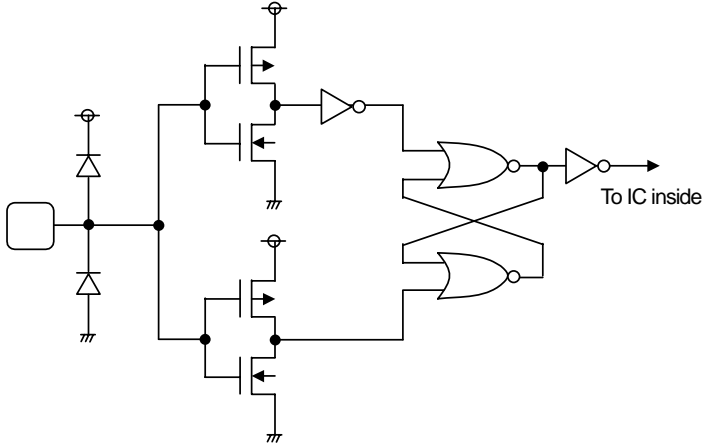
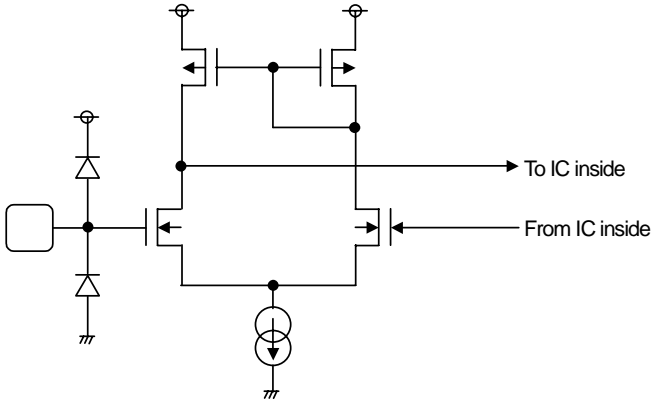
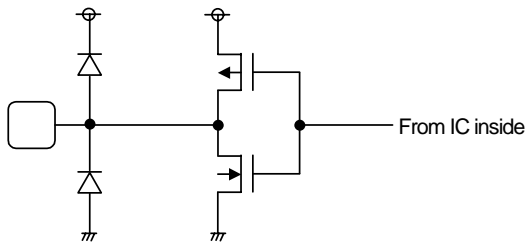
Pin No.	Equivalent Circuit
<p>Schmitt-trigger Pin</p> <p>7, 11, 15 (with Pull-Up)</p> <p>8, 10 (with Pull-Down)</p>	
<p>VCXO Control Input Pin</p> <p>4</p>	
<p>Clock Output Pin</p> <p>9, 14</p>	

● I/O Equivalence Circuit

Pin No.	Equivalent Circuit
<p>Crystal Input Pin</p> <p>1</p>	
<p>Crystal Output Pin</p> <p>16</p>	

●Operational Notes

- (1) Absolute maximum ratings
An excess in the absolute maximum ratings, such as supply voltage, temperature range of operating conditions, etc., can break down devices, thus making impossible to identify breaking mode such as a short circuit or an open circuit. If any special mode exceeding the absolute maximum ratings is assumed, consideration should be given to take physical safety measures including the use of fuses, etc.
- (2) Operating conditions
These conditions represent a range within which characteristics can be provided approximately as expected. The electrical characteristics are guaranteed under the conditions of each parameter.
- (3) Reverse connection of power supply connector
The reverse connection of power supply connector can break down ICs. Take protective measures against the breakdown due to the reverse connection, such as mounting an external diode between the power supply and the IC's power supply terminal.
- (4) Power supply line
Design PCB pattern to provide low impedance for the wiring between the power supply and the GND lines. In this regard, for the digital block power supply and the analog block power supply, even though these power supplies has the same level of potential, separate the power supply pattern for the digital block from that for the analog block, thus suppressing the diffraction of digital noises to the analog block power supply resulting from impedance common to the wiring patterns. For the GND line, give consideration to design the patterns in a similar manner.
Furthermore, for all power supply terminals to ICs, mount a capacitor between the power supply and the GND terminal. At the same time, in order to use an electrolytic capacitor, thoroughly check to be sure the characteristics of the capacitor to be used present no problem including the occurrence of capacity dropout at a low temperature, thus determining the constant.
- (5) GND voltage
Make setting of the potential of the GND terminal so that it will be maintained at the minimum in any operating state. Furthermore, check to be sure no terminals are at a potential lower than the GND voltage including an actual electric transient.
- (6) Short circuit between terminals and erroneous mounting
In order to mount ICs on a set PCB, pay thorough attention to the direction and offset of the ICs. Erroneous mounting can break down the ICs. Furthermore, if a short circuit occurs due to foreign matters entering between terminals or between the terminal and the power supply or the GND terminal, the ICs can break down.
- (7) Operation in strong electromagnetic field
Be noted that using ICs in the strong electromagnetic field can malfunction them.
- (8) Inspection with set PCB
On the inspection with the set PCB, if a capacitor is connected to a low-impedance IC terminal, the IC can suffer stress. Therefore, be sure to discharge from the set PCB by each process. Furthermore, in order to mount or dismount the set PCB to/from the jig for the inspection process, be sure to turn OFF the power supply and then mount the set PCB to the jig. After the completion of the inspection, be sure to turn OFF the power supply and then dismount it from the jig. In addition, for protection against static electricity, establish a ground for the assembly process and pay thorough attention to the transportation and the storage of the set PCB.
- (9) Input terminals
In terms of the construction of IC, parasitic elements are inevitably formed in relation to potential. The operation of the parasitic element can cause interference with circuit operation, thus resulting in a malfunction and then breakdown of the input terminal. Therefore, pay thorough attention not to handle the input terminals, such as to apply to the input terminals a voltage lower than the GND respectively, so that any parasitic element will operate. Furthermore, do not apply a voltage to the input terminals when no power supply voltage is applied to the IC. In addition, even if the power supply voltage is applied, apply to the input terminals a voltage lower than the power supply voltage or within the guaranteed value of electrical characteristics.
- (10) Ground wiring pattern
If small-signal GND and large-current GND are provided, It will be recommended to separate the large-current GND pattern from the small-signal GND pattern and establish a single ground at the reference point of the set PCB so that resistance to the wiring pattern and voltage fluctuations due to a large current will cause no fluctuations in voltages of the small-signal GND. Pay attention not to cause fluctuations in the GND wiring pattern of external parts as well.
- (11) External capacitor
In order to use a ceramic capacitor as the external capacitor, determine the constant with consideration given to a degradation in the nominal capacitance due to DC bias and changes in the capacitance due to temperature, etc.
- (12) Thermal design
Perform thermal design in which there are adequate margins by taking into account the power dissipation (Pd) in actual states of use.

Status of this document

The Japanese version of this document is formal specification. A customer may use this translation version only for a reference to help reading the formal version.

If there are any differences in translation version of this document formal version takes priority.

●Ordering Information

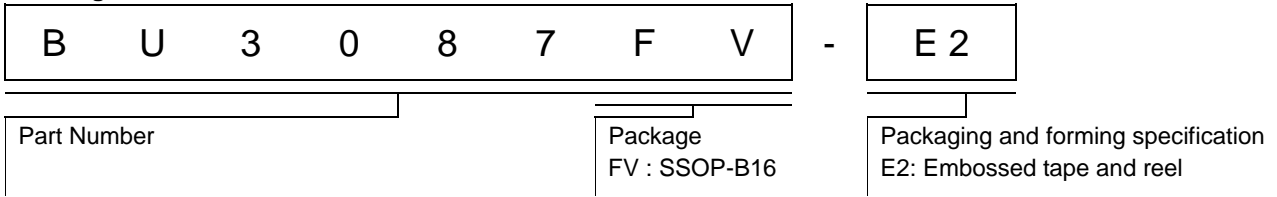

●Physical Dimension Tape and Reel Information

SSOP-B16

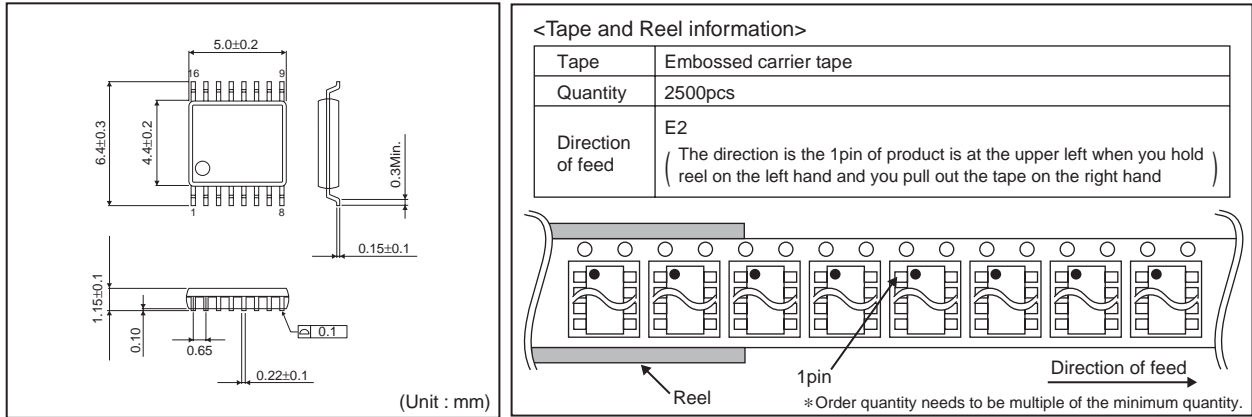

●Marking Diagram

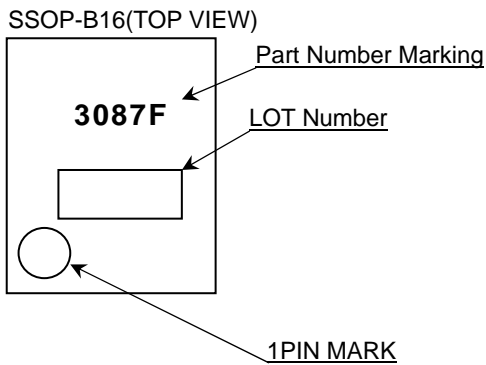

●Revision History

Date	Revision	Changes
17.AUG.2012	001	New Release

Notice

Precaution on using ROHM Products

- Our Products are designed and manufactured for application in ordinary electronic equipments (such as AV equipment, OA equipment, telecommunication equipment, home electronic appliances, amusement equipment, etc.). If you intend to use our Products in devices requiring extremely high reliability (such as medical equipment ^(Note 1), transport equipment, traffic equipment, aircraft/spacecraft, nuclear power controllers, fuel controllers, car equipment including car accessories, safety devices, etc.) and whose malfunction or failure may cause loss of human life, bodily injury or serious damage to property ("Specific Applications"), please consult with the ROHM sales representative in advance. Unless otherwise agreed in writing by ROHM in advance, ROHM shall not be in any way responsible or liable for any damages, expenses or losses incurred by you or third parties arising from the use of any ROHM's Products for Specific Applications.

(Note1) Medical Equipment Classification of the Specific Applications

JAPAN	USA	EU	CHINA
CLASS III	CLASS III	CLASS II b	CLASS III
CLASS IV		CLASS III	

- ROHM designs and manufactures its Products subject to strict quality control system. However, semiconductor products can fail or malfunction at a certain rate. Please be sure to implement, at your own responsibilities, adequate safety measures including but not limited to fail-safe design against the physical injury, damage to any property, which a failure or malfunction of our Products may cause. The following are examples of safety measures:
 - Installation of protection circuits or other protective devices to improve system safety
 - Installation of redundant circuits to reduce the impact of single or multiple circuit failure
- Our Products are designed and manufactured for use under standard conditions and not under any special or extraordinary environments or conditions, as exemplified below. Accordingly, ROHM shall not be in any way responsible or liable for any damages, expenses or losses arising from the use of any ROHM's Products under any special or extraordinary environments or conditions. If you intend to use our Products under any special or extraordinary environments or conditions (as exemplified below), your independent verification and confirmation of product performance, reliability, etc. prior to use, must be necessary:
 - Use of our Products in any types of liquid, including water, oils, chemicals, and organic solvents
 - Use of our Products outdoors or in places where the Products are exposed to direct sunlight or dust
 - Use of our Products in places where the Products are exposed to sea wind or corrosive gases, including Cl₂, H₂S, NH₃, SO₂, and NO₂
 - Use of our Products in places where the Products are exposed to static electricity or electromagnetic waves
 - Use of our Products in proximity to heat-producing components, plastic cords, or other flammable items
 - Sealing or coating our Products with resin or other coating materials
 - Use of our Products without cleaning residue of flux (even if you use no-clean type fluxes, cleaning residue of flux is recommended); or Washing our Products by using water or water-soluble cleaning agents for cleaning residue after soldering
 - Use of the Products in places subject to dew condensation
- The Products are not subject to radiation-proof design.
- Please verify and confirm characteristics of the final or mounted products in using the Products.
- In particular, if a transient load (a large amount of load applied in a short period of time, such as pulse. is applied, confirmation of performance characteristics after on-board mounting is strongly recommended. Avoid applying power exceeding normal rated power; exceeding the power rating under steady-state loading condition may negatively affect product performance and reliability.
- De-rate Power Dissipation (Pd) depending on Ambient temperature (Ta). When used in sealed area, confirm the actual ambient temperature.
- Confirm that operation temperature is within the specified range described in the product specification.
- ROHM shall not be in any way responsible or liable for failure induced under deviant condition from what is defined in this document.

Precaution for Mounting / Circuit board design

- When a highly active halogenous (chlorine, bromine, etc.) flux is used, the residue of flux may negatively affect product performance and reliability.
- In principle, the reflow soldering method must be used; if flow soldering method is preferred, please consult with the ROHM representative in advance.

For details, please refer to ROHM Mounting specification

Precautions Regarding Application Examples and External Circuits

1. If change is made to the constant of an external circuit, please allow a sufficient margin considering variations of the characteristics of the Products and external components, including transient characteristics, as well as static characteristics.
2. You agree that application notes, reference designs, and associated data and information contained in this document are presented only as guidance for Products use. Therefore, in case you use such information, you are solely responsible for it and you must exercise your own independent verification and judgment in the use of such information contained in this document. ROHM shall not be in any way responsible or liable for any damages, expenses or losses incurred by you or third parties arising from the use of such information.

Precaution for Electrostatic

This Product is electrostatic sensitive product, which may be damaged due to electrostatic discharge. Please take proper caution in your manufacturing process and storage so that voltage exceeding the Products maximum rating will not be applied to Products. Please take special care under dry condition (e.g. Grounding of human body / equipment / solder iron, isolation from charged objects, setting of ionizer, friction prevention and temperature / humidity control).

Precaution for Storage / Transportation

1. Product performance and soldered connections may deteriorate if the Products are stored in the places where:
 - [a] the Products are exposed to sea winds or corrosive gases, including Cl₂, H₂S, NH₃, SO₂, and NO₂
 - [b] the temperature or humidity exceeds those recommended by ROHM
 - [c] the Products are exposed to direct sunshine or condensation
 - [d] the Products are exposed to high Electrostatic
2. Even under ROHM recommended storage condition, solderability of products out of recommended storage time period may be degraded. It is strongly recommended to confirm solderability before using Products of which storage time is exceeding the recommended storage time period.
3. Store / transport cartons in the correct direction, which is indicated on a carton with a symbol. Otherwise bent leads may occur due to excessive stress applied when dropping of a carton.
4. Use Products within the specified time after opening a humidity barrier bag. Baking is required before using Products of which storage time is exceeding the recommended storage time period.

Precaution for Product Label

QR code printed on ROHM Products label is for ROHM's internal use only.

Precaution for Disposition

When disposing Products please dispose them properly using an authorized industry waste company.

Precaution for Foreign Exchange and Foreign Trade act

Since our Products might fall under controlled goods prescribed by the applicable foreign exchange and foreign trade act, please consult with ROHM representative in case of export.

Precaution Regarding Intellectual Property Rights

1. All information and data including but not limited to application example contained in this document is for reference only. ROHM does not warrant that foregoing information or data will not infringe any intellectual property rights or any other rights of any third party regarding such information or data. ROHM shall not be in any way responsible or liable for infringement of any intellectual property rights or other damages arising from use of such information or data.:
2. No license, expressly or implied, is granted hereby under any intellectual property rights or other rights of ROHM or any third parties with respect to the information contained in this document.

Other Precaution

1. This document may not be reprinted or reproduced, in whole or in part, without prior written consent of ROHM.
2. The Products may not be disassembled, converted, modified, reproduced or otherwise changed without prior written consent of ROHM.
3. In no event shall you use in any way whatsoever the Products and the related technical information contained in the Products or this document for any military purposes, including but not limited to, the development of mass-destruction weapons.
4. The proper names of companies or products described in this document are trademarks or registered trademarks of ROHM, its affiliated companies or third parties.

General Precaution

1. Before you use our Products, you are requested to carefully read this document and fully understand its contents. ROHM shall not be in any way responsible or liable for failure, malfunction or accident arising from the use of any ROHM's Products against warning, caution or note contained in this document.
2. All information contained in this document is current as of the issuing date and subject to change without any prior notice. Before purchasing or using ROHM's Products, please confirm the latest information with a ROHM sales representative.
3. The information contained in this document is provided on an "as is" basis and ROHM does not warrant that all information contained in this document is accurate and/or error-free. ROHM shall not be in any way responsible or liable for any damages, expenses or losses incurred by you or third parties resulting from inaccuracy or errors of or concerning such information.