

阅读申明

- 1.本站收集的数据手册和产品资料都来自互联网，版权归原作者所有。如读者和版权方有任何异议请及时告之，我们将妥善解决。
- 2.本站提供的中文数据手册是英文数据手册的中文翻译，其目的是协助用户阅读，该译文无法自动跟随原稿更新，同时也可能存在翻译上的不当。建议读者以英文原稿为参考以便获得更精准的信息。
- 3.本站提供的产品资料，来自厂商的技术支持或者使用者的心得体会等，其内容可能存在描述上的差异，建议读者做出适当判断。
- 4.如需与我们联系，请发邮件到marketing@iczoom.com，主题请标有“数据手册”字样。

Read Statement

1. The datasheets and other product information on the site are all from network reference or other public materials, and the copyright belongs to the original author and original published source. If readers and copyright owners have any objections, please contact us and we will deal with it in a timely manner.
2. The Chinese datasheets provided on the website is a Chinese translation of the English datasheets. Its purpose is for reader's learning exchange only and do not involve commercial purposes. The translation cannot be automatically updated with the original manuscript, and there may also be improper translations. Readers are advised to use the English manuscript as a reference for more accurate information.
3. All product information provided on the website refer to solutions from manufacturers' technical support or users the contents may have differences in description, and readers are advised to take the original article as the standard.
4. If you have any questions, please contact us at marketing@iczoom.com and mark the subject with "Datasheets" .

TABLE OF CONTENTS

| | | | |
|--|----|--|----|
| Features | 1 | Register 4 | 26 |
| Applications | 1 | Register 5 | 27 |
| General Description | 1 | Register 6 | 28 |
| Functional Block Diagram | 1 | Register 7 | 30 |
| Revision History | 3 | Register 8 | 31 |
| Specifications | 4 | Register 9 | 31 |
| Timing Characteristics | 7 | Register 10 | 32 |
| Absolute Maximum Ratings | 8 | Register 11 | 32 |
| Transistor Count | 8 | Register 12 | 33 |
| ESD Caution | 8 | Register Initialization Sequence | 33 |
| Pin Configuration and Function Descriptions | 9 | Frequency Update Sequence | 33 |
| Typical Performance Characteristics | 11 | RF Synthesizer—A Worked Example | 34 |
| Circuit Description | 16 | Reference Doubler and Reference Divider | 34 |
| Reference Input | 16 | Spurious Optimization and Fast Lock | 34 |
| RF N Divider | 16 | Optimizing Jitter | 35 |
| Phase Frequency Detector (PFD) and Charge Pump | 17 | Spur Mechanisms | 35 |
| MUXOUT and Lock Detect | 17 | Lock Time | 35 |
| Input Shift Registers | 17 | Applications Information | 36 |
| Program Modes | 18 | Power Supplies | 36 |
| VCO | 18 | Printed Circuit Board (PCB) Design Guidelines for a Chip-Scale Package | 36 |
| Output Stage | 18 | Output Matching | 37 |
| Register Maps | 20 | Outline Dimensions | 38 |
| Register 0 | 22 | Ordering Guide | 38 |
| Register 1 | 23 | | |
| Register 2 | 24 | | |
| Register 3 | 25 | | |

REVISION HISTORY

4/2017—Rev. B to Rev C

Changes to Figure 55 and Power Supplies Section36

1/2017—Rev. A to Rev B

Change to Features Section.....1
 Changes to Doubler Enabled Parameter and Endnote 3, Table 14
 Changes to Table 27
 Changes to Table 38
 Changes to Table 49
 Changes to Reference Input Section and Figure 32 Caption.....16
 Changes to Table 619
 Changes to Phase Resync Section25
 Change to Reference Doubler Section.....26
 Changes to Power-Down Section27
 Changes to Negative Bleed Section.....28
 Changes to Loss of Lock (LOL) Mode Section.....30
 Changes to Register Initialization Sequence Section and Frequency Update Sequence Section33
 Changes to Power Supplies Section and Figure 5536

2/2015—Rev. 0 to Rev. A

Changed Register 5, Bit DB5 Value from 0 to 1 Throughout
 Changed Register 5 Default Value from 0x00800005 to 0x00800025 Throughout
 Changed Register 8 Default Value from 0x102D4028 to 0x102D0428 Throughout
 Changes to Table 14
 Changed Timing Diagram Section to Write Timing Diagram Section7
 Changes to Table 410
 Changes to Figure 4 to Figure 611

Added Figure 7 to Figure 9; Renumbered Sequentially.....11
 Changes to Figure 10 to Figure 1812
 Changes to Figure 2013
 Changes to Figure 23 and Figure 2714
 Changes to Figure 28 to Figure 30 and Figure 31 Caption.....15
 Changes to Reference Input Section and INT, FRAC, MOD, and R Counter Relationship Section16
 Changes to Phase Frequency Detector (PFD) and Charge Pump Section17
 Changes to VCO Section and Output Stage Section18
 Changes to Automatic Calibration (AUTOCAL) Section.....22
 Changes to Figure 4324
 Changes to MUXOUT Section.....26
 Changes to Reference Mode Section and Counter Reset Section27
 Changes to Negative Bleed Section.....28
 Changes to Charge Pump Bleed Current Section.....29
 Changes to Register 9 Section, VCO Band Division Section, Timeout Section, Automatic Level Calibration Timeout Section, and Synthesizer Lock Timeout Section31
 Changes to ADC Conversion Clock (ADC_CLK_DIV) Section32
 Changes to Phase Resync Clock Divider Value Section and Frequency Update Sequence Section.....33
 Changes to RF Synthesizer—A Worked Example Section34
 Changes to Lock Time Section and Automatic Level Calibration Timeout Section35
 Added Lock Time—A Worked Example Section35

10/2014—Revision 0: Initial Version

SPECIFICATIONS

$AV_{DD} = DV_{DD} = V_{RF} = 3.3 \text{ V} \pm 5\%$, $4.75 \text{ V} \leq V_P = V_{VCO} \leq 5.25 \text{ V}$, $A_{GND} = CP_{GND} = A_{GNDVCO} = SD_{GND} = A_{GNDRF} = 0 \text{ V}$, $R_{SET} = 5.1 \text{ k}\Omega$, dBm referred to 50Ω , $T_A = T_{MIN}$ to T_{MAX} , unless otherwise noted.

Table 1.

| Parameter | Symbol | Min | Typ | Max | Unit | Test Conditions/Comments |
|---|-------------------|-----------------|-----------|-----------|---------------|---|
| REF _{IN} A/REF _{IN} B CHARACTERISTICS | | | | | | |
| Input Frequency | | | | | | For $f < 10 \text{ MHz}$, ensure slew rate $> 21 \text{ V}/\mu\text{s}$ |
| Single-Ended Mode | | 10 | | 250 | MHz | |
| Differential Mode | | 10 | | 600 | MHz | |
| Doubler Enabled | | | | 100 | MHz | Doubler is set in Register 4, Bit DB26 |
| Input Sensitivity | | | | | | |
| Single-Ended Mode | | 0.4 | | AV_{DD} | V p-p | REF _{IN} A biased at $AV_{DD}/2$; ac coupling ensures $AV_{DD}/2$ bias |
| Differential Mode | | 0.4 | | 1.8 | V p-p | LVDS and LVPECL compatible, REF _{IN} A/REF _{IN} B biased at 2.1 V; ac coupling ensures 2.1 V bias |
| Input Capacitance | | | | | | |
| Single-Ended Mode | | | 6.9 | | pF | |
| Differential Mode | | | 1.4 | | pF | |
| Input Current | | | | ± 60 | μA | Single-ended reference programmed |
| | | | | ± 250 | μA | Differential reference programmed |
| Phase Detector Frequency | | | | 125 | MHz | |
| CHARGE PUMP (CP) | | | | | | |
| Charge Pump Current, Sink/Source | I_{CP} | | | | | $R_{SET} = 5.1 \text{ k}\Omega$ |
| High Value | | | 4.8 | | mA | |
| Low Value | | | 0.3 | | mA | |
| R_{SET} Range | | | 5.1 | | k Ω | Fixed |
| Current Matching | | | 3 | | % | $0.5 \text{ V} \leq V_{CP}^1 \leq V_P - 0.5 \text{ V}$ |
| I_{CP} vs. V_{CP} | | | 3 | | % | $0.5 \text{ V} \leq V_{CP}^1 \leq V_P - 0.5 \text{ V}$ |
| I_{CP} vs. Temperature | | | 1.5 | | % | $V_{CP}^1 = 2.5 \text{ V}$ |
| LOGIC INPUTS | | | | | | |
| Input High Voltage | V_{INH} | 1.5 | | | V | |
| Input Low Voltage | V_{INL} | | | 0.6 | V | |
| Input Current | I_{INH}/I_{INL} | | | ± 1 | μA | |
| Input Capacitance | C_{IN} | | 3.0 | | pF | |
| LOGIC OUTPUTS | | | | | | |
| Output High Voltage | V_{OH} | $DV_{DD} - 0.4$ | | | V | |
| | | 1.5 | 1.8 | | V | 1.8 V output selected |
| Output High Current | I_{OH} | | | 500 | μA | |
| Output Low Voltage | V_{OL} | | | 0.4 | V | $I_{OL}^2 = 500 \mu\text{A}$ |
| POWER SUPPLIES | | | | | | |
| Analog Power | AV_{DD} | 3.15 | | 3.45 | V | See Table 6 |
| Digital Power and RF Supply Voltage | DV_{DD}, V_{RF} | | AV_{DD} | | | Voltages must equal AV_{DD} |
| Charge Pump and VCO Supply Voltage | V_P, V_{VCO} | 4.75 | 5.0 | 5.25 | V | V_P must equal V_{VCO} |
| Charge Pump Supply Power Current | I_P | | 8 | 9 | mA | |
| $D I_{DD} + A I_{DD}^3$ | | | 62 | 69 | mA | |
| Output Dividers | | | 6 to 36 | | mA | Each output divide by 2 consumes 6 mA |
| Supply Current | I_{VCO} | | 70 | 85 | mA | |

| Parameter | Symbol | Min | Typ | Max | Unit | Test Conditions/Comments |
|---|---------------------------------|--------|------|-------|--------|--|
| RF _{OUTA±} /RF _{OUTB} Supply Current | I _{RF_{OUTX±}} | | | | | RF _{OUTA±} output stage is programmable; enabling RF _{OUTB} draws negligible extra current |
| | | | 16 | 20 | mA | −4 dBm setting |
| | | | 30 | 35 | mA | −1 dBm setting |
| | | | 42 | 50 | mA | 2 dBm setting |
| | | | 55 | 70 | mA | 5 dBm setting |
| Low Power Sleep Mode | | | 500 | | μA | Hardware power-down selected |
| | | | 1000 | | μA | Software power-down selected |
| RF OUTPUT CHARACTERISTICS | | | | | | |
| VCO Frequency Range | | 3400 | | 6800 | MHz | Fundamental VCO range |
| RF _{OUTB} Output Frequency | | 6800 | | 13600 | MHz | 2× VCO output (RF _{OUTB}) |
| RF _{OUTA+} /RF _{OUTA−} Output Frequency | | 53.125 | | 6800 | MHz | |
| VCO Sensitivity | K _v | | 15 | | MHz/V | |
| Frequency Pushing (Open-Loop) | | | 15 | | MHz/V | |
| Frequency Pulling (Open-Loop) | | | 0.5 | | MHz | Voltage standing wave ratio (VSWR) = 2:1 RF _{OUTA+} /RF _{OUTA−} |
| | | | 30 | | MHz | VSWR = 2:1 RF _{OUTB} |
| Harmonic Content | | | | | | |
| Second | | | −27 | | dBc | Fundamental VCO output (RF _{OUTA+}) |
| | | | −22 | | dBc | Divided VCO output (RF _{OUTA+}) |
| Third | | | −20 | | dBc | Fundamental VCO output (RF _{OUTA+}) |
| | | | −12 | | dBc | Divided VCO output (RF _{OUTA+}) |
| Fundamental VCO Feedthrough | | | −8 | | dBm | RF _{OUTB} = 10 GHz |
| | | | −55 | | dBc | RF _{OUTA+} /RF _{OUTA−} = 1 GHz; VCO frequency = 4 GHz |
| RF Output Power ⁴ | | | +8 | | dBm | RF _{OUTA+} = 1 GHz; 7.5 nH inductor to V _{RF} |
| | | | −3 | | dBm | RF _{OUTA+} /RF _{OUTA−} = 6.8 GHz; 7.5 nH inductor to V _{RF} |
| | | | 1 | | dBm | RF _{OUTB} = 6.8 GHz |
| | | | −1 | | dBm | RF _{OUTB} = 13.6 GHz |
| RF Output Power Variation | | | ±1 | | dB | RF _{OUTA+} /RF _{OUTA−} = 5 GHz |
| | | | ±1 | | dB | RF _{OUTB} = 10 GHz |
| RF Output Power Variation (over Frequency) | | | ±6 | | dB | RF _{OUTA+} /RF _{OUTA−} = 1 GHz to 6.8 GHz |
| | | | ±4 | | dB | RF _{OUTB} = 6.8 GHz to 13.6 GHz |
| Level of Signal with RF Output Disabled | | | −60 | | dBm | RF _{OUTA+} /RF _{OUTA−} = 1 GHz |
| | | | −30 | | dBm | RF _{OUTA+} /RF _{OUTA−} = 6.8 GHz |
| | | | −15 | | dBm | RF _{OUTB} = 6.8 GHz |
| | | | −17 | | dBm | RF _{OUTB} = 13.6 GHz |
| NOISE CHARACTERISTICS | | | | | | |
| Fundamental VCO Phase Noise Performance | | | | | | VCO noise in open-loop conditions |
| | | | −116 | | dBc/Hz | 100 kHz offset from 3.4 GHz carrier |
| | | | −136 | | dBc/Hz | 800 kHz offset from 3.4 GHz carrier |
| | | | −138 | | dBc/Hz | 1 MHz offset from 3.4 GHz carrier |
| | | | −155 | | dBc/Hz | 10 MHz offset from 3.4 GHz carrier |
| | | | −113 | | dBc/Hz | 100 kHz offset from 5.0 GHz carrier |
| | | | −133 | | dBc/Hz | 800 kHz offset from 5.0 GHz carrier |
| | | | −135 | | dBc/Hz | 1 MHz offset from 5.0 GHz carrier |
| | | | −153 | | dBc/Hz | 10 MHz offset from 5.0 GHz carrier |
| | | | −110 | | dBc/Hz | 100 kHz offset from 6.8 GHz carrier |
| | | | −130 | | dBc/Hz | 800 kHz offset from 6.8 GHz carrier |
| | | | −132 | | dBc/Hz | 1 MHz offset from 6.8 GHz carrier |
| | | | −150 | | dBc/Hz | 10 MHz offset from 6.8 GHz carrier |

| Parameter | Symbol | Min | Typ | Max | Unit | Test Conditions/Comments |
|---|--------|-----|------|-----|--------|--------------------------------------|
| VCO 2x Phase Noise Performance | | | | | | VCO noise in open-loop conditions |
| | | | -110 | | dBc/Hz | 100 kHz offset from 6.8 GHz carrier |
| | | | -130 | | dBc/Hz | 800 kHz offset from 6.8 GHz carrier |
| | | | -132 | | dBc/Hz | 1 MHz offset from 6.8 GHz carrier |
| | | | -149 | | dBc/Hz | 10 MHz offset from 6.8 GHz carrier |
| | | | -107 | | dBc/Hz | 100 kHz offset from 10 GHz carrier |
| | | | -127 | | dBc/Hz | 800 kHz offset from 10 GHz carrier |
| | | | -129 | | dBc/Hz | 1 MHz offset from 10 GHz carrier |
| | | | -147 | | dBc/Hz | 10 MHz offset from 10 GHz carrier |
| | | | -103 | | dBc/Hz | 100 kHz offset from 13.6 GHz carrier |
| | | | -124 | | dBc/Hz | 800 kHz offset from 13.6 GHz carrier |
| | | | -126 | | dBc/Hz | 1 MHz offset from 13.6 GHz carrier |
| | | | -144 | | dBc/Hz | 10 MHz offset from 13.6 GHz carrier |
| Normalized In-Band Phase Noise Floor | | | | | | |
| Fractional Channel ⁵ | | | -221 | | dBc/Hz | |
| Integer Channel ⁶ | | | -223 | | dBc/Hz | |
| Normalized 1/f Noise, PN_{1-f} ⁷ | | | -116 | | dBc/Hz | 10 kHz offset; normalized to 1 GHz |
| Integrated RMS Jitter | | | 150 | | fs | |
| Spurious Signals due to PFD Frequency | | | -80 | | dBc | |

¹ V_{CP} is the voltage at the CP_{OUT} pin.

² I_{OL} is the output low current.

³ $T_A = 25^\circ\text{C}$; $AV_{DD} = DV_{DD} = V_{RF} = 3.3\text{ V}$; $V_{VCO} = V_P = 5.0\text{ V}$; prescaler = 4/5; $f_{REFIN} = 122.88\text{ MHz}$; $f_{PFD} = 61.44\text{ MHz}$; and $f_{RF} = 1650\text{ MHz}$. For the nominal $DI_{DD} + AI_{DD}$ (62 mA): $DI_{DD} = 15\text{ mA}$ (typical), AI_{DD} (Pin 5) = 24 mA (typical), AI_{DD} (Pin 16) = 23 mA (typical).

⁴ RF output power using the [EV-ADF5355SD1Z](#) evaluation board measured into a spectrum analyzer, with board and cable losses de-embedded. Unused RF output pins are terminated in 50 Ω .

⁵ Use this value to calculate the phase noise for any application. To calculate in-band phase noise performance as seen at the VCO output, use the following formula: $-221 + 10\log(f_{PFD}) + 20\log N$. The value given is the lowest noise mode for the fractional channel.

⁶ Use this value to calculate the phase noise for any application. To calculate in-band phase noise performance as seen at the VCO output, use the following formula: $-223 + 10\log(f_{PFD}) + 20\log N$. The value given is the lowest noise mode for the integer channel.

⁷ The PLL phase noise is composed of 1/f (flicker) noise plus the normalized PLL noise floor. The formula for calculating the 1/f noise contribution at an RF frequency (f_{RF}) and at a frequency offset (f) is given by $PN = P_{1-f} + 10\log(10\text{ kHz}/f) + 20\log(f_{RF}/1\text{ GHz})$. Both the normalized phase noise floor and flicker noise are modeled in the [ADIsimPLL](#) design tool.

TIMING CHARACTERISTICS

$AV_{DD} = DV_{DD} = V_{RF} = 3.3\text{ V} \pm 5\%$, $4.75\text{ V} \leq V_P = V_{VCO} \leq 5.25\text{ V}$, $A_{GND} = CP_{GND} = A_{GNDVCO} = SD_{GND} = A_{GNDRF} = 0\text{ V}$, $R_{SET} = 5.1\text{ k}\Omega$, dBm referred to $50\ \Omega$, $T_A = T_{MIN}$ to T_{MAX} , unless otherwise noted.

Table 2. Write Timing

| Parameter | Limit | Unit | Description |
|-----------|---|---------|---|
| f_{CLK} | 50 | MHz max | Serial peripheral interface CLK frequency |
| t_1 | 10 | ns min | LE setup time |
| t_2 | 5 | ns min | DATA to CLK setup time |
| t_3 | 5 | ns min | DATA to CLK hold time |
| t_4 | 10 | ns min | CLK high duration |
| t_5 | 10 | ns min | CLK low duration |
| t_6 | 5 | ns min | CLK to LE setup time |
| t_7 | 20 (or $2/f_{FPD}$, whichever is longer) | ns min | LE pulse width |

Write Timing Diagram

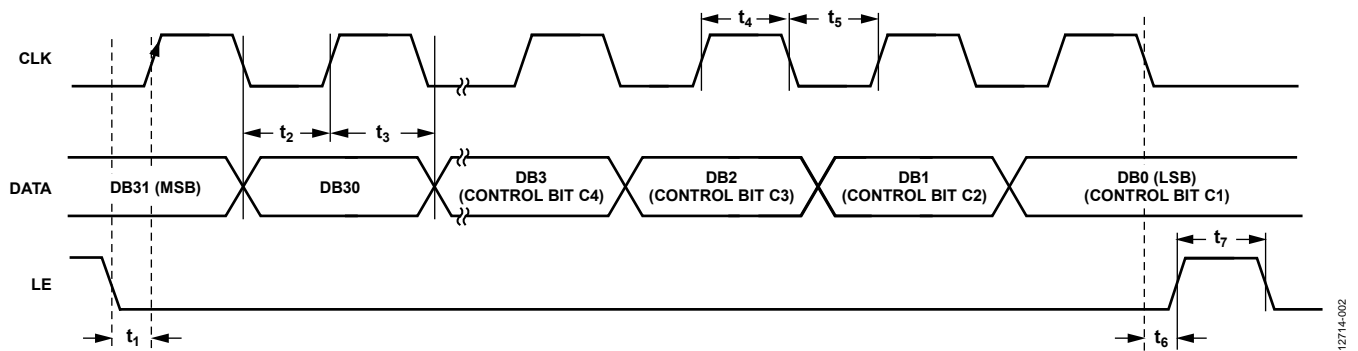

Figure 2. Write Timing Diagram

12714-002

ABSOLUTE MAXIMUM RATINGS

$T_A = 25^\circ\text{C}$, unless otherwise noted.

Table 3.

| Parameter | Rating |
|---|-----------------------------|
| V_{RF} , DV_{DD} , AV_{DD} to GND ^{1,2} | −0.3 V to +3.6 V |
| AV_{DD} to DV_{DD} | −0.3 V to +0.3 V |
| V_P , V_{VCO} to GND ¹ | −0.3 V to +5.8 V |
| CP_{OUT} to GND ¹ | −0.3 V to $V_P + 0.3$ V |
| Digital Input/Output Voltage to GND ¹ | −0.3 V to $DV_{DD} + 0.3$ V |
| Analog Input/Output Voltage to GND ¹ | −0.3 V to $AV_{DD} + 0.3$ V |
| $REF_{IN,A}$, $REF_{IN,B}$ to GND ¹ | −0.3 V to $AV_{DD} + 0.3$ V |
| $REF_{IN,A}$ to $REF_{IN,B}$ | ±2.1 V |
| Operating Temperature Range | −40°C to +85°C |
| Storage Temperature Range | −65°C to +125°C |
| Maximum Junction Temperature | 150°C |
| θ_{JA} , Thermal Impedance Paddle Soldered to GND ¹ | 27.3°C/W |
| Reflow Soldering | |
| Peak Temperature | 260°C |
| Time at Peak Temperature | 40 sec |
| Electrostatic Discharge (ESD) | |
| Charged Device Model | 1000 V |
| Human Body Model | 2500 V |

¹ GND = $A_{GND} = SD_{GND} = A_{GNDRF} = A_{GNDVCO} = CP_{GND} = 0$ V.

² Do not connect V_{RF} to DV_{DD} .

Stresses at or above those listed under Absolute Maximum Ratings may cause permanent damage to the product. This is a stress rating only; functional operation of the product at these or any other conditions above those indicated in the operational section of this specification is not implied. Operation beyond the maximum operating conditions for extended periods may affect product reliability.

The ADF5355 is a high performance RF integrated circuit with an ESD rating of 2.5 kV and is ESD sensitive. Take proper precautions for handling and assembly.

TRANSISTOR COUNT

The transistor count for the ADF5355 is 103,665 (CMOS) and 3214 (bipolar).

ESD CAUTION



ESD (electrostatic discharge) sensitive device. Charged devices and circuit boards can discharge without detection. Although this product features patented or proprietary protection circuitry, damage may occur on devices subjected to high energy ESD. Therefore, proper ESD precautions should be taken to avoid performance degradation or loss of functionality.

PIN CONFIGURATION AND FUNCTION DESCRIPTIONS

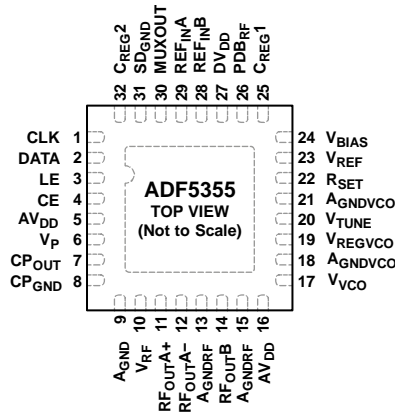

NOTES
 1. THE EXPOSED PAD MUST BE CONNECTED TO A_{GND}. 12714-003

Figure 3. Pin Configuration

Table 4. Pin Function Descriptions

| Pin No. | Mnemonic | Description |
|---------|---------------------|--|
| 1 | CLK | Serial Clock Input. Data is clocked into the 32-bit shift register on the CLK rising edge. This input is a high impedance CMOS input. |
| 2 | DATA | Serial Data Input. The serial data is loaded most significant bit (MSB) first with the four least significant bits (LSBs) as the control bits. This input is a high impedance CMOS input. |
| 3 | LE | Load Enable, CMOS Input. When LE goes high, the data stored in the shift register is loaded into the register that is selected by the four LSBs. |
| 4 | CE | Chip Enable. A logic low on this pin powers down the device and puts the charge pump into three-state mode. A logic high (at levels equal to DV _{DD}) on this pin powers up the device, depending on the status of the power-down bits. Register contents are retained unless the supply voltages are removed. |
| 5, 16 | AV _{DD} | Analog Power Supply. This pin ranges from 3.15 V to 3.45 V. Connect decoupling capacitors to the analog ground plane as close to this pin as possible. AV _{DD} must have the same value as DV _{DD} . |
| 6 | V _P | Charge Pump Power Supply. V _P must have the same value as V _{VCO} . Connect decoupling capacitors to the ground plane as close to this pin as possible. |
| 7 | CP _{OUT} | Charge Pump Output. When enabled, this output provides ±I _{CP} to the external loop filter. The output of the loop filter is connected to V _{TUNE} to drive the internal VCO. |
| 8 | CP _{GND} | Charge Pump Ground. This output is the ground return pin for CP _{OUT} . |
| 9 | A _{GND} | Analog Ground. Ground return pin for AV _{DD} . |
| 10 | V _{RF} | Power Supply for the RF Output. Connect decoupling capacitors to the analog ground plane as close to this pin as possible. V _{RF} must have the same value as AV _{DD} . Do not connect V _{RF} to DV _{DD} . |
| 11 | RF _{OUTA+} | VCO Output. The output level is programmable. The VCO fundamental output or a divided down version is available. This pin can be left floating if RF _{OUTA} is disabled in Register 6 or by the PDB _{RF} pin. |
| 12 | RF _{OUTA-} | Complementary VCO Output. The output level is programmable. The VCO fundamental output or a divided down version is available. This pin can be left floating if RF _{OUTA} is disabled in Register 6 or by the PDB _{RF} pin. |
| 13, 15 | A _{GNDRF} | RF Output Stage Ground. Ground return pins for the RF output stage. |
| 14 | RF _{OUTB} | Auxiliary VCO Output. The 2× VCO output is available at this pin. |
| 17 | V _{VCO} | Power Supply for the VCO. The voltage on this pin ranges from 4.75 V to 5.25 V. Place decoupling capacitors to the analog ground plane as close to this pin as possible. For best performance, this supply must be clean and have low noise. |
| 18, 21 | A _{GNDVCO} | VCO Ground. Ground return path for the VCO. |
| 19 | V _{REGVCO} | VCO Compensation Node. Place decoupling capacitors to the ground plane as close to this pin as possible. Connect this pin directly to V _{VCO} . |
| 20 | V _{TUNE} | Control Input to the VCO. This voltage determines the output frequency and is derived from filtering the CP _{OUT} output voltage. The input capacitance of this pin is 9 pF. |
| 22 | R _{SET} | No Connection. Charge pump bias resistance is internal. |

| Pin No. | Mnemonic | Description |
|---------|---------------------------------------|---|
| 23 | V _{REF} | Internal Compensation Node. DC biased at half the tuning range. Connect decoupling capacitors to the ground plane as close to this pin as possible. |
| 24 | V _{BIAS} | Reference Voltage. Connect a 100 nF decoupling capacitor to the ground plane as close to this pin as possible. |
| 25, 32 | C _{REG1} , C _{REG2} | Outputs from the LDO Regulator. Pin 25 and Pin 32 are the supply voltages to the digital circuits. Nominal voltage of 1.8 V. Decoupling capacitors of 100 nF connected to A _{GND} are required for these pins. |
| 26 | PDB _{RF} | RF _{OUTA} Power-Down. A logic low on this pin powers down the RF _{OUTA±} outputs only. This power-down function is also software controllable. Do not leave this pin floating. |
| 27 | DV _{DD} | Digital Power Supply. This pin must be at the same voltage as AV _{DD} . Do not connect to V _{RF} . Place decoupling capacitors to the ground plane as close to this pin as possible. |
| 28 | REF _{INB} | Complementary Reference Input. If unused, ac couple this pin to A _{GND} . |
| 29 | REF _{INA} | Reference Input. |
| 30 | MUXOUT | Multiplexer Output. The multiplexer output allows the digital lock detect, the analog lock detect, scaled RF, or the scaled reference frequency to be externally accessible. |
| 31 | SD _{GND} | Digital Σ - Δ Modulator Ground. Pin 31 is the ground return path for the Σ - Δ modulator. |
| | EPAD | Exposed Pad. The exposed pad must be connected to A _{GND} . |

TYPICAL PERFORMANCE CHARACTERISTICS

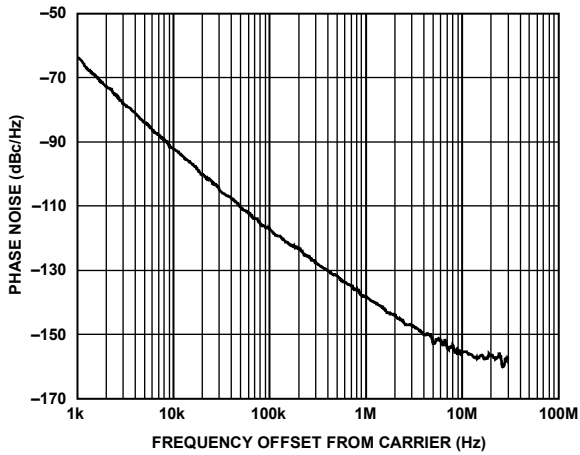

Figure 4. Open-Loop VCO Phase Noise, 3.4 GHz

12714-004

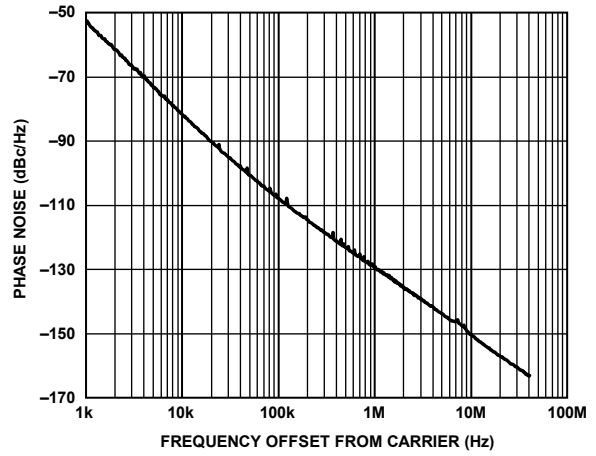

Figure 7. Open-Loop VCO Phase Noise, 8.0 GHz

12714-207

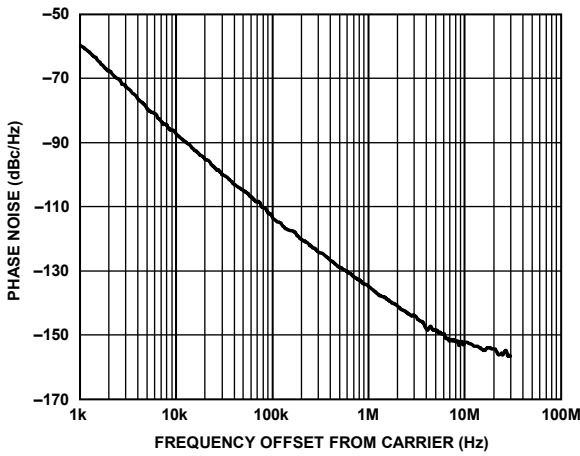

Figure 5. Open-Loop VCO Phase Noise, 5.0 GHz

12714-005

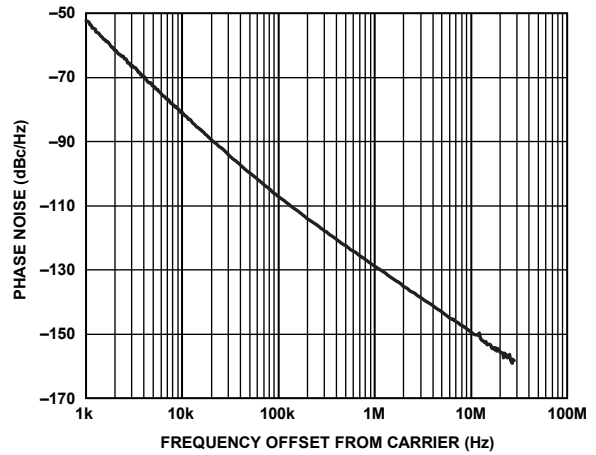

Figure 8. Open-Loop VCO Phase Noise, 10.0 GHz

12714-208

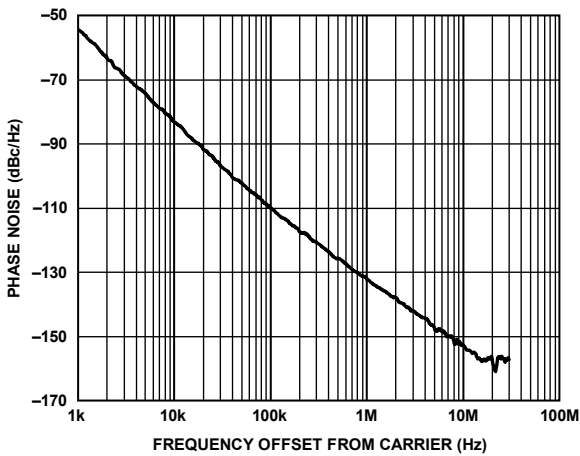

Figure 6. Open-Loop VCO Phase Noise, 6.8 GHz

12714-006

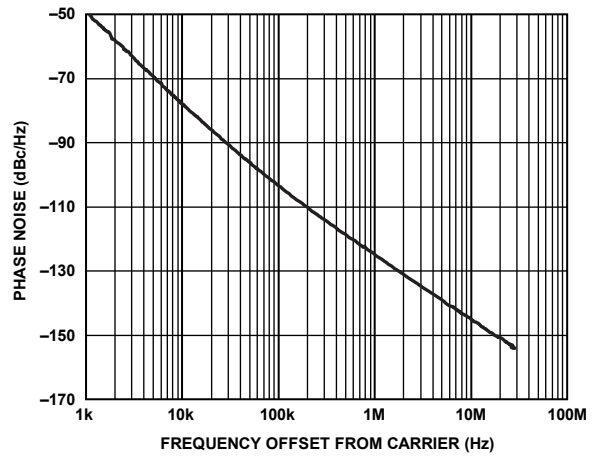

Figure 9. Open-Loop VCO Phase Noise, 13.6 GHz

12714-209

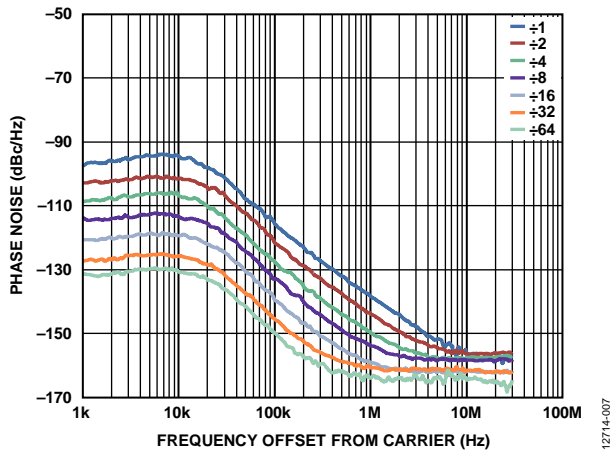

Figure 10. Closed-Loop Phase Noise, RF_{OUTA+} , Fundamental VCO and Dividers, VCO = 3.4 GHz, f_{PFD} = 61.44 MHz, Loop Bandwidth = 20 kHz

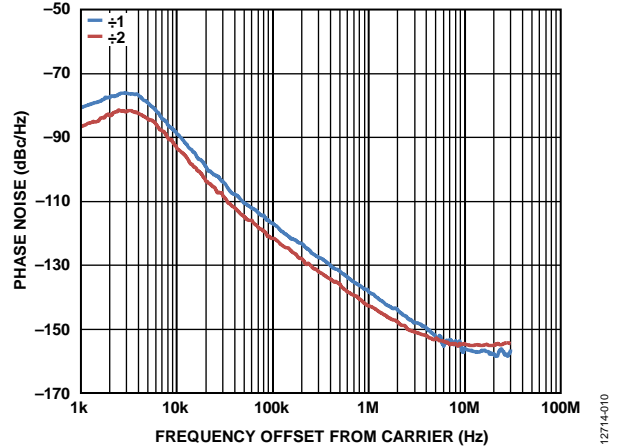

Figure 13. Closed-Loop Phase Noise, RF_{OUTA+} , Fundamental VCO and Divide by 2, VCO = 3.4 GHz, f_{PFD} = 61.44 MHz, Loop Bandwidth = 2 kHz

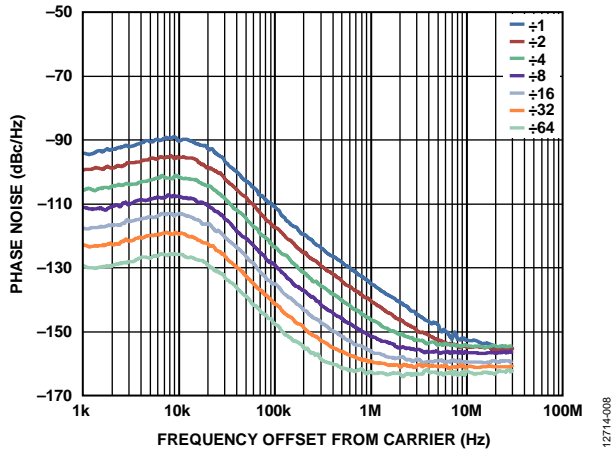

Figure 11. Closed-Loop Phase Noise, RF_{OUTA+} , Fundamental VCO and Dividers, VCO = 5.0 GHz, f_{PFD} = 61.44 MHz, Loop Bandwidth = 20 kHz

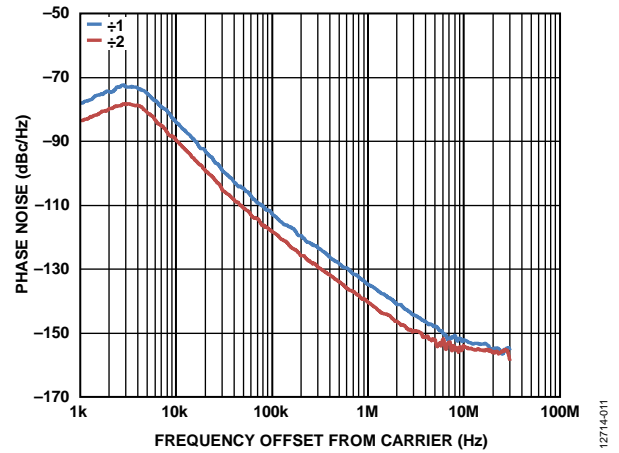

Figure 14. Closed-Loop Phase Noise, RF_{OUTA+} , Fundamental VCO and Divide by 2, VCO = 5.0 GHz, f_{PFD} = 61.44 MHz, Loop Bandwidth = 2 kHz

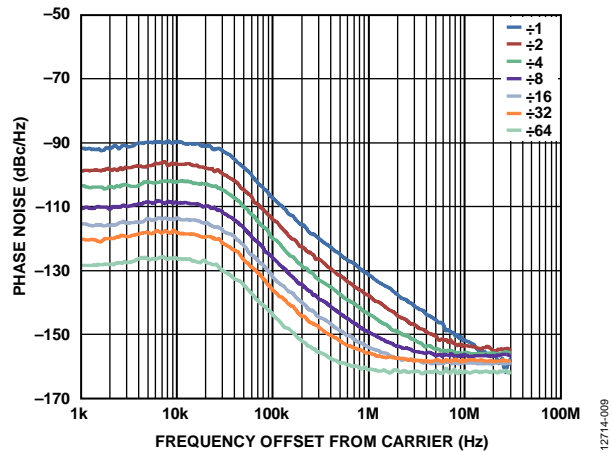

Figure 12. Closed-Loop Phase Noise, RF_{OUTA+} , Fundamental VCO and Dividers, VCO = 6.8 GHz, f_{PFD} = 61.44 MHz, Loop Bandwidth = 20 kHz

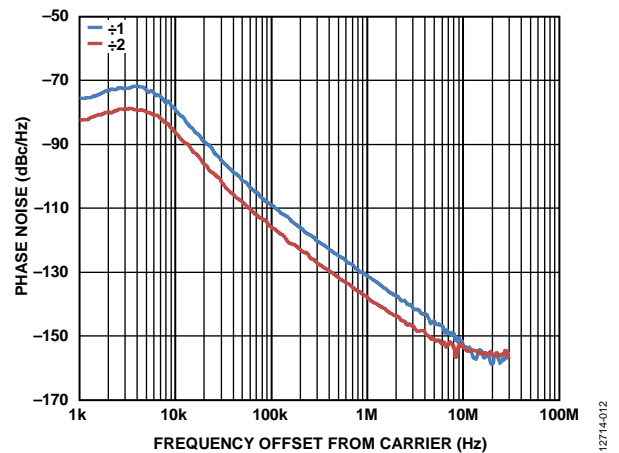

Figure 15. Closed-Loop Phase Noise, RF_{OUTA+} , Fundamental VCO and Divide by 2, VCO = 6.8 GHz, f_{PFD} = 61.44 MHz, Loop Bandwidth = 2 kHz

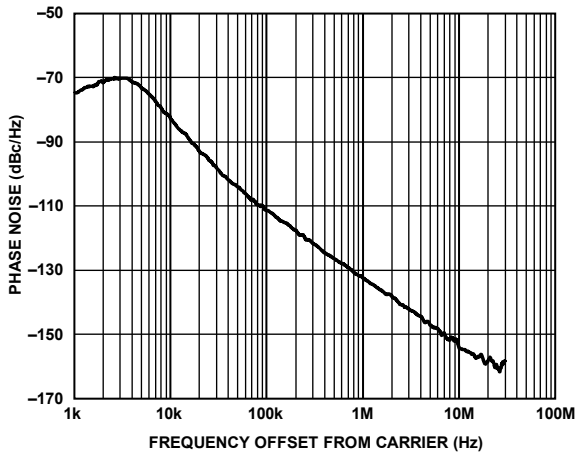

Figure 16. Closed-Loop Phase Noise, $R_{OUTB} = 6.8 \text{ GHz}$, $2 \times \text{VCO}$, $\text{VCO} = 3.4 \text{ GHz}$, $f_{\text{PFD}} = 61.44 \text{ MHz}$, Loop Bandwidth = 2 kHz

12714-013

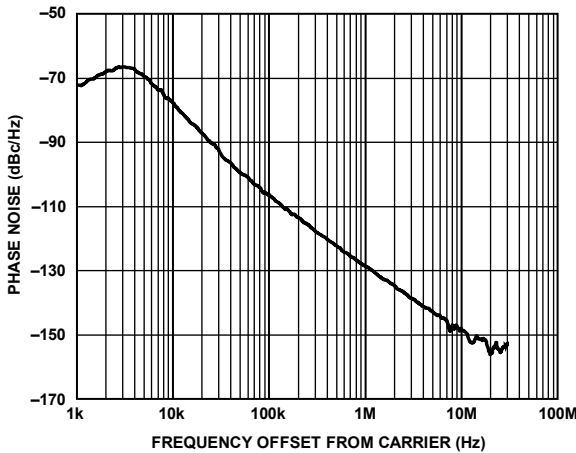

Figure 17. Closed-Loop Phase Noise, $R_{OUTB} = 10 \text{ GHz}$, $2 \times \text{VCO}$, $\text{VCO} = 5.0 \text{ GHz}$, $f_{\text{PFD}} = 61.44 \text{ MHz}$, Loop Bandwidth = 2 kHz

12714-014

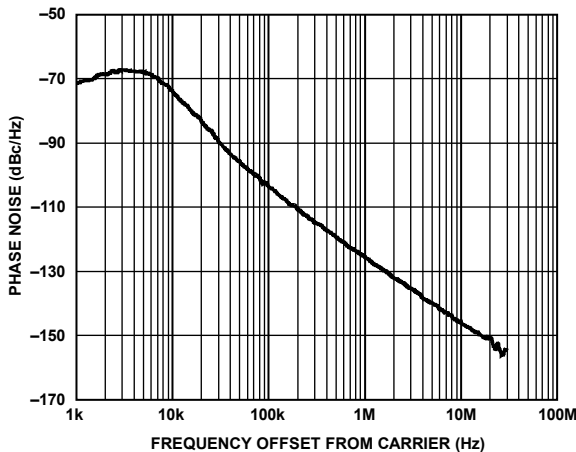

Figure 18. Closed-Loop Phase Noise, $R_{OUTB} = 13.6 \text{ GHz}$, $2 \times \text{VCO}$, $\text{VCO} = 6.8 \text{ GHz}$, $f_{\text{PFD}} = 61.44 \text{ MHz}$, Loop Bandwidth = 2 kHz

12714-015

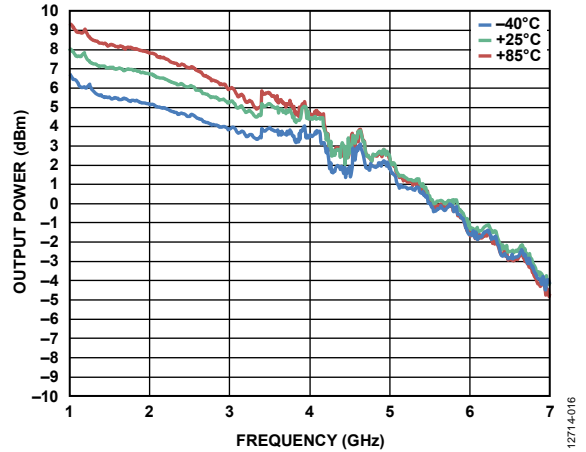

Figure 19. Output Power vs. Frequency, R_{OUTA+}/R_{OUTA-} (7.5 nH Inductors, 10 pF Bypass Capacitors, Board Losses De-Embedded)

12714-016

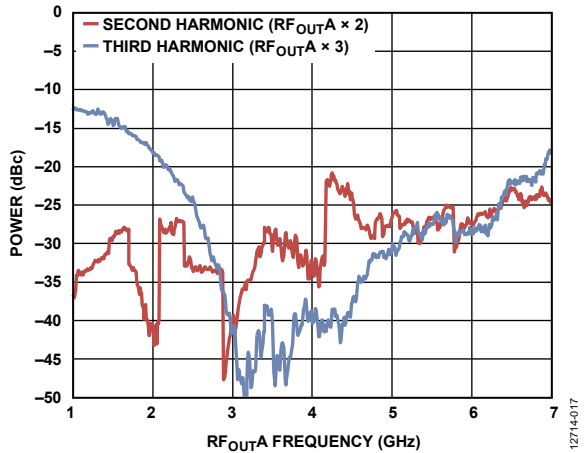

Figure 20. R_{OUTA+}/R_{OUTA-} Harmonics vs. Frequency (7.5 nH Inductors, 10 pF Bypass Capacitors, Board Losses De-Embedded)

12714-017

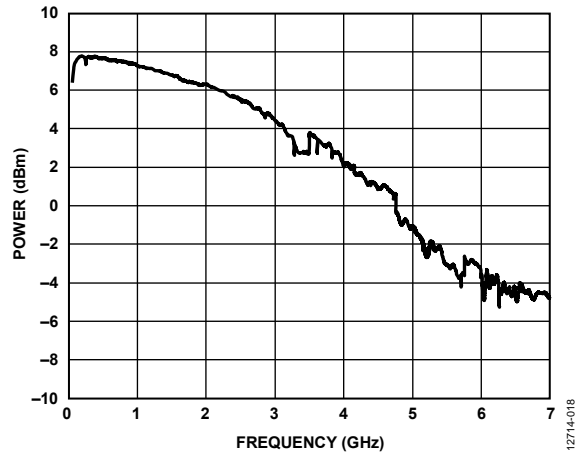

Figure 21. R_{OUTA+}/R_{OUTA-} Power vs. Frequency (100 nH Inductors, 100 pF Bypass Capacitors, Board Measurement)

12714-018

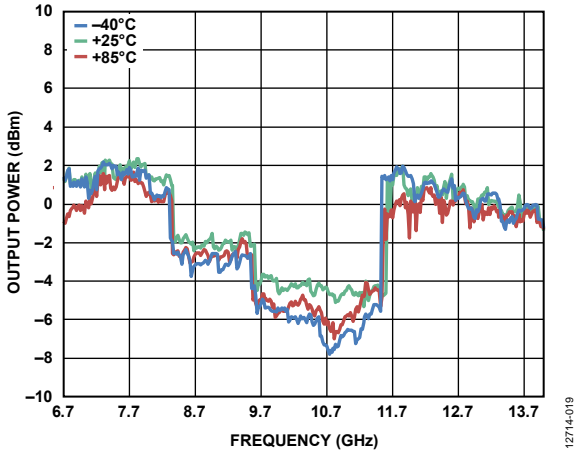

Figure 22. Output Power vs. Frequency, RF_{outB} (10 pF Bypass Capacitor De-Embedded)

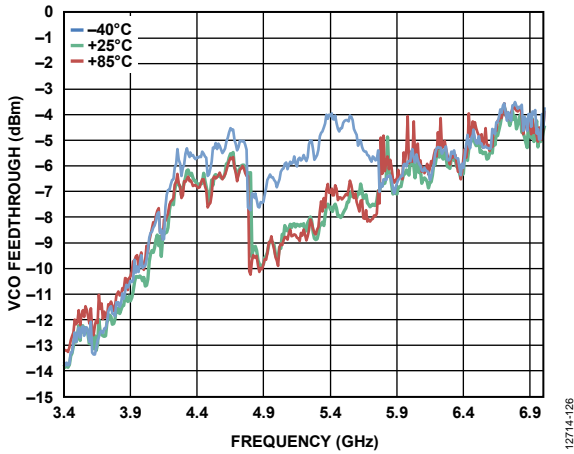

Figure 23. VCO Feedthrough at RF_{outB} (De-Embedded) vs. Fundamental VCO Frequency

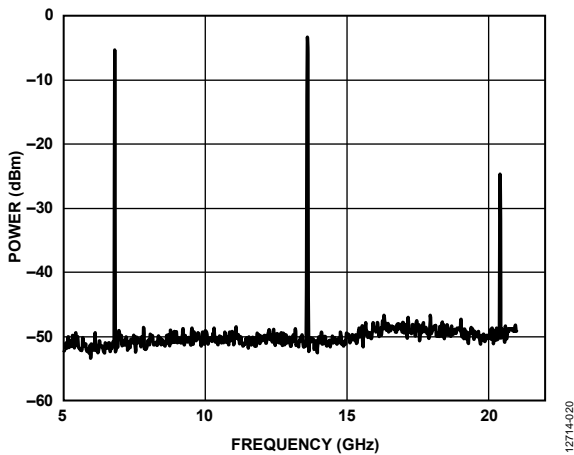

Figure 24. Wideband Spectrum, RF_{outB} , VCO = 6.8 GHz, RF_{outB} Enabled, RF_{outA+}/RF_{outA-} Disabled (Board Measurement)

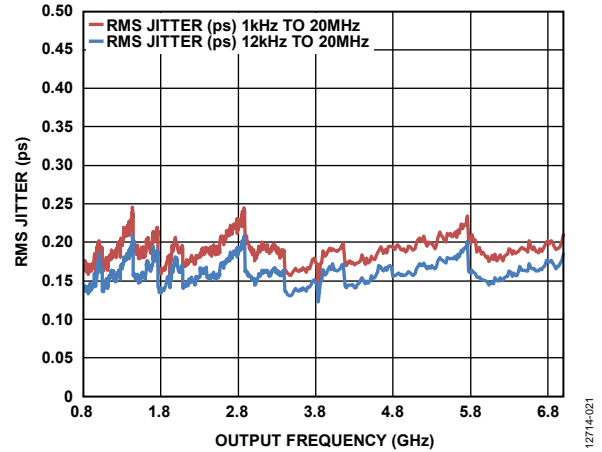

Figure 25. RMS Jitter vs. Output Frequency, $f_{PFD} = 61.44$ MHz, Loop Filter = 20 kHz

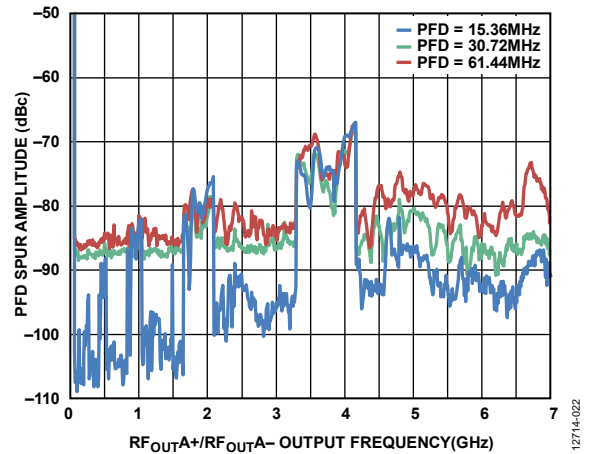

Figure 26. PFD Spur Amplitude vs. RF_{outA+}/RF_{outA-} Output Frequency; $f_{PFD} = 61.44$ MHz, $f_{PFD} = 30.72$ MHz, and $f_{PFD} = 15.36$ MHz; Loop Filter = 20 kHz

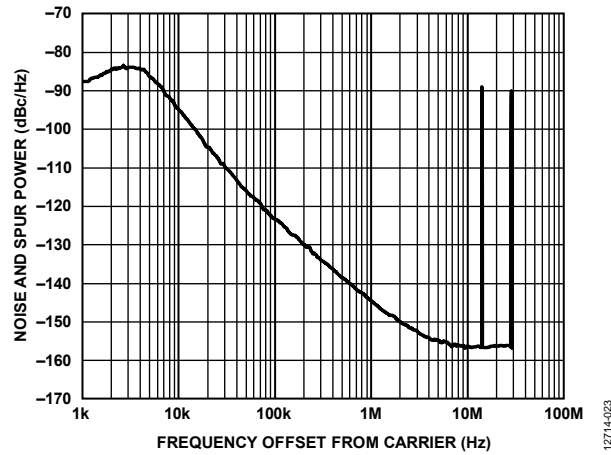

Figure 27. Fractional-N Spur Performance, GSM1800 Band, $RF_{outA+} = 1550.2$ MHz, $REF_{in} = 122.88$ MHz, $f_{PFD} = 61.44$ MHz, Output Divide by 4 Selected, Loop Filter Bandwidth = 2 kHz, Channel Spacing = 20 kHz

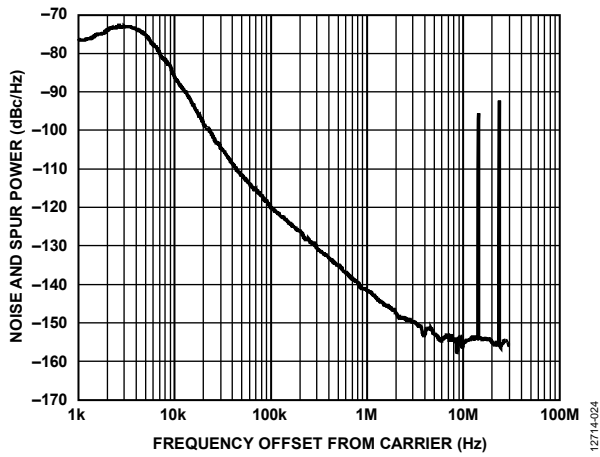

Figure 28. Fractional-N Spur Performance, W-CDMA Band, $R_{F_{OUTA+}} = 2113.5$ MHz, $R_{F_{IN}} = 122.88$ MHz, $f_{PFD} = 61.44$ MHz, Output Divide by 2 Selected, Loop Filter Bandwidth = 2 kHz, Channel Spacing = 20 kHz

12714-024

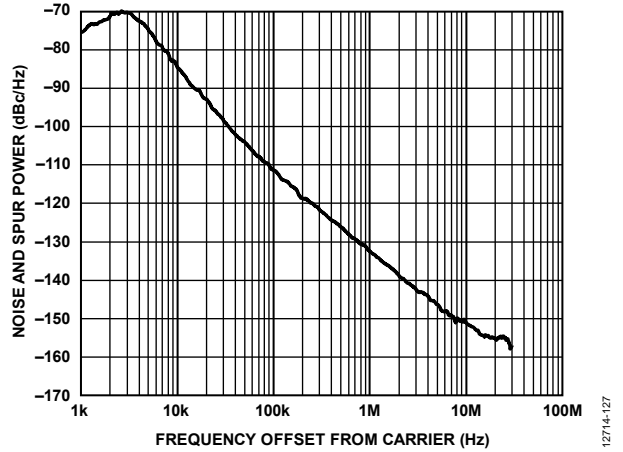

Figure 30. Fractional-N Spur Performance, $R_{F_{OUTA+}} = 5.8$ GHz, $R_{F_{IN}} = 122.88$ MHz, $f_{PFD} = 61.44$ MHz, Output Divide by 2 Selected, Loop Filter Bandwidth = 2 kHz, Channel Spacing = 20 kHz

12714-127

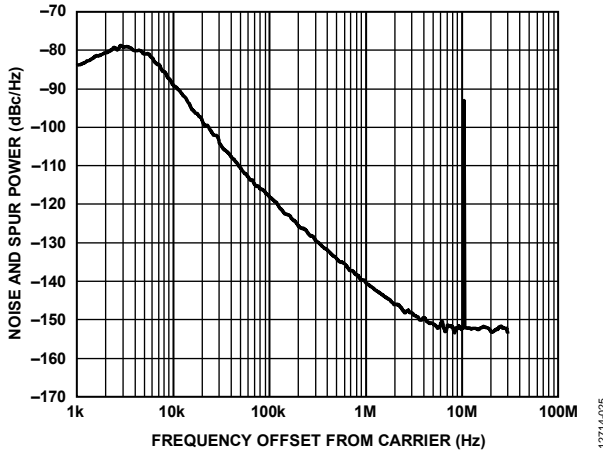

Figure 29. Fractional-N Spur Performance, $R_{F_{OUTA+}} = 2.591$ GHz, $R_{F_{IN}} = 122.88$ MHz, $f_{PFD} = 61.44$ MHz, Output Divide by 2 Selected, Loop Filter Bandwidth = 2 kHz, Channel Spacing = 20 kHz

12714-025

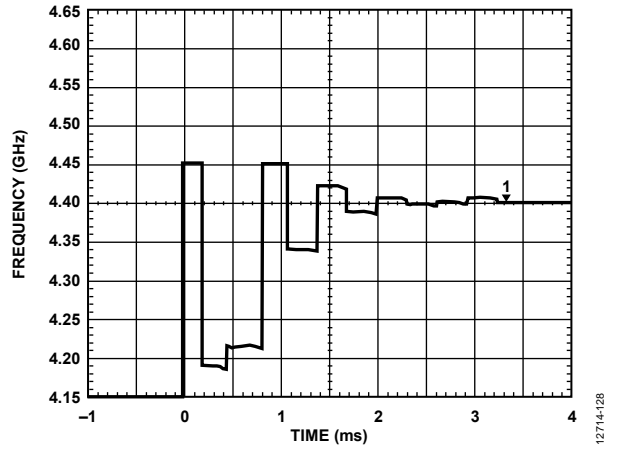

Figure 31. Lock Time for 250 MHz Jump from 4150 MHz to 4400 MHz, Loop Bandwidth = 20 kHz

12714-128

CIRCUIT DESCRIPTION

REFERENCE INPUT

Figure 32 shows the reference input stage. The reference input can accept both single-ended and differential signals. Use the reference mode bit (Register 4, DB9) to select the signal. To use a differential signal on the reference input, program this bit high. In this case, SW1 and SW2 are open, SW3 and SW4 are closed, and the current source that drives the differential pair of transistors switches on (see Figure 32). The differential signal is buffered, and it is provided to an emitter coupled logic (ECL) to CMOS converter. When a single-ended signal is used as the reference, connect the reference signal to REF_{INA} and program Bit DB9 in Register 4 to 0. In this case, SW1 and SW2 are closed, SW3 and SW4 are open, and the current source that drives the differential pair of transistors switches off. Single-ended mode results in lower integer boundary spurs.

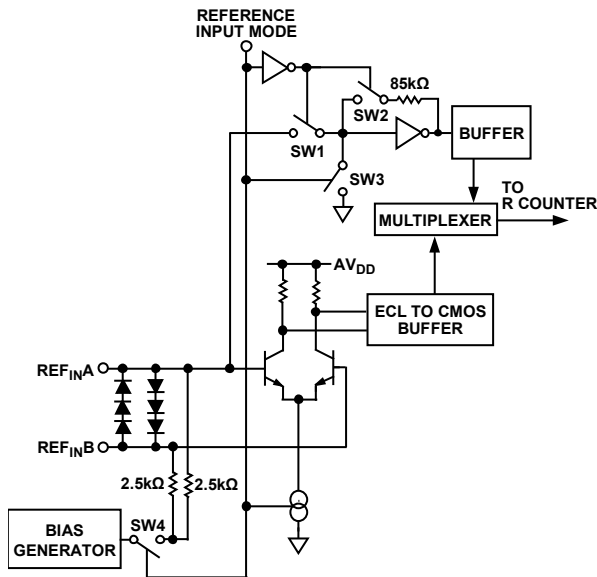

Figure 32. Reference Input Stage

RF N DIVIDER

The RF N divider allows a division ratio in the PLL feedback path. Determine the division ratio by the INT, FRAC1, FRAC2, and MOD2 values that this divider comprises.

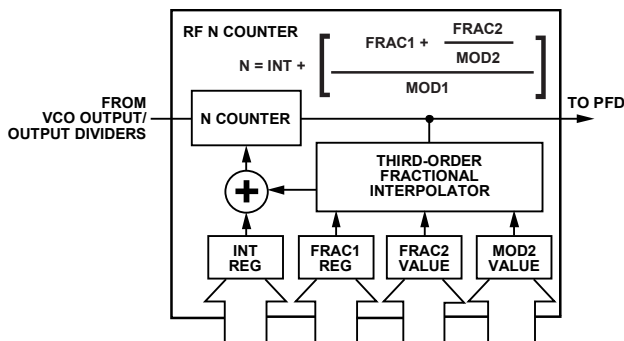

Figure 33. RF N Divider

INT, FRAC, MOD, and R Counter Relationship

The INT, FRAC1, FRAC2, MOD1, and MOD2 values, in conjunction with the R counter, make it possible to generate output frequencies that are spaced by fractions of the PFD frequency (f_{PFD}). For more information, see the RF Synthesizer—A Worked Example section.

Calculate the VCO output frequency (VCO_{OUT}) by

$$VCO_{OUT} = f_{PFD} \times N \tag{1}$$

where:

VCO_{OUT} is the output frequency of the external VCO voltage controlled oscillator (without using the output divider).

f_{PFD} is the frequency of the phase frequency detector.

N is the desired value of the feedback counter, N .

Calculate f_{PFD} by

$$f_{PFD} = REF_{IN} \times [(1 + D)/(R \times (1 + T))] \tag{2}$$

where:

REF_{IN} is the reference input frequency.

D is the REF_{IN} doubler bit.

R is the preset divide ratio of the binary 10-bit programmable reference counter (1 to 1023).

T is the REF_{IN} divide by 2 bit (0 or 1)

N comprises

$$N = INT + \frac{FRAC1 + \frac{FRAC2}{MOD2}}{MOD1} \tag{3}$$

where:

INT is the 16-bit integer value (23 to 32,767 for 4/5 prescaler, 75 to 65,535 for 8/9 prescaler).

$FRAC1$ is the numerator of the primary modulus (0 to 16,777,215). $FRAC2$ is the numerator of the 14-bit auxiliary modulus (0 to 16,383).

$MOD2$ is the programmable, 14-bit auxiliary fractional modulus (2 to 16,383).

$MOD1$ is a 24-bit primary modulus with a fixed value of $2^{24} = 16,777,216$.

This calculation results in a very fine frequency resolution with no residual frequency error. To apply this formula, take the following steps:

1. Calculate N by dividing VCO_{OUT}/f_{PFD} .
2. The integer value of this number forms INT .
3. Subtract this value from the full N value.
4. Multiply the remainder by 2^{24} .
5. The integer value of this number forms $FRAC1$.
6. Calculate $MOD2$ based on the channel spacing (f_{CHSP}) by

$$MOD2 = f_{PFD}/GCD(f_{PFD}, f_{CHSP}) \tag{4}$$

where:

f_{CHSP} is the desired channel spacing frequency.

$GCD(f_{PFD}, f_{CHSP})$ is the greatest common divisor of the PFD frequency and the channel spacing frequency.

7. Calculate FRAC2 by the following equation:

$$FRAC2 = [(N - INT) \times 2^{24} - FRAC1] \times MOD2 \quad (5)$$

The FRAC2 and MOD2 fraction result in outputs with zero frequency error for channel spacings when

$$f_{PFD}/GCD(f_{PFD}, f_{CHSP}) = MOD2 < 16,383 \quad (6)$$

where:

f_{PFD} is the frequency of the phase frequency detector.

f_{CHSP} is the desired channel spacing.

GCD is a greatest common divisor function.

If zero frequency error is not required, the MOD1 and MOD2 denominators operate together to create a 38-bit resolution modulus.

INT N Mode

When FRAC1 and FRAC2 are 0, the synthesizer operates in integer-N mode.

R Counter

The 10-bit R counter allows the input reference frequency (REF_{IN}) to be divided down to produce the reference clock to the PFD. Division ratios from 1 to 1023 are allowed.

PHASE FREQUENCY DETECTOR (PFD) AND CHARGE PUMP

The PFD takes inputs from the R counter and N counter and produces an output proportional to the phase and frequency difference between them. Figure 34 is a simplified schematic of the phase frequency detector. The PFD includes a fixed delay element ($INT = 1.6$ ns, $FRAC = 2.6$ ns) that sets the width of the anti-backlash pulse. This pulse ensures that there is no dead zone in the PFD transfer function and provides a consistent reference spur level. Set the phase detector polarity to positive on this device because of the positive tuning of the VCO.

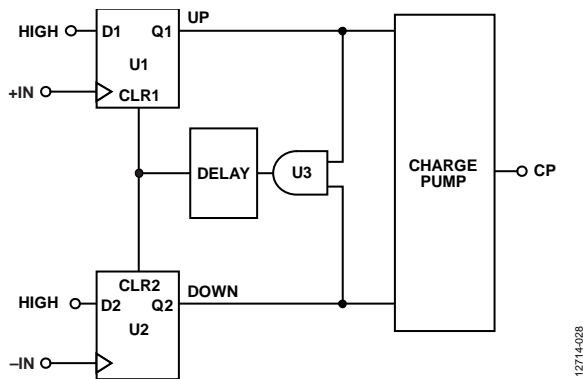

Figure 34. PFD Simplified Schematic

MUXOUT AND LOCK DETECT

The output multiplexer on the ADF5355 allows the user to access various internal points on the chip. The M3, M2, and M1 bits in Register 4 control the state of MUXOUT. Figure 35 shows the MUXOUT section in block diagram form.

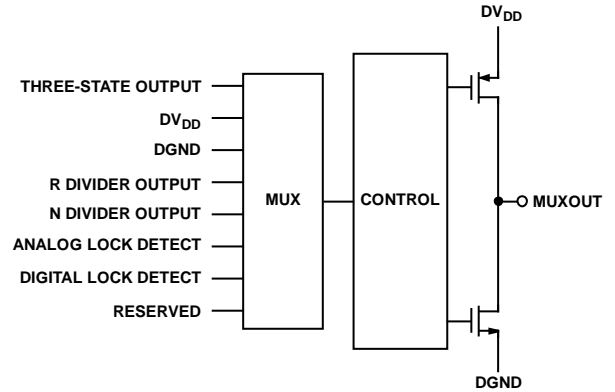

Figure 35. MUXOUT Schematic

INPUT SHIFT REGISTERS

The ADF5355 digital section includes a 10-bit R counter, a 16-bit RF integer-N counter, a 24-bit FRAC1 counter, a 14-bit auxiliary fractional counter, and a 14-bit auxiliary modulus counter. Data clocks into the 32-bit shift register on each rising edge of CLK. The data clocks in MSB first. Data transfers from the shift register to one of 13 latches on the rising edge of LE. The state of the four control bits (C4, C3, C2, and C1) in the shift register determines the destination latch. As shown in Figure 2, the four LSBs are DB3, DB2, DB1, and DB0. The truth table for these bits is shown in Table 5. Figure 39 and Figure 40 summarize the programming of the latches.

Table 5. Truth Table for the C4, C3, C2, and C1 Control Bits

| Control Bits | | | | Register |
|--------------|----|----|----|-------------|
| C4 | C3 | C2 | C1 | |
| 0 | 0 | 0 | 0 | Register 0 |
| 0 | 0 | 0 | 1 | Register 1 |
| 0 | 0 | 1 | 0 | Register 2 |
| 0 | 0 | 1 | 1 | Register 3 |
| 0 | 1 | 0 | 0 | Register 4 |
| 0 | 1 | 0 | 1 | Register 5 |
| 0 | 1 | 1 | 0 | Register 6 |
| 0 | 1 | 1 | 1 | Register 7 |
| 1 | 0 | 0 | 0 | Register 8 |
| 1 | 0 | 0 | 1 | Register 9 |
| 1 | 0 | 1 | 0 | Register 10 |
| 1 | 0 | 1 | 1 | Register 11 |
| 1 | 1 | 0 | 0 | Register 12 |

PROGRAM MODES

Table 5 and Figure 39 through Figure 53 show how the program modes must be set up in the ADF5355.

The following settings in the ADF5355 are double buffered: main fractional value (FRAC1), auxiliary modulus value (MOD2), auxiliary fractional value (FRAC2), reference doubler, reference divide by 2 (RDIV2), R counter value, and charge pump current setting. Two events must occur before the ADF5355 uses a new value for any of the double buffered settings. First, the new value must latch into the device by writing to the appropriate register, and second, a new write to Register 0 must be performed.

For example, to ensure that the modulus value loads correctly, every time that the modulus value updates, Register 0 must be written to. The RF divider select in Register 6 is also double buffered, but only if DB14 of Register 4 is high.

VCO

The VCO core in the ADF5355 consists of four separate VCOs, each of which uses 256 overlapping bands, which allows the device to cover a wide frequency range without large VCO sensitivity (K_V) and without resultant poor phase noise and spurious performance.

The correct VCO and band are chosen automatically by the VCO and band select logic whenever Register 0 is updated and automatic calibration is enabled. The VCO V_{TUNE} is disconnected from the output of the loop filter and is connected to an internal reference voltage.

The R counter output is used as the clock for the band select logic. After band selection, normal PLL action resumes. The nominal value of K_V is 15 MHz/V when the N divider is driven from the VCO output, or the K_V value is divided by D. D is the output divider value if the N divider is driven from the RF output divider (chosen by programming Bits[D23:D21] in Register 6).

The VCO shows variation of K_V as the tuning voltage, V_{TUNE} , varies within the band and from band to band. For wideband applications covering a wide frequency range (and changing output dividers), a value of 15 MHz/V provides the most accurate K_V , because this value is closest to the average value. Figure 36 shows how K_V varies with fundamental VCO frequency along with an average value for the frequency band. Users may prefer this figure when using narrow-band designs.

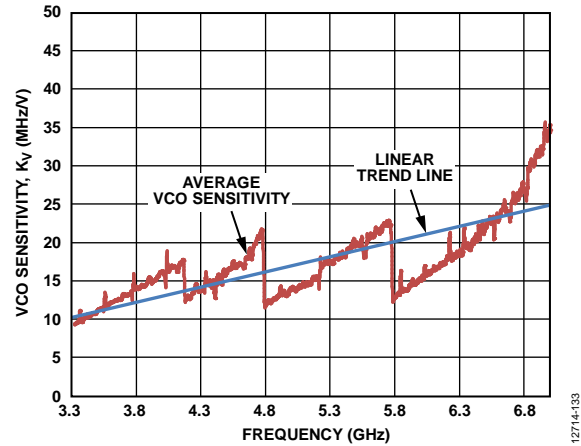

Figure 36. VCO Sensitivity, K_V vs. Frequency

OUTPUT STAGE

The RF_{OUTA+} and RF_{OUTA-} pins of the ADF5355 connect to the collectors of an NPN differential pair driven by buffered outputs of the VCO, as shown in Figure 37. In this scheme, the ADF5355 contains internal 50 Ω resistors connected to the V_{RF} pin. To optimize the power dissipation vs. the output power requirements, the tail current of the differential pair is programmable using Bits[D2:D1] in Register 6. Four current levels can be set. These levels give approximate output power levels of -4 dBm, -1 dBm, +2 dBm, and +5 dBm, respectively. Levels of -4 dBm, -1 dBm, +2 dBm can be achieved using a 50 Ω resistor to V_{RF} and ac coupling into a 50 Ω load. A +5 dBm level requires an external shunt inductor to V_{RF} . Note that an inductor has a narrower operating frequency than a 50 Ω resistor. For accurate power levels, refer to the Typical Performance Characteristics section. Add an external shunt inductor to provide higher power levels; however, this is less wideband than the internal bias only. Terminate the unused complementary output with a circuit similar to the used output.

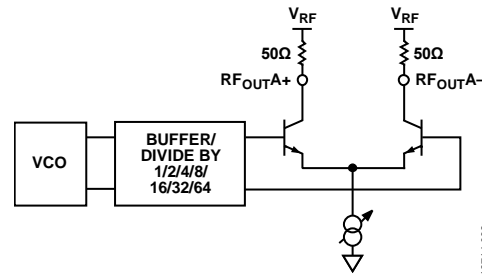

Figure 37. Output Stage

The doubled VCO output (6.8 GHz to 13.6 GHz) is available on the RF_{OUTB} pin, which can be ac-coupled to the next circuit.

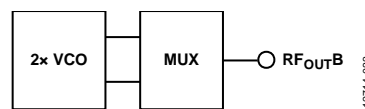

Figure 38. Output Stage

Another feature of the ADF5355 is that the supply current to the RF_{OUTA+}/RF_{OUTA-} output stage can shut down until the ADF5355 achieves lock as measured by the digital lock detect circuitry. The mute till lock detect (MTLD) bit (Bit DB11) in Register 6 enables this function.

RF_{OUTB} directly connects to the VCO, and it can be muted but only by using the RF_{OUTB} bit (Bit DB10) in Register 6.

Table 6. Total I_{DD} (RF_{OUTA±} Refers to RF_{OUTA+}/RF_{OUTA-})

| Divide By | RF _{OUTA±} Off | RF _{OUTA±} = -4 dBm | RF _{OUTA±} = -1 dBm | RF _{OUTA±} = +2 dBm | RF _{OUTA±} = +5 dBm |
|--|-------------------------|------------------------------|------------------------------|------------------------------|------------------------------|
| 5.0 V Supply (I _{VCO} and I _P) | 78 mA | 78 mA | 78 mA | 78 mA | 78 mA |
| 3.3 V Supply (AI _{DD} , DI _{DD} , I _{RF}) ¹ | | | | | |
| 1 | 79.8 mA | 101.3 mA | 111.9 mA | 122.7 mA | 132.8 mA |
| 2 | 87.8 mA | 110.1 mA | 120.6 mA | 131.9 mA | 141.9 mA |
| 4 | 97.1 mA | 119.3 mA | 130.1 mA | 141.6 mA | 152.1 mA |
| 8 | 104.9 mA | 127.1 mA | 137.8 mA | 149.2 mA | 159.7 mA |
| 16 | 109.8 mA | 131.8 mA | 142.7 mA | 154.1 mA | 164.6 mA |
| 32 | 113.6 mA | 135.5 mA | 146.5 mA | 157.8 mA | 168.4 mA |
| 64 | 115.9 mA | 137.8 mA | 148.9 mA | 160.1 mA | 170.8 mA |

¹ For DI_{DD} + AI_{DD} (nominal 62 mA): DI_{DD} = 15 mA (typical), AI_{DD} (Pin 5) = 24 mA (typical), AI_{DD} (Pin 16) = 23 mA (typical).

REGISTER MAPS

REGISTER 0

| | | | | | | | | | | | | | | | | | | | | | | | | | | | | | | | | |
|----------|------|------|------|------|------|------|------|------|------|------|---------|-----------|----------------------------|------|------|------|------|------|------|------|------|-----|-----|-----|-----|-----|-----|-----|--------------|-------|-------|-------|
| RESERVED | | | | | | | | | | | AUTOCAL | PRESCALER | 16-BIT INTEGER VALUE (INT) | | | | | | | | | | | | | | | | CONTROL BITS | | | |
| DB31 | DB30 | DB29 | DB28 | DB27 | DB26 | DB25 | DB24 | DB23 | DB22 | DB21 | DB20 | DB19 | DB18 | DB17 | DB16 | DB15 | DB14 | DB13 | DB12 | DB11 | DB10 | DB9 | DB8 | DB7 | DB6 | DB5 | DB4 | DB3 | DB2 | DB1 | DB0 | |
| 0 | 0 | 0 | 0 | 0 | 0 | 0 | 0 | 0 | 0 | 0 | AC1 | PR1 | N16 | N15 | N14 | N13 | N12 | N11 | N10 | N9 | N8 | N7 | N6 | N5 | N4 | N3 | N2 | N1 | C4(0) | C3(0) | C2(0) | C1(0) |

REGISTER 1

| | | | | | | | | | | | | | | | | | | | | | | | | | | | | | | | |
|----------|------|------|------|---|------|------|------|------|------|------|------|------|------|------|------|------|------|------|------|------|------|-----|-----|-----|-----|-----|-----|--------------|-------|-------|-------|
| RESERVED | | | | 24-BIT MAIN FRACTIONAL VALUE (FRAC1) DBR ¹ | | | | | | | | | | | | | | | | | | | | | | | | CONTROL BITS | | | |
| DB31 | DB30 | DB29 | DB28 | DB27 | DB26 | DB25 | DB24 | DB23 | DB22 | DB21 | DB20 | DB19 | DB18 | DB17 | DB16 | DB15 | DB14 | DB13 | DB12 | DB11 | DB10 | DB9 | DB8 | DB7 | DB6 | DB5 | DB4 | DB3 | DB2 | DB1 | DB0 |
| 0 | 0 | 0 | 0 | F24 | F23 | F22 | F21 | F20 | F19 | F18 | F17 | F16 | F15 | F14 | F13 | F12 | F11 | F10 | F9 | F8 | F7 | F6 | F5 | F4 | F3 | F2 | F1 | C4(0) | C3(0) | C2(0) | C1(1) |

REGISTER 2

| | | | | | | | | | | | | | | | | | | | | | | | | | | | | | | | |
|--|------|------|------|------|------|------|------|------|------|------|------|------|------|--|------|------|------|------|------|------|------|-----|-----|-----|-----|-----|-----|--------------|-------|-------|-------|
| 14-BIT AUXILIARY FRACTIONAL VALUE (FRAC2) DBR ¹ | | | | | | | | | | | | | | 14-BIT AUXILIARY MODULUS VALUE (MOD2) DBR ¹ | | | | | | | | | | | | | | CONTROL BITS | | | |
| DB31 | DB30 | DB29 | DB28 | DB27 | DB26 | DB25 | DB24 | DB23 | DB22 | DB21 | DB20 | DB19 | DB18 | DB17 | DB16 | DB15 | DB14 | DB13 | DB12 | DB11 | DB10 | DB9 | DB8 | DB7 | DB6 | DB5 | DB4 | DB3 | DB2 | DB1 | DB0 |
| F14 | F13 | F12 | F11 | F10 | F9 | F8 | F7 | F6 | F5 | F4 | F3 | F2 | F1 | M14 | M13 | M12 | M11 | M10 | M9 | M8 | M7 | M6 | M5 | M4 | M3 | M2 | M1 | C4(0) | C3(0) | C2(1) | C1(0) |

REGISTER 3

| | | | | | | | | | | | | | | | | | | | | | | | | | | | | | | | |
|----------|---------------|--------------|--------------|---|------|------|------|------|------|------|------|------|------|------|------|------|------|------|------|------|------|-----|-----|-----|-----|-----|-----|--------------|-------|-------|-------|
| RESERVED | SD_LOAD RESET | PHASE RESYNC | PHASE ADJUST | 24-BIT PHASE VALUE (PHASE) DBR ¹ | | | | | | | | | | | | | | | | | | | | | | | | CONTROL BITS | | | |
| DB31 | DB30 | DB29 | DB28 | DB27 | DB26 | DB25 | DB24 | DB23 | DB22 | DB21 | DB20 | DB19 | DB18 | DB17 | DB16 | DB15 | DB14 | DB13 | DB12 | DB11 | DB10 | DB9 | DB8 | DB7 | DB6 | DB5 | DB4 | DB3 | DB2 | DB1 | DB0 |
| 0 | SD1 | PR1 | PA1 | P24 | P23 | P22 | P21 | P20 | P19 | P18 | P17 | P16 | P15 | P14 | P13 | P12 | P11 | P10 | P9 | P8 | P7 | P6 | P5 | P4 | P3 | P2 | P1 | C4(0) | C3(0) | C2(1) | C1(1) |

REGISTER 4

| | | | | | | | | | | | | | | | | | | | | | | | | | | | | | | | |
|----------|--------|------|------|------------------------------------|------------------------|-----------------------------------|------|------|------|------|------|------|------|------|------|-------------|----------------------------------|------|------|------|----------|-----------|-------------|-----|----------------|---------------|--------------|-------|-------|-------|-------|
| RESERVED | MUXOUT | | | REFERENCE DOUBLER DBR ¹ | RDIV2 DBR ¹ | 10-BIT R COUNTER DBR ¹ | | | | | | | | | | DOUBLE BUFF | CURRENT SETTING DBR ¹ | | | | REF MODE | MUX LOGIC | PD POLARITY | PD | CP THREE-STATE | COUNTER RESET | CONTROL BITS | | | | |
| DB31 | DB30 | DB29 | DB28 | DB27 | DB26 | DB25 | DB24 | DB23 | DB22 | DB21 | DB20 | DB19 | DB18 | DB17 | DB16 | DB15 | DB14 | DB13 | DB12 | DB11 | DB10 | DB9 | DB8 | DB7 | DB6 | DB5 | DB4 | DB3 | DB2 | DB1 | DB0 |
| 0 | 0 | M3 | M2 | M1 | RD2 | RD1 | R10 | R9 | R8 | R7 | R6 | R5 | R4 | R3 | R2 | R1 | D1 | CP4 | CP3 | CP2 | CP1 | U6 | U5 | U4 | U3 | U2 | U1 | C4(0) | C3(1) | C2(0) | C1(0) |

REGISTER 5

| | | | | | | | | | | | | | | | | | | | | | | | | | | | | | | | | |
|----------|------|------|------|------|------|------|------|------|------|------|------|------|------|------|------|------|------|------|------|------|------|-----|-----|-----|-----|-----|-----|--------------|-------|-------|-------|-------|
| RESERVED | | | | | | | | | | | | | | | | | | | | | | | | | | | | CONTROL BITS | | | | |
| DB31 | DB30 | DB29 | DB28 | DB27 | DB26 | DB25 | DB24 | DB23 | DB22 | DB21 | DB20 | DB19 | DB18 | DB17 | DB16 | DB15 | DB14 | DB13 | DB12 | DB11 | DB10 | DB9 | DB8 | DB7 | DB6 | DB5 | DB4 | DB3 | DB2 | DB1 | DB0 | |
| 0 | 0 | 0 | 0 | 0 | 0 | 0 | 0 | 1 | 0 | 0 | 0 | 0 | 0 | 0 | 0 | 0 | 0 | 0 | 0 | 0 | 0 | 0 | 0 | 0 | 0 | 0 | 1 | 0 | C4(0) | C3(1) | C2(0) | C1(1) |

REGISTER 6

| | | | | | | | | | | | | | | | | | | | | | | | | | | | | | | | |
|----------|-------------|----------------|----------|------|------|------|-----------------|--------------------------------|------|---------------------------|------|------|------|------|------|------|------|----------|------|----------|----------|-----|-----|---------------------|-----------------|--------------|-----|-------|-------|-------|-------|
| RESERVED | GATED BLEED | NEGATIVE BLEED | RESERVED | | | | FEEDBACK SELECT | RF DIVIDER SELECT ² | | CHARGE PUMP BLEED CURRENT | | | | | | | | RESERVED | MTLD | RF OUT B | RESERVED | | | RF OUT A+ RF OUT A- | RF OUTPUT POWER | CONTROL BITS | | | | | |
| DB31 | DB30 | DB29 | DB28 | DB27 | DB26 | DB25 | DB24 | DB23 | DB22 | DB21 | DB20 | DB19 | DB18 | DB17 | DB16 | DB15 | DB14 | DB13 | DB12 | DB11 | DB10 | DB9 | DB8 | DB7 | DB6 | DB5 | DB4 | DB3 | DB2 | DB1 | DB0 |
| 0 | BL10 | BL9 | 1 | 0 | 1 | 0 | D13 | D12 | D11 | D10 | BL8 | BL7 | BL6 | BL5 | BL4 | BL3 | BL2 | BL1 | 0 | D8 | D7 | 0 | 0 | 0 | D3 | D2 | D1 | C4(0) | C3(1) | C2(1) | C1(0) |

¹DBR = DOUBLE BUFFERED REGISTER—BUFFERED BY THE WRITE TO REGISTER 0.
²DBB = DOUBLE BUFFERED BITS—BUFFERED BY A WRITE TO REGISTER 0 WHEN BIT DB14 OF REGISTER 4 IS HIGH.

Figure 39. Register Summary (Register 0 to Register 6)

REGISTER 7

| RESERVED | | | | | | | | | | | | | | | | LE SYNC | RESERVED | | | | | | | | | | | | | | | | LD CYCLE COUNT | LOL MODE | FRAC-N LD PRECISION | LD MODE | CONTROL BITS | | | |
|----------|------|------|------|------|------|------|------|------|------|------|------|------|------|------|------|---------|----------|------|------|------|------|-----|-----|-----|-----|-----|-----|-----|-------|-------|-------|-------|----------------|----------|---------------------|---------|--------------|--|--|--|
| DB31 | DB30 | DB29 | DB28 | DB27 | DB26 | DB25 | DB24 | DB23 | DB22 | DB21 | DB20 | DB19 | DB18 | DB17 | DB16 | DB15 | DB14 | DB13 | DB12 | DB11 | DB10 | DB9 | DB8 | DB7 | DB6 | DB5 | DB4 | DB3 | DB2 | DB1 | DB0 | | | | | | | | | |
| 0 | 0 | 0 | 1 | 0 | 0 | LE | 0 | 0 | 0 | 0 | 0 | 0 | 0 | 0 | 0 | 0 | 0 | 0 | 0 | 0 | 0 | 0 | LD5 | LD4 | LOL | LD3 | LD2 | LD1 | C4(0) | C3(1) | C2(1) | C1(1) | | | | | | | | |

REGISTER 8

| RESERVED | | | | | | | | | | | | | | | | | | | | | | | | | | | | CONTROL BITS | | | | |
|----------|------|------|------|------|------|------|------|------|------|------|------|------|------|------|------|------|------|------|------|------|------|-----|-----|-----|-----|-----|-----|--------------|-------|-------|-------|-------|
| DB31 | DB30 | DB29 | DB28 | DB27 | DB26 | DB25 | DB24 | DB23 | DB22 | DB21 | DB20 | DB19 | DB18 | DB17 | DB16 | DB15 | DB14 | DB13 | DB12 | DB11 | DB10 | DB9 | DB8 | DB7 | DB6 | DB5 | DB4 | DB3 | DB2 | DB1 | DB0 | |
| 0 | 0 | 0 | 1 | 0 | 0 | 0 | 0 | 0 | 0 | 1 | 0 | 1 | 1 | 0 | 1 | 0 | 0 | 0 | 0 | 0 | 0 | 1 | 0 | 0 | 0 | 0 | 1 | 0 | C4(1) | C3(0) | C2(0) | C1(0) |

REGISTER 9

| VCO BAND DIVISION | | | | | | TIMEOUT | | | | | | | | AUTOMATIC LEVEL TIMEOUT | | | | | SYNTHESIZER LOCK TIMEOUT | | | | CONTROL BITS | | | | | | | | |
|-------------------|------|------|------|------|------|---------|------|------|------|------|------|------|------|-------------------------|------|------|------|------|--------------------------|------|------|-----|--------------|-----|-----|-----|-----|-------|-------|-------|-------|
| DB31 | DB30 | DB29 | DB28 | DB27 | DB26 | DB25 | DB24 | DB23 | DB22 | DB21 | DB20 | DB19 | DB18 | DB17 | DB16 | DB15 | DB14 | DB13 | DB12 | DB11 | DB10 | DB9 | DB8 | DB7 | DB6 | DB5 | DB4 | DB3 | DB2 | DB1 | DB0 |
| VC8 | VC7 | VC6 | VC5 | VC4 | VC3 | VC2 | VC1 | TL10 | TL9 | TL8 | TL7 | TL6 | TL5 | TL4 | TL3 | TL2 | TL1 | AL5 | AL4 | AL3 | AL2 | AL1 | SL5 | SL4 | SL3 | SL2 | SL1 | C4(1) | C3(0) | C2(0) | C1(1) |

REGISTER 10

| RESERVED | | | | | | | | | | | | | | | | ADC CLOCK DIVIDER | | | | | | | | ADC CONVERSION | ADC ENABLE | CONTROL BITS | | | | | |
|----------|------|------|------|------|------|------|------|------|------|------|------|------|------|------|------|-------------------|------|------|------|------|------|-----|-----|----------------|------------|--------------|-----|-------|-------|-------|-------|
| DB31 | DB30 | DB29 | DB28 | DB27 | DB26 | DB25 | DB24 | DB23 | DB22 | DB21 | DB20 | DB19 | DB18 | DB17 | DB16 | DB15 | DB14 | DB13 | DB12 | DB11 | DB10 | DB9 | DB8 | DB7 | DB6 | DB5 | DB4 | DB3 | DB2 | DB1 | DB0 |
| 0 | 0 | 0 | 0 | 0 | 0 | 0 | 0 | 1 | 1 | 0 | 0 | 0 | 0 | 0 | 0 | 0 | 0 | AD8 | AD7 | AD6 | AD5 | AD4 | AD3 | AD2 | AD1 | AE2 | AE1 | C4(1) | C3(0) | C2(1) | C1(0) |

REGISTER 11

| RESERVED | | | | | | | | | | | | | | | | | | | | | | | | | | | | CONTROL BITS | | | | |
|----------|------|------|------|------|------|------|------|------|------|------|------|------|------|------|------|------|------|------|------|------|------|-----|-----|-----|-----|-----|-----|--------------|-------|-------|-------|-------|
| DB31 | DB30 | DB29 | DB28 | DB27 | DB26 | DB25 | DB24 | DB23 | DB22 | DB21 | DB20 | DB19 | DB18 | DB17 | DB16 | DB15 | DB14 | DB13 | DB12 | DB11 | DB10 | DB9 | DB8 | DB7 | DB6 | DB5 | DB4 | DB3 | DB2 | DB1 | DB0 | |
| 0 | 0 | 0 | 0 | 0 | 0 | 0 | 0 | 0 | 1 | 1 | 0 | 0 | 0 | 0 | 1 | 0 | 0 | 1 | 1 | 0 | 0 | 0 | 0 | 0 | 0 | 0 | 0 | 0 | C4(1) | C3(0) | C2(1) | C1(1) |

REGISTER 12

| RESYNC CLOCK | | | | | | | | | | | | | | | | RESERVED | | | | | | | | | | | | | | | | CONTROL BITS | | | |
|--------------|------|------|------|------|------|------|------|------|------|------|------|------|------|------|------|----------|------|------|------|------|------|-----|-----|-----|-----|-----|-----|-------|-------|-------|-------|--------------|--|--|--|
| DB31 | DB30 | DB29 | DB28 | DB27 | DB26 | DB25 | DB24 | DB23 | DB22 | DB21 | DB20 | DB19 | DB18 | DB17 | DB16 | DB15 | DB14 | DB13 | DB12 | DB11 | DB10 | DB9 | DB8 | DB7 | DB6 | DB5 | DB4 | DB3 | DB2 | DB1 | DB0 | | | | |
| P16 | P15 | P14 | P13 | P12 | P11 | P10 | P9 | P8 | P7 | P6 | P5 | P4 | P3 | P2 | P1 | 0 | 0 | 0 | 0 | 0 | 1 | 0 | 0 | 0 | 0 | 0 | 1 | C4(1) | C3(1) | C2(0) | C1(0) | | | | |

Figure 40. Register Summary (Register 7 to Register 12)

12714-005

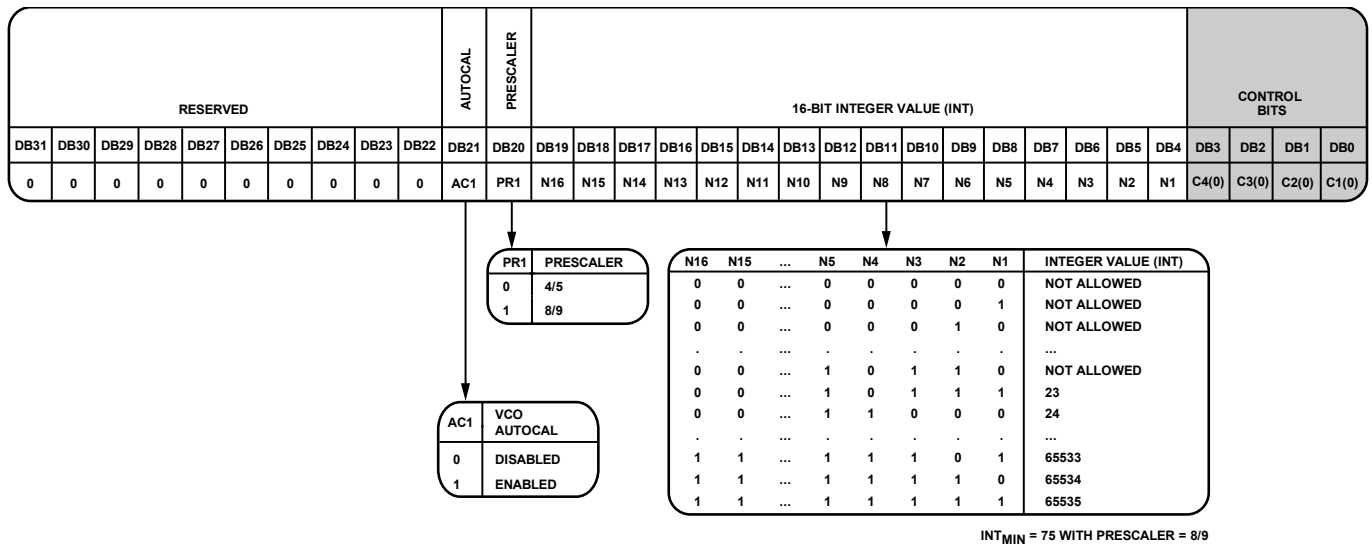

Figure 41. Register 0

REGISTER 0

Control Bits

With Bits[C4:C1] set to 0000, Register 0 is programmed. Figure 41 shows the input data format for programming this register.

Reserved

Bits[DB31:DB22] are reserved and must be set to 0.

Automatic Calibration (AUTOCAL)

Write to Register 0 to enact (by default) the VCO automatic calibration, and to choose the appropriate VCO and VCO subband. Write 1 to the AC1 bit (Bit DB21) to enable the automatic calibration, which is the recommended mode of operation.

Set the AC1 bit (Bit DB21) to 0 to disable the automatic calibration, which leaves the ADF5355 in the same band it was already in when Register 0 is updated.

Disable the automatic calibration only for fixed frequency applications, phase adjust applications, or very small (<10 kHz) frequency jumps.

Toggleing automatic calibration (AUTOCAL) is also required when changing frequency. See the Frequency Update Sequence section for more information.

Prescaler Value

The dual modulus prescaler (P/P + 1), along with the INT, FRACx, and MODx counters, determines the overall division ratio from the VCO output to the PFD input. The PR1 bit (Bit DB20) in Register 0 sets the prescaler value.

Operating at CML levels, the prescaler takes the clock from the VCO output and divides it down for the counters. It is based on a synchronous 4/5 core. When the prescaler is set to 4/5, the maximum RF frequency allowed is 7 GHz. The prescaler limits the INT value; therefore, if P is 4/5, N_{MIN} is 23, and if P is 8/9, N_{MIN} is 75.

16-Bit Integer Value

The 16 INT bits (Bits[DB19:DB4]) set the INT value, which determines the integer part of the feedback division factor. The INT value is used in Equation 3 (see the INT, FRAC, MOD, and R Counter Relationship section). All integer values from 23 to 32,767 are allowed for the 4/5 prescaler. For the 8/9 prescaler, the minimum integer value is 75, and the maximum value is 65,535.

| | | | | | | | | | | | | | | | | | | | | | | | | | | | | | | | |
|----------|------|------|------|--------------------------------------|------|------|------|------|------|------|------|------|------|------|------|------|------|------|------|------|------|-----|-----|-----|-----|-----|-----|--------------|-------|-------|-------|
| RESERVED | | | | 24-BIT MAIN FRACTIONAL VALUE (FRAC1) | | | | | | | | | | | | | | | | | | | | | | | | CONTROL BITS | | | |
| DB31 | DB30 | DB29 | DB28 | DB27 | DB26 | DB25 | DB24 | DB23 | DB22 | DB21 | DB20 | DB19 | DB18 | DB17 | DB16 | DB15 | DB14 | DB13 | DB12 | DB11 | DB10 | DB9 | DB8 | DB7 | DB6 | DB5 | DB4 | DB3 | DB2 | DB1 | DB0 |
| 0 | 0 | 0 | 0 | F24 | F23 | F22 | F21 | F20 | F19 | F18 | F17 | F16 | F15 | F14 | F13 | F12 | F11 | F10 | F9 | F8 | F7 | F6 | F5 | F4 | F3 | F2 | F1 | C4(0) | C3(0) | C2(0) | C1(1) |

| F24 | F23 | | F2 | F1 | MAIN FRACTIONAL VALUE (FRAC1) |
|-----|-----|-------|----|----|-------------------------------|
| 0 | 0 | | 0 | 0 | 0 |
| 0 | 0 | | 0 | 1 | 1 |
| 0 | 0 | | 1 | 0 | 2 |
| 0 | 0 | | 1 | 1 | 3 |
| . | . | | . | . | . |
| . | . | | . | . | . |
| . | . | | . | . | . |
| 1 | 1 | | 0 | 0 | 16777212 |
| 1 | 1 | | 0 | 1 | 16777213 |
| 1 | 1 | | 1 | 0 | 16777214 |
| 1 | 1 | | 1 | 1 | 16777215 |

¹DBR = DOUBLE BUFFERED REGISTER—BUFFERED BY THE WRITE TO REGISTER 0.

Figure 42. Register 1

REGISTER 1

Control Bits

With Bits[C4:C1] set to 0001, Register 1 is programmed. Figure 42 shows the input data format for programming this register.

Reserved

Bits[DB31:DB28] are reserved and must be set to 0.

24-Bit Main Fractional Value

The 24 FRAC1 bits (Bits[DB27:DB4]) set the numerator of the fraction that is input to the Σ - Δ modulator. This fraction, along with the INT value, specifies the new frequency channel that the synthesizer locks to, as shown in the RF Synthesizer—A Worked Example section. FRAC1 values from 0 to (MOD1 – 1) cover channels over a frequency range equal to the PFD reference frequency.

12714-037

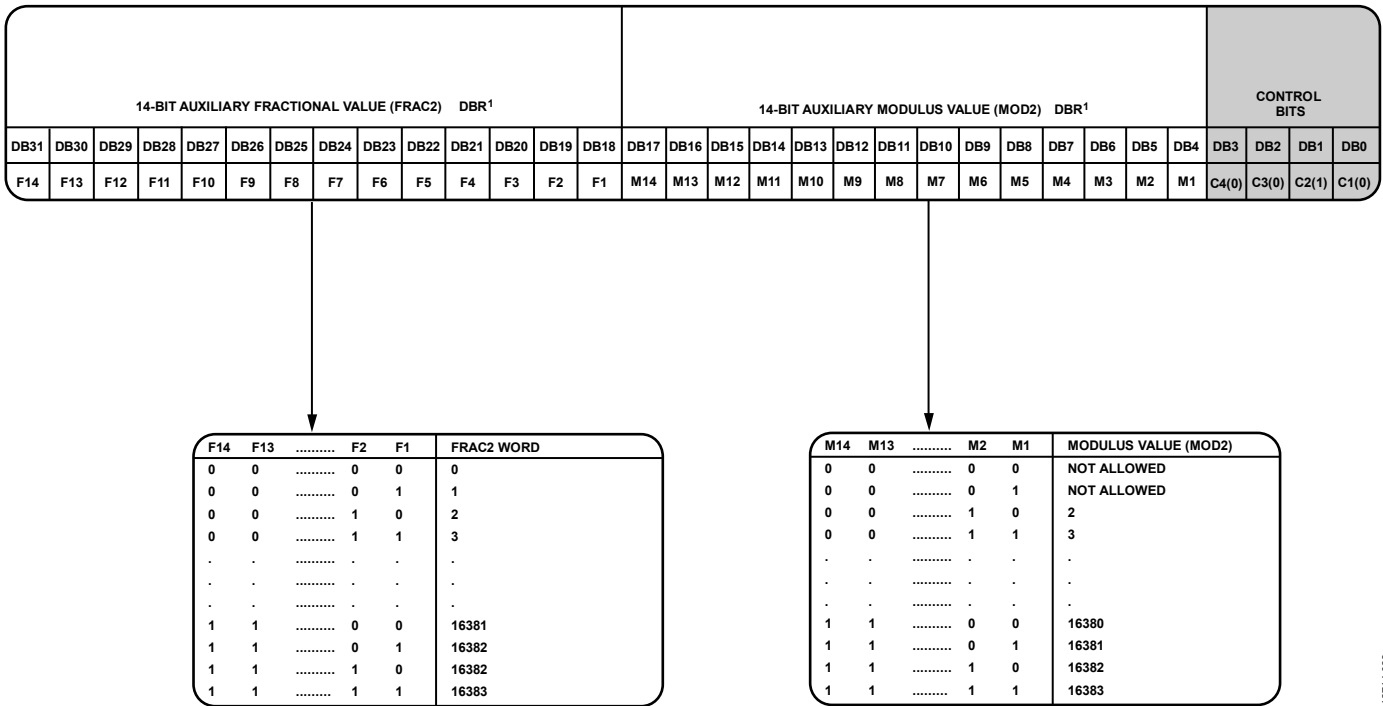

¹DBR = DOUBLE BUFFERED REGISTER—BUFFERED BY THE WRITE TO REGISTER 0.

Figure 43. Register 2

REGISTER 2

Control Bits

With Bits[C4:C1] set to 0010, Register 2 is programmed. Figure 43 shows the input data format for programming this register.

14-Bit Auxiliary Fractional Value (FRAC2)

The 14-bit auxiliary fractional value (Bits[DB31:DB18]) controls the auxiliary fractional word. FRAC2 must be less than the MOD2 value programmed in Register 2.

14-Bit Auxiliary Modulus Value (MOD2)

The 14-bit auxiliary modulus value (Bits[DB17:DB4]) sets the auxiliary fractional modulus. Use MOD2 to correct any residual error due to the main fractional modulus.

12714-038

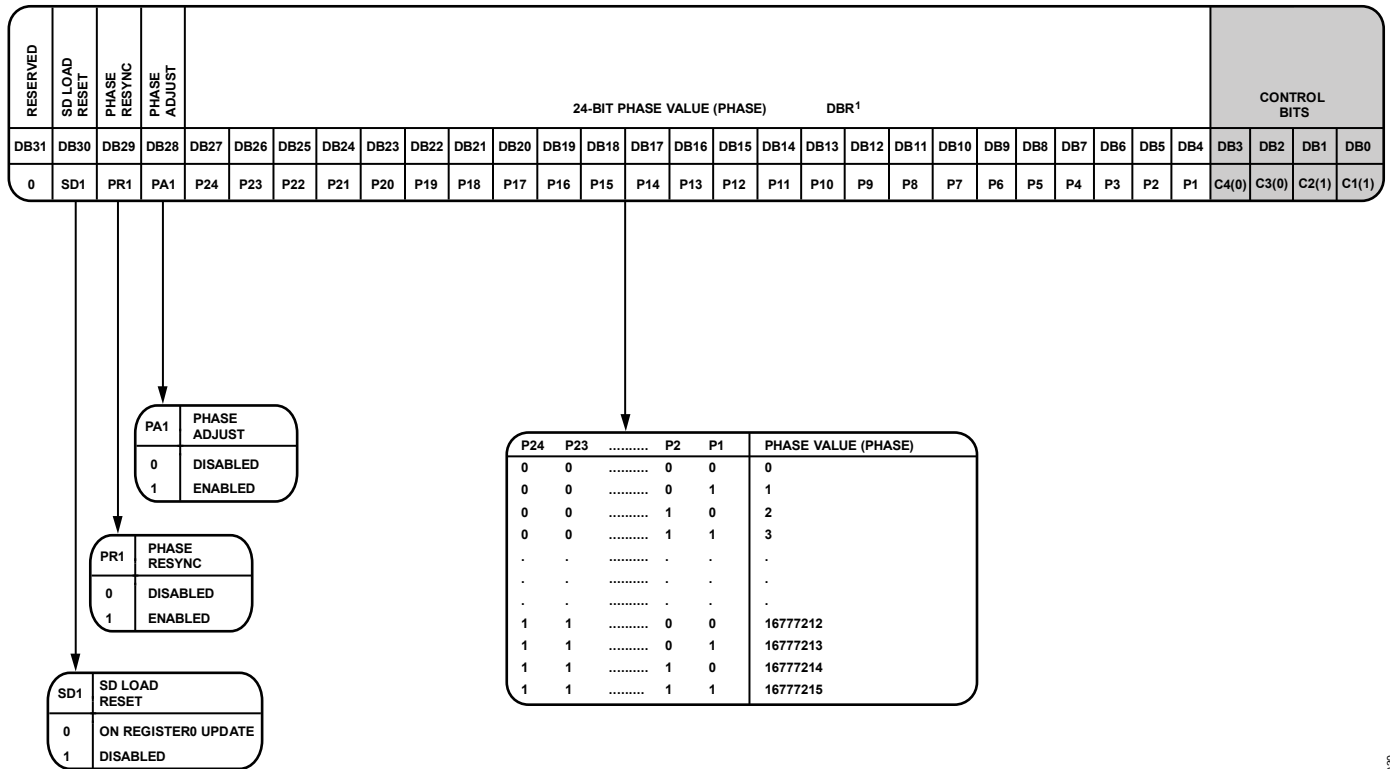

¹DBR = DOUBLE BUFFERED REGISTER—BUFFERED BY THE WRITE TO REGISTER 0.

Figure 44. Register 3

REGISTER 3

Control Bits

With Bits[C4:C1] set to 0011, Register 3 is programmed. Figure 44 shows the input data format for programming this register.

Reserved

Bit DB31 is reserved and must be set to 0.

SD Load Reset

When writing to Register 0, the Σ-Δ modulator resets. For applications in which the phase is continually adjusted, this may not be desirable; therefore, in these cases, the Σ-Δ reset can be disabled by writing a 1 to the SD1 bit (Bit DB30).

Phase Resync

To use the phase resynchronization feature, the PR1 bit (Bit DB29) must be set to 1. If unused, the bit can be programmed to 0. The phase resync timer must also be used in Register 12 to ensure that the resynchronization feature is applied after PLL has settled to the final frequency. If the PLL has not settled to the final frequency, phase resync may not function correctly. Resynchronization is useful in phased array and beam forming applications. It ensures repeatability of output phase when programming the same frequency. In phase critical applications that use frequencies requiring the output divider (<3400 MHz), it is necessary to feed the N divider with the divided VCO frequency as distinct from the fundamental VCO frequency. This is achieved by

programming the D13 bit (Bit DB24) in Register 6 to 0, which ensures divided feedback to the N divider.

Phase resynchronization operates only when FRAC2 = 0.

For resync applications, enable the SD load reset in Register 3 by setting DB30 to 0.

Phase Adjust

To adjust the relative output phase of the ADF5355 on each Register 0 update, set the PA1 bit (Bit DB28) to 1. This feature differs from the resynchronization feature in that it is useful when adjustments to phase are made continually in an application. For this function, disable the VCO automatic calibration by setting the AC1 bit (Bit DB21) in Register 0 to 0, and disable the SD load reset by setting the SD1 bit (Bit DB30) in Register 3 to 1. Note that phase resync and phase adjust cannot be used simultaneously.

24-Bit Phase Value

The phase of the RF output frequency can adjust in 24-bit steps, from 0° (0) to 360° (2²⁴ - 1). For phase adjust applications, the phase is set by

$$(Phase\ Value / 16,777,216) \times 360^\circ$$

When the phase value is programmed to Register 3, each subsequent adjustment of Register 0 increments the phase by the value in this equation.

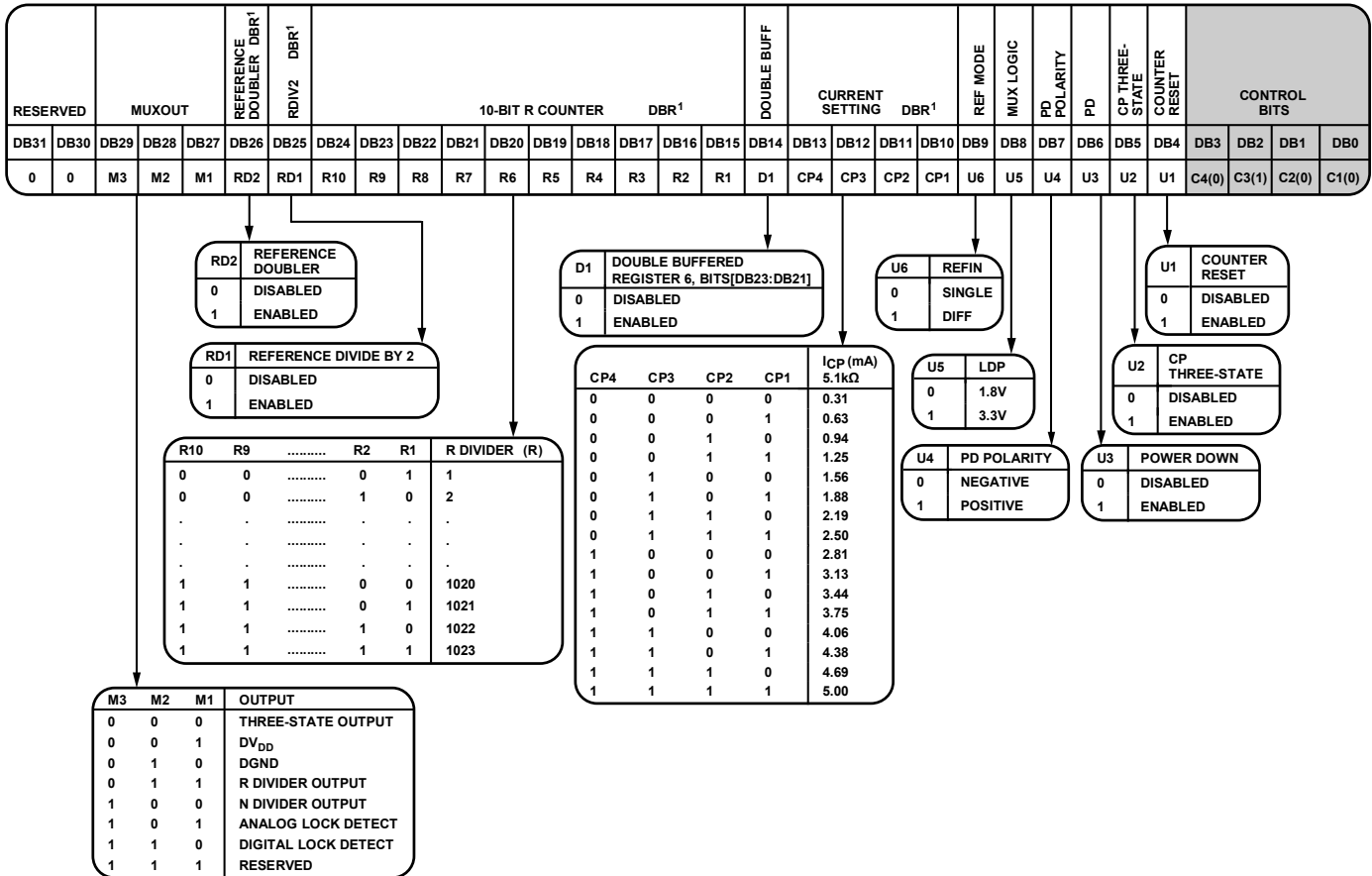

¹DBR = DOUBLE BUFFERED REGISTER—BUFFERED BY THE WRITE TO REGISTER 0.

Figure 45. Register 4

REGISTER 4

Control Bits

With Bits[C4:C1] set to 0100, Register 4 is programmed. Figure 45 shows the input data format for programming this register.

Reserved

Bits[DB31:DB30] are reserved and must be set to 0.

MUXOUT

The on-chip multiplexer (MUXOUT) is controlled by Bits[DB29:DB27]. For additional details, see Figure 45.

When changing frequency, that is, writing Register 0, MUXOUT must not be set to N divider output or R divider output. If needed, enable these functions after locking to the new frequency.

Reference Doubler

Setting the RD2 bit (Bit DB26) to 0 feeds the reference frequency signal directly to the 10-bit R counter, disabling the doubler. Setting this bit to 1 multiplies the reference frequency by a factor of 2 before feeding it into the 10-bit R counter. When the doubler is disabled, the REF_{IN} falling edge is the active edge at the PFD input to the fractional synthesizer. When the doubler is enabled, both the rising and falling edges of the reference frequency become active edges at the PFD input.

The maximum allowable reference frequency when the doubler is enabled is 100 MHz.

RDIV2

Setting the RDIV2 bit (Bit DB25) to 1 inserts a divide by 2, toggle flip-flop between the R counter and PFD, which extends the maximum reference frequency input rate. This function provides a 50% duty cycle signal at the PFD input.

10-Bit R Counter

The 10-bit R counter divides the input reference frequency (REF_{IN}) to produce the reference clock to the PFD. Division ratios range from 1 to 1023.

Double Buffer

The D1 bit (Bit DB14) enables or disables double buffering of the RF divider select bits (Bits[DB23:DB21]) in Register 6. The Program Modes section explains how double buffering works.

Charge Pump Current Setting

The CP4 to CP1 bits (Bits[DB13:DB10]) set the charge pump current. Set this value to the charge pump current that the loop filter is designed with (see Figure 45). For the lowest spurs, the 0.9 mA setting is recommended.

Reference Mode

The ADF5355 permits use of either differential or single-ended reference sources.

For optimum integer boundary spur performance, it is recommended to use the single-ended setting for all references up to 250 MHz (even if using a differential reference signal). Use the differential setting for reference frequencies above 250 MHz.

Level Select

To assist with logic compatibility, MUXOUT is programmable to two logic levels. Set the U5 bit (Bit DB8) to 0 to select 1.8 V logic, and set it to 1 to select 3.3 V logic.

Phase Detector Polarity

The U4 bit (Bit DB7) sets the phase detector polarity. When a passive loop filter or a noninverting active loop filter is used, set DB7 to 1 (positive). If an active filter with an inverting characteristic is used, set this bit to 0 (negative).

Power-Down

The U3 bit (Bit DB6) sets the programmable power-down mode. Setting DB6 to 1 performs a power-down. Setting DB6 to 0 returns the synthesizer to normal operation. In software or hardware power-down mode, the ADF5355 retains all information in its registers. The register contents are only lost if the supply voltages are removed.

When power-down activates, the following events occur:

- The synthesizer counters are forced to their load state conditions.
- The VCO powers down.
- The charge pump is forced into three-state mode.
- The digital lock detect circuitry resets.
- The RF_{OUTA+}/RF_{OUTA-} and RF_{OUTB} output stages are disabled.
- The input registers remain active and capable of loading and latching data.

Charge Pump Three-State

Setting the U2 bit (Bit DB5) to 1 puts the charge pump into three-state mode. Set DB5 to 0 for normal operation.

Counter Reset

The U1 bit (Bit DB4) resets the R counter, N counter, and VCO band select of the ADF5355. When DB4 is set to 1, the RF synthesizer N counter, R counter, and VCO band select are reset. For normal operation, set DB4 to 0.

Toggling counter reset is also required when changing frequency. See the Frequency Update Sequence section for more information.

REGISTER 5

The bits in Register 5 are reserved and must be programmed as described in Figure 46, using a hexadecimal word of 0x00800025.

| | | | | | | | | | | | | | | | | | | | | | | | | | | | | | | | | |
|----------|------|------|------|------|------|------|------|------|------|------|------|------|------|------|------|------|------|------|------|------|------|-----|-----|-----|-----|-----|-----|--------------|-------|-------|-------|-------|
| RESERVED | | | | | | | | | | | | | | | | | | | | | | | | | | | | CONTROL BITS | | | | |
| DB31 | DB30 | DB29 | DB28 | DB27 | DB26 | DB25 | DB24 | DB23 | DB22 | DB21 | DB20 | DB19 | DB18 | DB17 | DB16 | DB15 | DB14 | DB13 | DB12 | DB11 | DB10 | DB9 | DB8 | DB7 | DB6 | DB5 | DB4 | DB3 | DB2 | DB1 | DB0 | |
| 0 | 0 | 0 | 0 | 0 | 0 | 0 | 0 | 0 | 1 | 0 | 0 | 0 | 0 | 0 | 0 | 0 | 0 | 0 | 0 | 0 | 0 | 0 | 0 | 0 | 0 | 0 | 1 | 0 | C4(0) | C3(1) | C2(0) | C1(1) |

Figure 46. Register 5 (0x00800025)

12714-041

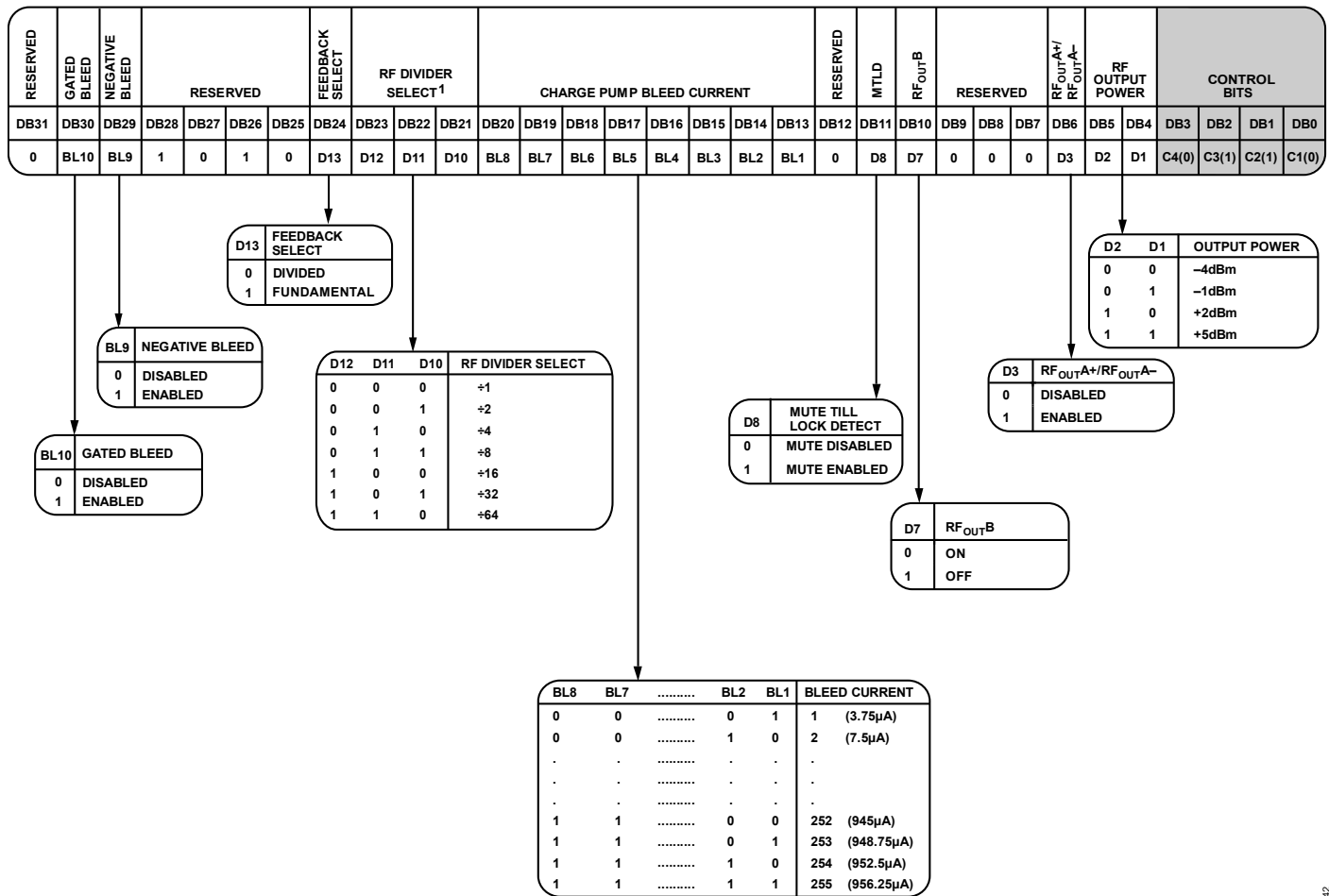

¹BITS[DB23:DB21] ARE BUFFERED BY A WRITE TO REGISTER 0 WHEN THE DOUBLE BUFFER BIT, BIT DB14 OF REGISTER 4, IS ENABLED.

Figure 47. Register 6

12714-042

REGISTER 6

Control Bits

With Bits[C4:C1] set to 0110, Register 6 is programmed. Figure 47 shows the input data format for programming this register.

Reserved

Bit DB31 is reserved and must be set to 0.

Gated Bleed

Bleed currents can be used for improving phase noise and spurs; however, due to a potential impact on lock time, the gated bleed bit, BL10 (Bit DB30), if set to 1, ensures bleed currents are not switched on until the digital lock detect asserts logic high. Note that this function requires digital lock detect to be enabled.

Negative Bleed

Use of constant negative bleed is recommended for most fractional-N applications because it improves the linearity of the charge pump, leading to lower noise and spurious signals than leaving it off. To enable negative bleed, write 1 to BL9 (Bit DB29), and to disable negative bleed, write 0 to BL9 (Bit DB29).

Do not use negative bleed when operating in integer-N mode, that is, when FRAC1 = FRAC2 = 0, or when f_{FPD} is greater than 100 MHz.

Reserved

Bit DB28 is reserved and must be set to 1. Bits[DB27:DB25] are reserved and must be set to 010.

Feedback Select

D13 (Bit DB24) selects the feedback from the output of the VCO to the N counter. When D13 is set to 1, the signal is taken directly from the VCO. When this bit is set to 0, the signal is taken from the output of the output dividers. The dividers enable coverage of the wide frequency band (3.4 GHz to 6.8 GHz). When the divider is enabled and the feedback signal is taken from the output, the RF output signals of two separately configured PLLs are in phase. Divided feedback is useful in some applications where the positive interference of signals is required to increase the power.

Divider Select

D12 to D10 (Bits[DB23:DB21]) select the value of the RF output divider (see Figure 47).

Charge Pump Bleed Current

BL8 to BL1 (Bits[DB20:DB13]) control the level of the bleed current added to the charge pump output. This current optimizes the phase noise and spurious levels from the device.

Tests have shown that the optimal bleed set is the following:

$$4/N < I_{BLEED}/I_{CP} < 10/N$$

where:

N is the value of the feedback counter from the VCO to the PFD.

I_{BLEED} is the value of constant negative bleed applied to the charge pump, which is set by the contents of Bits[DB20:DB13].

I_{CP} is the value of charge pump current setting, Bits[DB13:DB10] of Register 4.

Reserved

Bit DB12 is reserved and must be set to 0.

Mute Till Lock Detect

When D8 (Bit DB11) is set to 1, the supply current to the RF output stage is shut down until the device achieves lock, as determined by the digital lock detect circuitry.

RF Output B Enable

D7 (Bit DB10) enables or disables the high frequency RF output (RF_{OUTB}). If DB10 is set to 0, the auxiliary high frequency RF output is enabled. If DB10 is set to 1, the auxiliary RF output is disabled.

Reserved

Bits[DB9:DB7] are reserved and must be set to 000.

RF Output A Enable

D3 (Bit DB6) enables or disables the primary RF output (RF_{OUTA+}/RF_{OUTA-}). If DB6 is set to 0, the primary RF output is disabled. If DB6 is set to 1, the primary RF output is enabled.

Output Power

D2 and D1 (Bits[DB5:DB4]) set the value of the primary RF output power level (see Figure 47).

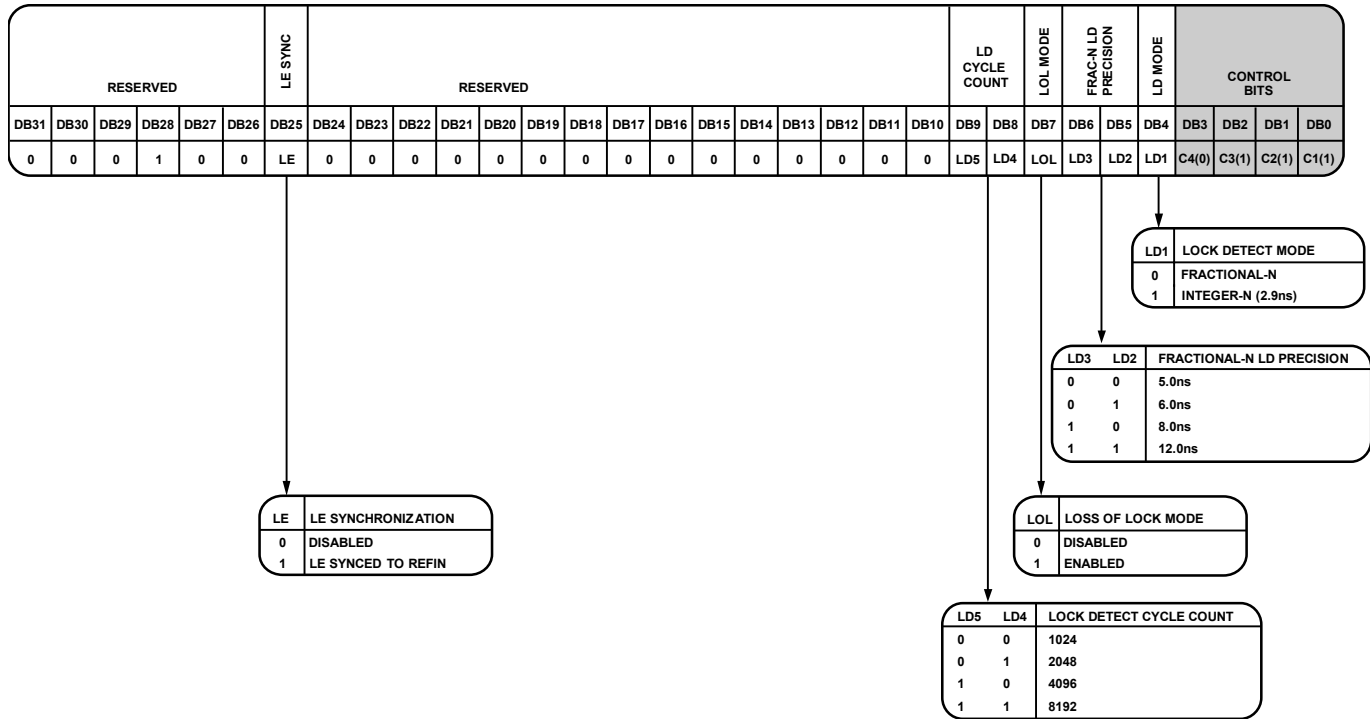

Figure 48. Register 7

12714-043

REGISTER 7

Control Bits

With Bits[C4:C1] set to 0111, Register 7 is programmed. Figure 48 shows the input data format for programming this register.

Reserved

Bits[DB31:DB29] are reserved and must be set to 0. Bit DB28 is reserved and must be set to 1. Bits[DB27:DB26] are reserved and must be set to 0.

LE Sync

When set to 1, Bit DB25 ensures that the load enable (LE) edge is synchronized internally with the rising edge of reference input frequency. This synchronization prevents the rare event of reference and RF dividers loading at the same time as a falling edge of the reference frequency, which can lead to longer lock times.

Reserved

Bits[DB24:DB10] are reserved and must be set to 0.

Fractional-N Lock Detect Count (LDC)

LD5 and LD4 (Bits[DB9:DB8]) set the number of consecutive cycles counted by the lock detect circuitry before asserting lock detect high. See Figure 48 for details.

Loss of Lock (LOL) Mode

Set the LOL mode bit (Bit DB7) to 1 when the application is a fixed frequency application in which the reference (REF_{IN}) is likely to be removed, such as a clocking application. The standard lock detect circuit assumes that REF_{IN} is always present; however, this may not be the case with clocking applications. To enable this functionality, set DB7 to 1. LOL mode does not function reliably when using differential REF_{IN} mode.

Fractional-N Lock Detect Precision (LDP)

LD3 and LD2 (Bits[DB6:DB5]) set the precision of the lock detect circuitry in fractional-N mode. LDP is available at 5 ns, 6 ns, 8 ns, or 12 ns. If bleed currents are used, use 12 ns.

Lock Detect Mode (LDM)

If LD1 (Bit DB4) is set to 0, each reference cycle is set by fractional-N lock detect precision as described in the Fractional-N Lock Detect Count (LDC) section. If DB4 is set to 1, each reference cycle is 2.9 ns long, which is more appropriate for integer-N applications.

| | | | | | | | | | | | | | | | | | | | | | | | | | | | | | | | |
|----------|------|------|------|------|------|------|------|------|------|------|------|------|------|------|------|------|------|------|------|------|------|-----|-----|-----|-----|-----|-----|--------------|-------|-------|-------|
| RESERVED | | | | | | | | | | | | | | | | | | | | | | | | | | | | CONTROL BITS | | | |
| DB31 | DB30 | DB29 | DB28 | DB27 | DB26 | DB25 | DB24 | DB23 | DB22 | DB21 | DB20 | DB19 | DB18 | DB17 | DB16 | DB15 | DB14 | DB13 | DB12 | DB11 | DB10 | DB9 | DB8 | DB7 | DB6 | DB5 | DB4 | DB3 | DB2 | DB1 | DB0 |
| 0 | 0 | 0 | 1 | 0 | 0 | 0 | 0 | 0 | 0 | 1 | 0 | 1 | 1 | 0 | 1 | 0 | 0 | 0 | 0 | 0 | 1 | 0 | 0 | 0 | 0 | 1 | 0 | C4(1) | C3(0) | C2(0) | C1(0) |

Figure 49. Register 8 (0x102D0428)

| | | | | | | | | | | | | | | | | | | | | | | | | | | | | | | | |
|-------------------|------|------|------|------|------|------|------|---------|------|------|------|------|------|------|------|-------------------------|------|------|------|------|--------------------------|-----|-----|-----|-----|--------------|-----|-------|-------|-------|-------|
| VCO BAND DIVISION | | | | | | | | TIMEOUT | | | | | | | | AUTOMATIC LEVEL TIMEOUT | | | | | SYNTHESIZER LOCK TIMEOUT | | | | | CONTROL BITS | | | | | |
| DB31 | DB30 | DB29 | DB28 | DB27 | DB26 | DB25 | DB24 | DB23 | DB22 | DB21 | DB20 | DB19 | DB18 | DB17 | DB16 | DB15 | DB14 | DB13 | DB12 | DB11 | DB10 | DB9 | DB8 | DB7 | DB6 | DB5 | DB4 | DB3 | DB2 | DB1 | DB0 |
| VC8 | VC7 | VC6 | VC5 | VC4 | VC3 | VC2 | VC1 | TL10 | TL9 | TL8 | TL7 | TL6 | TL5 | TL4 | TL3 | TL2 | TL1 | AL5 | AL4 | AL3 | AL2 | AL1 | SL5 | SL4 | SL3 | SL2 | SL1 | C4(1) | C3(0) | C2(0) | C1(1) |

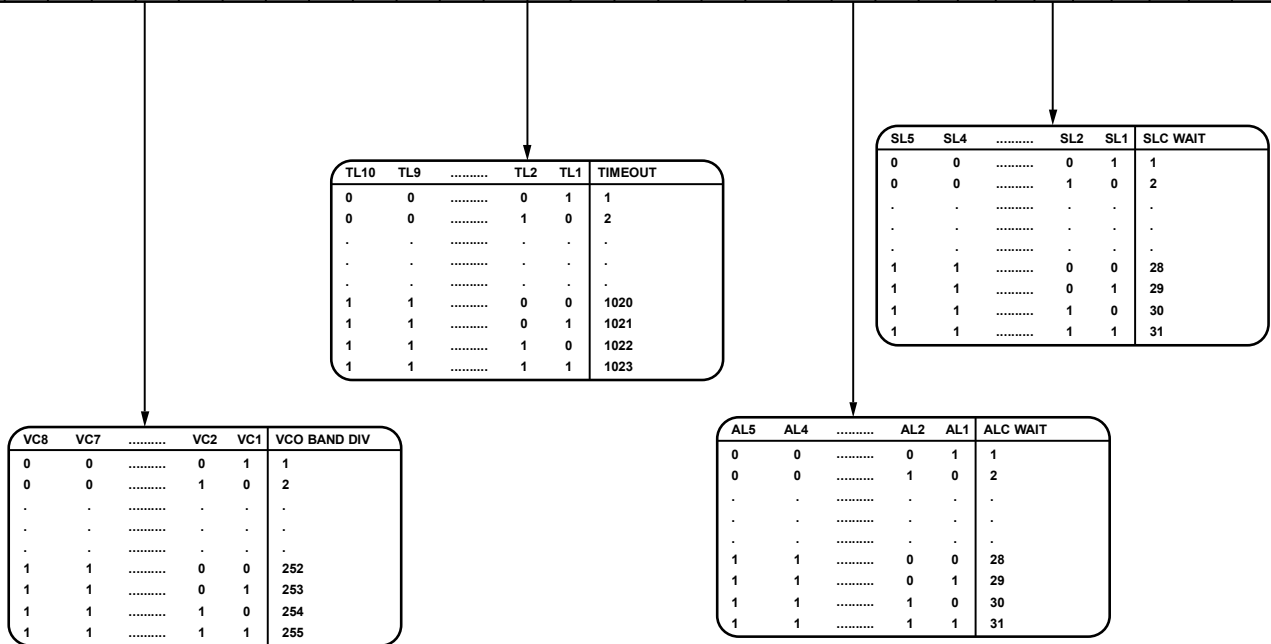

Figure 50. Register 9

REGISTER 8

The bits in this register are reserved and must be programmed as shown in Figure 49, using a hexadecimal word of 0x102D0428.

REGISTER 9

For a worked example and more information, see the Lock Time section.

Control Bits

With Bits[C4:C1] set to 1001, Register 9 is programmed. Figure 50 shows the input data format for programming this register.

VCO Band Division

VC8 to VC1 (Bits[DB31:DB24]) set the value of the VCO band division clock. Determine the value of this clock by

$$VCO\ Band\ Div = \text{Ceiling}(f_{PFD}/2,400,000)$$

Timeout

TL10 to TL1 (Bits[DB23:DB14]) set the timeout value for the VCO band select.

Automatic Level Calibration (ALC) Timeout

AL5 to AL1 (Bits[DB13:DB9]) set the timer value used for the automatic level calibration of the VCO. This function combines the PFD frequency, the timeout variable, and ALC wait variable. Choose the ALC such that the following equation is always greater than 50 μs.

$$ALC\ Wait > (50\ \mu s \times f_{PFD})/Timeout$$

Synthesizer Lock Timeout

SL5 to SL1 (Bits[DB8:DB4]) set the synthesizer lock timeout value. This value allows the V_{TUNE} force to settle on the V_{TUNE} pin. The value must be 20 μs. Calculate the value using the following equation:

$$Synthesizer\ Lock\ Timeout > (20\ \mu s \times f_{PFD})/Timeout$$

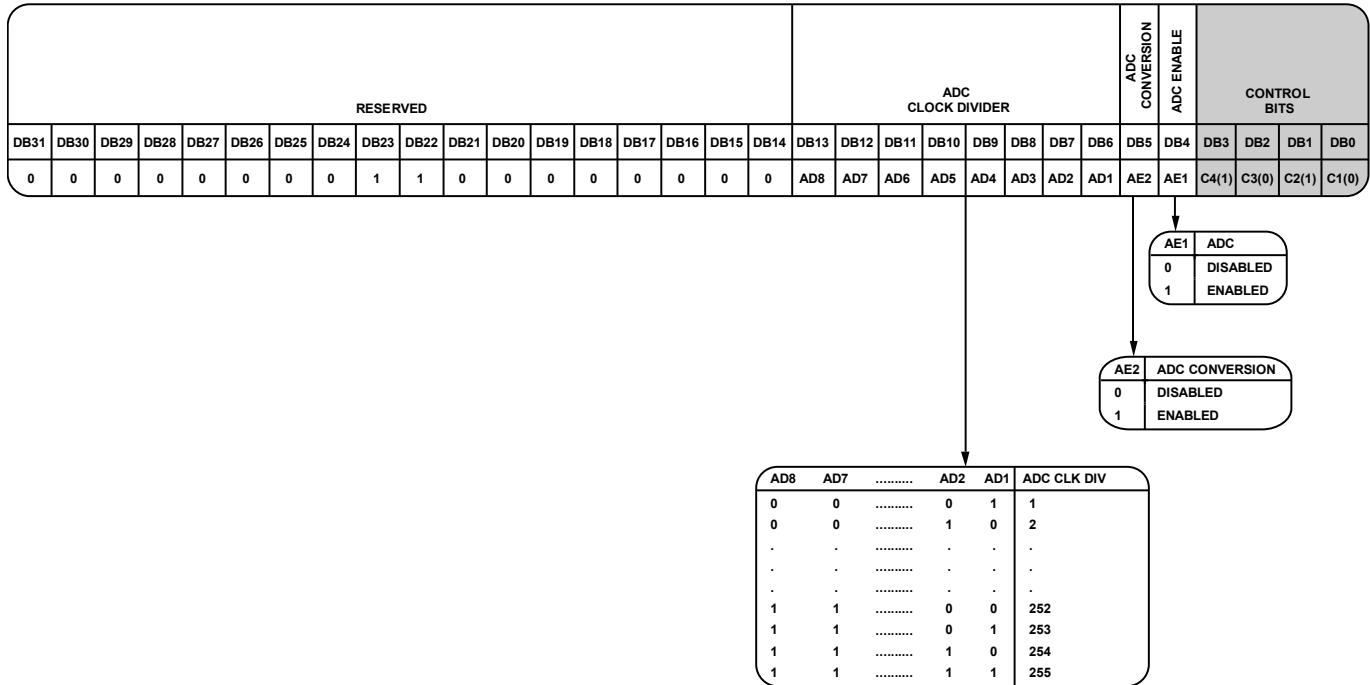

Figure 51. Register 10

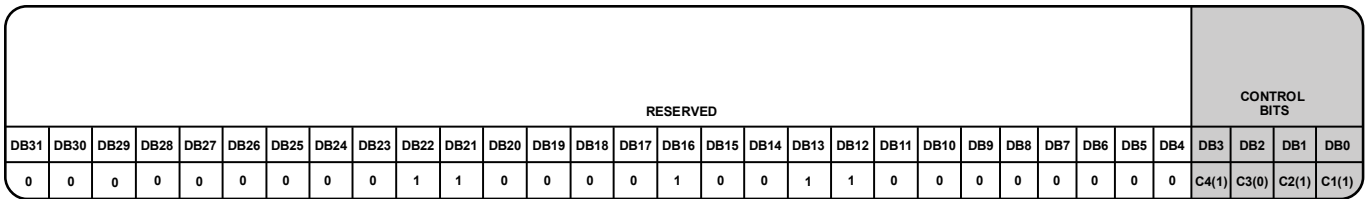

Figure 52. Register 11

REGISTER 10

Control Bits

With Bits[C4:C1] set to 1010, Register 10 is programmed. Figure 51 shows the input data format for programming this register.

Reserved

Bits[DB31:DB14] are reserved. Bits[DB23:DB22] must be set to 11, and all other bits in this range must be set to 0.

ADC Conversion Clock (ADC_CLK_DIV)

An on-board analog-to-digital converter (ADC) determines the V_{TUNE} setpoint relative to the ambient temperature of the ADF5355 environment. The ADC ensures that the initial tuning voltage in any application is chosen correctly to avoid any temperature drift issues.

The ADC uses a clock that is equal to the output of the R counter (or the PFD frequency) divided by ADC_CLK_DIV.

AD8 to AD1 (Bits[DB13:DB6]) set the value of this divider. On power-up, the R counter is not programmed; however, in these power-up cases, it defaults to R = 1.

Choose the value such that

$$ADC_CLK_DIV = \text{Ceiling}(((f_{PFD}/100,000) - 2)/4)$$

where Ceiling() rounds up to the nearest integer.

For example, for f_{PFD} = 61.44 MHz, set ALC_CLK_DIV = 154 so that the ADC clock frequency is 99.417 kHz.

If ADC_CLK_DIV is greater than 255, set it to 255.

ADC Conversion Enable

AE2 (Bit DB5) ensures that the ADC performs a conversion when a write to Register 10 is performed. It is recommended to enable this mode.

ADC Enable

AE1 (Bit DB4), when set to 1, powers up the ADC for the temperature dependent V_{TUNE} calibration. It is recommended to always use this function.

REGISTER 11

The bits in this register are reserved and must be programmed as described in Figure 52, using a hexadecimal word of 0x0061300B.

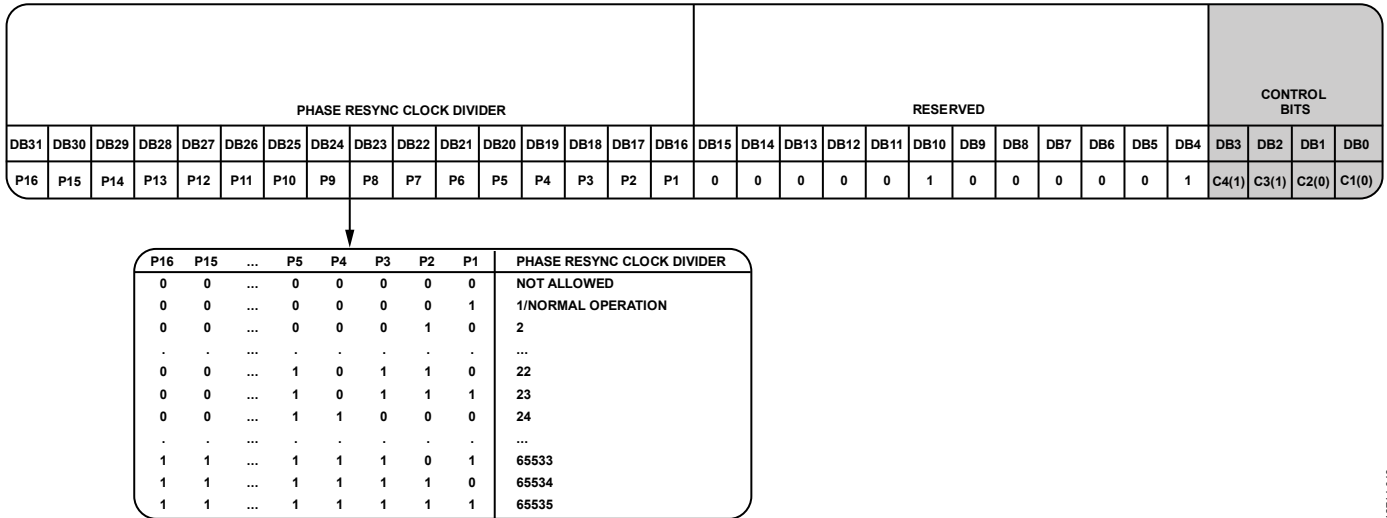

Figure 53. Register 12

REGISTER 12

Control Bits

With Bits[C4:C1] set to 1100, Register 12 is programmed. Figure 53 shows the input data format for programming this register.

Phase Resync Clock Divider Value

P16 to P1 (Bits[DB31:DB16]) set the timeout counter for activation of phase resync. This value must be set such that a resync happens immediately after (and not before) the PLL has achieved lock after reprogramming.

Calculate the timeout value using the following equation:

$$Time\ Out\ Value = Phase\ Resync\ Clock\ Divider / f_{PPFD}$$

When not using phase resync, set these bits to 1 for normal operation.

Reserved

Bits[DB15:DB4] are reserved. Bit DB10 and Bit DB4 must be set to 1, and all other bits in this range must be set to 0.

REGISTER INITIALIZATION SEQUENCE

At initial power-up, after the correct application of voltages to the supply pins, the registers must be programmed in sequence. For $f_{PPFD} \leq 75$ MHz, use the following sequence:

1. Register 12.
2. Register 11.
3. Register 10.
4. Register 9.
5. Register 8.
6. Register 7.
7. Register 6.
8. Register 5.
9. Register 4.
10. Register 3.
11. Register 2.

12. Register 1.
13. Wait >16 ADC clock cycles. For example, if the ADC clock = 99.417 kHz, wait 16/99,417 sec = 161 μ s. See the Register 10 section for more information.
14. Register 0.

For $f_{PPFD} > 75$ MHz (initially locked with half f_{PPFD}), use the following sequence:

1. Register 12.
2. Register 11.
3. Register 10.
4. Register 9.
5. Register 8.
6. Register 7.
7. Register 6.
8. Register 5.
9. Register 4 (with the R divider doubled to output half f_{PPFD}).
10. Register 3.
11. Register 2 (for halved f_{PPFD}).
12. Register 1 (for halved f_{PPFD}).
13. Wait >16 ADC clock cycles. For example, if the ADC clock = 99.417 kHz, wait 16/99417 sec = 161 μ s. See the Register 10 section for more information.
14. Register 0 (for halved f_{PPFD} ; autocalibration enabled).
15. Register 4 (with the R divider set for desired f_{PPFD}).
16. Register 2 (for desired f_{PPFD}).
17. Register 1 (for desired f_{PPFD}).
18. Register 0 (for desired f_{PPFD} ; autocalibration disabled).

FREQUENCY UPDATE SEQUENCE

Frequency updates require updating the auxiliary modulator (MOD2) in Register 2, the fractional value (FRAC1) in Register 1, and the integer value (INT) in Register 0. It is recommended to perform a temperature dependent V_{TUNE} calibration by updating Register 10 first. Toggling the counter reset bit (Register 4) is also required. Therefore, for $f_{PPFD} \leq 75$ MHz, use the following sequence:

1. Register 10.
2. Register 4 (counter reset enabled, DB4 = 1).
3. Register 2 (new FRAC2 and MOD2).
4. Register 1 (new FRAC1).
5. Register 0 (new INT and AUTOCAL disabled, DB21 = 0).
6. Register 4 (counter reset disabled, DB4 = 0).
7. Wait >16 ADC clock cycles. For example, if the ADC clock = 99.417 kHz, wait 16/99417 sec = 161 μs. See the Register 10 section for more information.
8. Register 0 (new INT and AUTOCAL enabled, DB21 = 1).

The frequency change occurs on the second write to Register 0.

For $f_{\text{PFD}} > 75$ MHz (initially locked with half f_{PFD}), use the following sequence:

1. Register 10.
2. Register 4 (counter reset enabled, DB4 = 1).
3. Register 2 (for halved f_{PFD}).
4. Register 1 (for halved f_{PFD}).
5. Register 0 (for halved f_{PFD} ; autocalibration disabled)
6. Register 4 (counter reset disabled, DB4 = 0).
7. Wait >16 ADC clock cycles. For example, if the ADC clock = 99.417 kHz, wait 16/99417 sec = 161 μs. See the Register 10 section for more information.
8. Register 0 (for halved f_{PFD} ; autocalibration enabled).
9. Register 2 (for desired f_{PFD}).
10. Register 1 (for desired f_{PFD}).
11. Register 0 (for desired f_{PFD} ; autocalibration disabled).

The frequency change only occurs when writing to Register 0.

RF SYNTHESIZER—A WORKED EXAMPLE

Use the following equations to program the ADF5355 synthesizer:

$$RF_{\text{OUT}} = INT + \frac{FRAC1 + \frac{FRAC2}{MOD2}}{MOD1} \times (f_{\text{PFD}}) / RF \text{ Divider} \quad (7)$$

where:

RF_{OUT} is the RF output frequency.

INT is the integer division factor.

$FRAC1$ is the fractionality.

$FRAC2$ is the auxiliary fractionality.

$MOD1$ is the fixed 24-bit modulus.

$MOD2$ is the auxiliary modulus.

$RF \text{ Divider}$ is the output divider that divides down the VCO frequency.

$$f_{\text{PFD}} = REF_{\text{IN}} \times ((1 + D)/(R \times (1 + T))) \quad (8)$$

where:

REF_{IN} is the reference frequency input.

D is the REF_{IN} doubler bit.

R is the REF reference division factor.

T is the reference divide by 2 bit (0 or 1).

For example, in a universal mobile telecommunication system (UMTS) where a 2112.8 MHz RF frequency output (RF_{OUT}) is required, a 122.88 MHz reference frequency input (REF_{IN}) is available. Note that the ADF5355 VCO operates in the

frequency range of 3.4 GHz to 6.8 GHz. Therefore, the RF divider of 2 must be used ($VCO \text{ frequency} = 4225.6 \text{ MHz}$, $RF_{\text{OUT}} = VCO \text{ frequency}/RF \text{ divider} = 4225.6 \text{ MHz}/2 = 2112.8 \text{ MHz}$).

The feedback path is also important. In this example, the VCO output is fed back before the output divider (see Figure 54).

In this example, the 122.88 MHz reference signal is divided by 2 to generate f_{PFD} of 61.44 MHz. The desired channel spacing is 200 kHz.

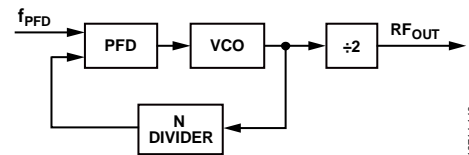

Figure 54. Loop Closed Before Output Divider

The worked example follows:

- $N = VCO_{\text{OUT}}/f_{\text{PFD}} = 4225.6 \text{ MHz}/61.44 \text{ MHz} = 68.7760416666666667$
- $INT = \text{int}(VCO \text{ frequency}/f_{\text{PFD}}) = 68$
- $FRAC = 0.7760416666666667$
- $MOD1 = 16,777,216$
- $FRAC1 = \text{int}(MOD1 \times FRAC) = 13019818$
- $\text{Remainder} = 0.6666666667 \text{ or } 2/3$
- $MOD2 = f_{\text{PFD}}/\text{GCD}(f_{\text{PFD}}, f_{\text{CHSP}}) = 61.44 \text{ MHz}/\text{GCD}(61.44 \text{ MHz}, 200 \text{ kHz}) = 1536$
- $FRAC2 = \text{Remainder} \times 1536 = 1024$

From Equation 8,

$$f_{\text{PFD}} = (122.88 \text{ MHz} \times (1 + 0)/2) = 61.44 \text{ MHz} \quad (x)$$

$$2112.8 \text{ MHz} = 61.44 \text{ MHz} \times ((INT + (FRAC1 + FRAC2/MOD2)/2^{24}))/2 \quad (9)$$

where:

$INT = 68$

$FRAC1 = 13,019,817$

$MOD2 = 1536$

$FRAC2 = 1024$

$RF \text{ Divider} = 2$

REFERENCE DOUBLER AND REFERENCE DIVIDER

The on-chip reference doubler allows the input reference signal to be doubled. The doubler is useful for increasing the PFD comparison frequency. To improve the noise performance of the system, increase the PFD frequency. Doubling the PFD frequency typically improves noise performance by 3 dB.

The reference divide by 2 divides the reference signal by 2, resulting in a 50% duty cycle PFD frequency.

SPURIOUS OPTIMIZATION AND FAST LOCK

Narrow loop bandwidths can filter unwanted spurious signals; however, these bandwidths typically have a long lock time. A wider loop bandwidth achieves faster lock times but may lead to increased spurious signals inside the loop bandwidth.

OPTIMIZING JITTER

For lowest jitter applications, use the highest possible PFD frequency to minimize the contribution of in-band noise from the PLL. Set the PLL filter bandwidth such that the in-band noise of the PLL intersects with the open-loop noise of the VCO, minimizing the contribution of both to the overall noise.

Use the [ADIsimPLL](#) design tool for this task.

SPUR MECHANISMS

This section describes the two different spur mechanisms that arise with a fractional-N synthesizer and how to minimize them in the [ADF5355](#).

Integer Boundary Spurs

One mechanism for fractional spur creation is the interactions between the RF VCO frequency and the reference frequency. When these frequencies are not integer related (the purpose of a fractional-N synthesizer), spur sidebands appear on the VCO output spectrum at an offset frequency that corresponds to the beat note or the difference in frequency between an integer multiple of the reference and the VCO frequency. These spurs are attenuated by the loop filter and are more noticeable on channels close to integer multiples of the reference where the difference frequency can be inside the loop bandwidth (thus the name, integer boundary spurs).

Reference Spurs

Reference spurs are generally not a problem in fractional-N synthesizers because the reference offset is far outside the loop bandwidth. However, any reference feedthrough mechanism that bypasses the loop can cause a problem. Feedthrough of low levels of on-chip reference switching noise, through the prescaler back to the VCO, can result in reference spur levels as high as -80 dBc.

LOCK TIME

The PLL lock time divides into a number of settings. All of these settings are modeled in the [ADIsimPLL](#) design tool.

Much faster lock times than those detailed in this data sheet are possible; contact Analog Devices for more information.

Lock Time—A Worked Example

Assume that $f_{\text{PFD}} = 61.44 \text{ MHz}$,

$$\text{VCO Band Div} = \text{Ceiling}(f_{\text{PFD}}/2,400,000) = 26$$

where Ceiling() rounds up to the nearest integer.

By combining

$$\text{ALC Wait} > (50 \mu\text{s} \times f_{\text{PFD}})/\text{Timeout}$$

$$\text{Synthesizer Lock Timeout} > (20 \mu\text{s} \times f_{\text{PFD}})/\text{Timeout}$$

It is found that

$$\text{ALC Wait} = 2.5 \times \text{Synthesizer Lock Timeout}$$

The ALC wait and synthesizer lock timeout values must be set to fulfill this equation. Both values are 5 bits wide; therefore, the maximum value for either is 31. There are several suitable values.

The following values meet the criteria:

$$\text{ALC Wait} = 30$$

$$\text{Synthesizer Lock Timeout} = 12$$

Finally, $\text{ALC Wait} > (50 \mu\text{s} \times f_{\text{PFD}})/\text{Timeout}$, is rearranged for

$$\text{Timeout} = \text{Ceiling}((f_{\text{PFD}} \times 50 \mu\text{s})/\text{ALC Wait})$$

$$\text{Timeout} = \text{Ceiling}((61.44 \text{ MHz} \times 50 \mu\text{s})/30) = 103$$

Synthesizer Lock Timeout

The synthesizer lock timeout ensures that the VCO calibration DAC, which forces V_{TUNE} , has settled to a steady value for the band select circuitry.

The timeout and synthesizer lock timeout variables programmed in Register 9 select the length of time the DAC is allowed to settle to the final voltage, before the VCO calibration process continues to the next phase, which is VCO band selection. The PFD frequency is the clock for this logic, and the duration is set by

$$\frac{\text{Timeout} \times \text{Synthesizer Lock Timeout}}{f_{\text{PFD}}}$$

The calculated time must be equal to or greater than 20 μs .

VCO Band Selection

Use the PFD frequency again as the clock for the band selection process. Calculate this value by

$$f_{\text{PFD}}/(\text{VCO Band Selection} \times 16) < 150 \text{ kHz}$$

The band selection takes 11 cycles of the previously calculated value. Calculate the duration by

$$11 \times (\text{VCO Band Selection} \times 16)/f_{\text{PFD}}$$

Automatic Level Calibration Timeout

Use the automatic level calibration (ALC) function to choose the correct bias current in the [ADF5355](#) VCO core. Calculate the time taken by

$$55 \times \text{ALC Wait} \times \text{Timeout}/f_{\text{PFD}}$$

PLL Low-Pass Filter Settling Time

The time taken for the loop to settle is inversely proportional to the low-pass filter bandwidth. The settling time is also modeled in the [ADIsimPLL](#) design tool.

The total lock time for changing frequencies is the sum of the four separate times (synthesizer lock, VCO band selection, ALC timeout, and PLL settling time) and is all modeled in the [ADIsimPLL](#) design tool.

APPLICATIONS INFORMATION

POWER SUPPLIES

The ADF5355 contains four multiband VCOs that together cover an octave range of frequencies. To ensure best performance, it is vital to connect a low noise regulator, such as the ADM7150, to the V_{VCO} pin. Connect the same regulator to V_{VCO}, V_{REGVCO}, and V_P.

For the 3.3 V supply pins, use an ADM7150 regulator. Figure 55 shows the recommended connections.

PRINTED CIRCUIT BOARD (PCB) DESIGN GUIDELINES FOR A CHIP-SCALE PACKAGE

The lands on the 32-lead lead frame chip-scale package are rectangular. The PCB pad for these lands must be 0.1 mm longer than the package land length and 0.05 mm wider than the package land width. Center each land on the pad to maximize the solder joint size.

The bottom of the chip-scale package has a central exposed thermal pad. The thermal pad on the PCB must be at least as

large as the exposed pad. On the PCB, there must be a minimum clearance of 0.25 mm between the thermal pad and the inner edges of the pad pattern. This clearance ensures the avoidance of shorting.

To improve the thermal performance of the package, use thermal vias on the PCB thermal pad. If vias are used, incorporate them into the thermal pad at the 1.2 mm pitch grid. The via diameter must be between 0.3 mm and 0.33 mm, and the via barrel must be plated with 1 oz. of copper to plug the via.

For a microwave PLL and VCO synthesizer, such as the ADF5355, take care with the board stack-up and layout. Do not consider using FR4 material because it is too lossy above 3 GHz. Instead, Rogers 4350, Rogers 4003, or Rogers 3003 dielectric material is suitable.

Take care with the RF output traces to minimize discontinuities and ensure the best signal integrity. Via placement and grounding are critical.

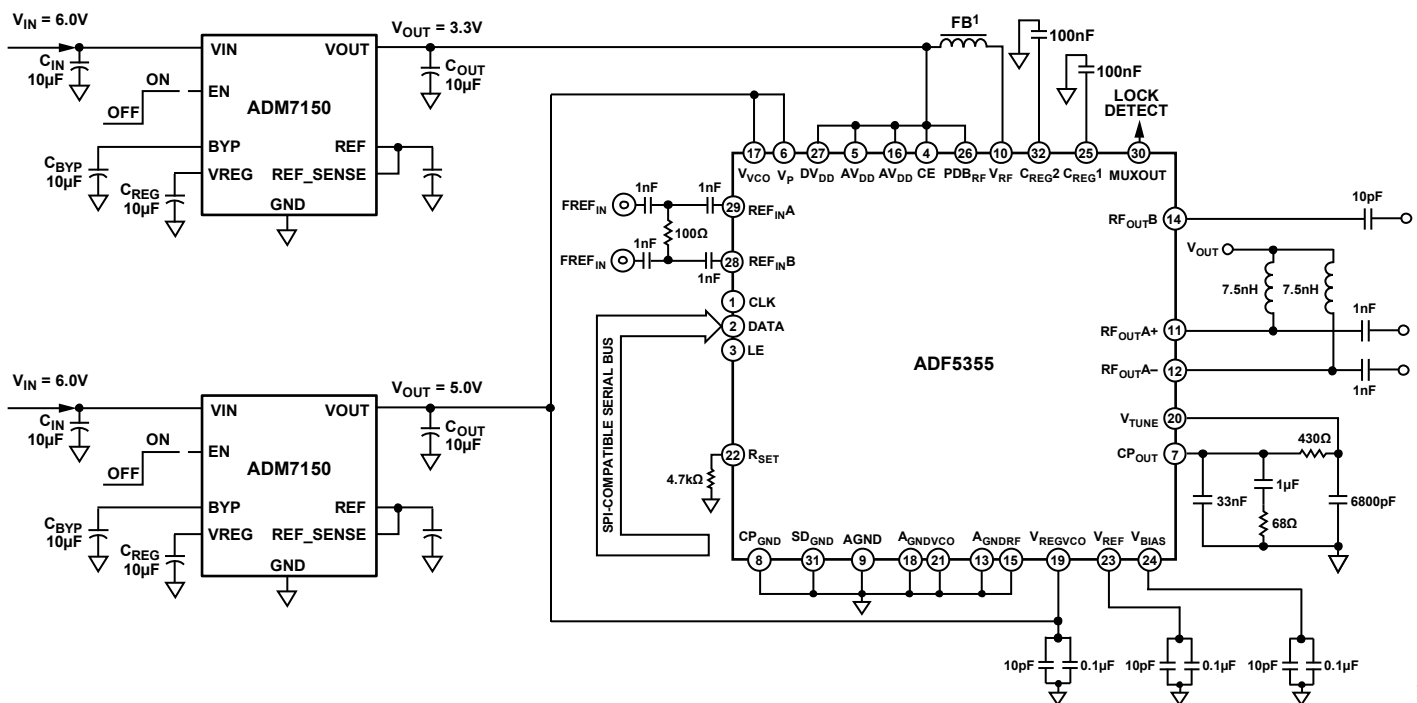

¹MURATA PART NUMBER BLM15AX100SN1D HAS BEEN USED WITH GOOD RESULTS.

Figure 55. ADF5355 Power Supplies

12714-050

OUTPUT MATCHING

The low frequency output can simply be ac-coupled to the next circuit, if desired; however, if higher output power is required, use a pull-up inductor to increase the output power level.

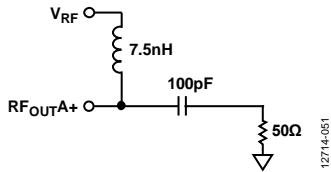

Figure 56. Optimum Output Stage

When differential outputs are not needed, terminate the unused output or combine it with both outputs using a balun.

For lower frequencies below 2 GHz, it is recommended to use a 100 nH inductor on the RF_{OUTA+}/RF_{OUTA-} pins.

The RF_{OUTA+}/RF_{OUTA-} pins are a differential circuit. Provide each output with the same (or similar) components where possible, such as same shunt inductor value, bypass capacitor, and termination.

AC couple the higher frequency output, RF_{OUTB}, directly to the next appropriate circuit stage.

RF_{OUTB} is matched internally to a 50 Ω impedance and requires no additional matching components.

OUTLINE DIMENSIONS

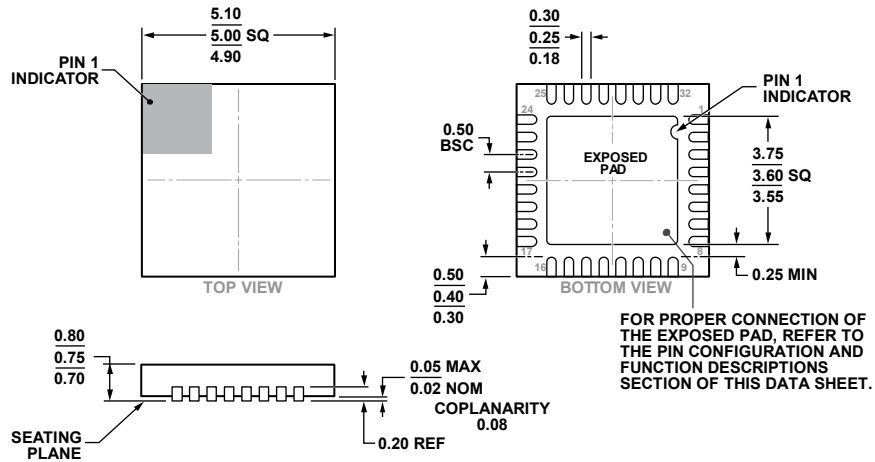

COMPLIANT TO JEDEC STANDARDS MO-220-WHHD-5.

Figure 57. 32-Lead Lead Frame Chip Scale Package [LFCSP_WQ]
5 mm × 5 mm Body, Very, Very Thin Quad
(CP-32-12)
Dimensions shown in millimeters

ORDERING GUIDE

| Model ¹ | Temperature Range | Package Description | Package Option |
|--------------------|-------------------|--|----------------|
| ADF5355BCPZ | -40°C to +85°C | 32-Lead Lead Frame Chip Scale Package [LFCSP_WQ] | CP-32-12 |
| ADF5355BCPZ-RL7 | -40°C to +85°C | 32-Lead Lead Frame Chip Scale Package [LFCSP_WQ] | CP-32-12 |
| EV-ADF5355SD1Z | | Evaluation Board | |

¹ Z = RoHS Compliant Part.