

## 阅读申明

- 1.本站收集的数据手册和产品资料都来自互联网，版权归原作者所有。如读者和版权方有任何异议请及时告之，我们将妥善解决。
- 2.本站提供的中文数据手册是英文数据手册的中文翻译，其目的是协助用户阅读，该译文无法自动跟随原稿更新，同时也可能存在翻译上的不当。建议读者以英文原稿为参考以便获得更精准的信息。
- 3.本站提供的产品资料，来自厂商的技术支持或者使用者的心得体会等，其内容可能存在描述上的差异，建议读者做出适当判断。
- 4.如需与我们联系，请发邮件到marketing@iczoom.com，主题请标有“数据手册”字样。

## Read Statement

1. The datasheets and other product information on the site are all from network reference or other public materials, and the copyright belongs to the original author and original published source. If readers and copyright owners have any objections, please contact us and we will deal with it in a timely manner.
2. The Chinese datasheets provided on the website is a Chinese translation of the English datasheets. Its purpose is for reader's learning exchange only and do not involve commercial purposes. The translation cannot be automatically updated with the original manuscript, and there may also be improper translations. Readers are advised to use the English manuscript as a reference for more accurate information.
3. All product information provided on the website refer to solutions from manufacturers' technical support or users the contents may have differences in description, and readers are advised to take the original article as the standard.
4. If you have any questions, please contact us at marketing@iczoom.com and mark the subject with "Datasheets" .

## DS1091L

# Automotive Temperature Range Spread-Spectrum EconOscillator™

### General Description

The DS1091L is a low-cost clock generator that is factory trimmed to output frequencies from 130kHz to 66.6MHz with a nominal accuracy of  $\pm 0.25\%$ . The device can also produce a center- or down-dithered spread-spectrum output with pin-selectable dither magnitude and rate. Assembled in an 8-pin  $\mu\text{MAX}^{\text{®}}$  package, the DS1091L is designed to operate with a 3.0V to 3.6V power supply over the automotive temperature range ( $-40^{\circ}\text{C}$  to  $+125^{\circ}\text{C}$ ).

### Applications

Automotive Infotainment  
POS Terminals  
LCD Displays  
Printers  
Industrial Control

### Typical Operating Circuit

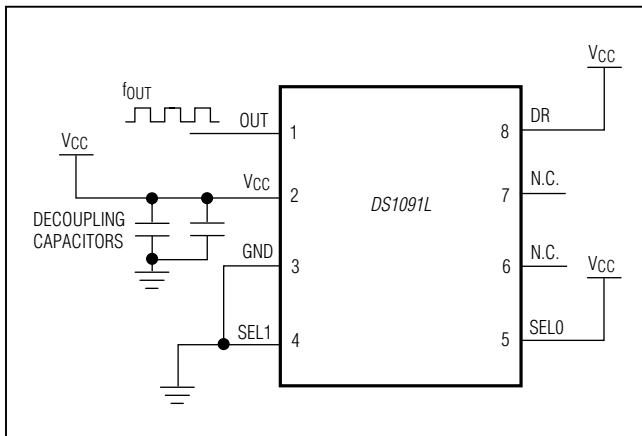

### Features

- ◆ Spread-Spectrum Clock Output from 130kHz to 66.6MHz
- ◆  $-40^{\circ}\text{C}$  to  $+125^{\circ}\text{C}$  Operating Temperature Range
- ◆  $\pm 1.75\%$  Accuracy Across Temperature and Voltage
- ◆ Factory Trimmed
- ◆ Center-Dithered (DS1091LUA) or Down-Dithered (DS1091LUB) Spread-Spectrum Output
- ◆ Pin-Selectable Center-Dither Magnitude of 0%,  $\pm 1\%$ ,  $\pm 2\%$ , or  $\pm 4\%$
- ◆ Pin-Selectable Down-Dither Magnitude of 0%,  $-2\%$ ,  $-4\%$ , or  $-8\%$
- ◆ Pin-Selectable Dither Rate
- ◆ 3.0V to 3.6V Supply Operation
- ◆ Lead(Pb)-Free, 8-Pin  $\mu\text{MAX}$  Package

### Custom Frequency Options

Custom frequency options are available. See the [Ordering Information](#) or contact the factory by email at [custom\\_oscillators@maximintegrated.com](mailto:custom_oscillators@maximintegrated.com) for more information.

[Ordering Information](#) appears at end of data sheet.

EconOscillator is a trademark and  $\mu\text{MAX}$  is a registered trademark of Maxim Integrated Products, Inc.

For related parts and recommended products to use with this part, refer to: [www.maximintegrated.com/DS1091L.related](http://www.maximintegrated.com/DS1091L.related)

For pricing, delivery, and ordering information, please contact Maxim Direct at 1-888-629-4642, or visit Maxim Integrated's website at [www.maximintegrated.com](http://www.maximintegrated.com).

# DS1091L

## Automotive Temperature Range Spread-Spectrum EconOscillator™

### ABSOLUTE MAXIMUM RATINGS

Voltage Range on  $V_{CC}$  Relative to Ground .....-0.5V to +6.0V  
Voltage Range on DR, SEL0, SEL1  
Relative to Ground.....-0.5V to ( $V_{CC} + 0.5V$ )\*  
Continuous Power Dissipation ( $T_A = +70^\circ\text{C}$ )  
 $\mu\text{MAX}$  (derate 4.5mW/ $^\circ\text{C}$  above +70 $^\circ\text{C}$ ) .....362mW

Operating Temperature Range .....-40 $^\circ\text{C}$  to +125 $^\circ\text{C}$   
Storage Temperature Range.....-55 $^\circ\text{C}$  to +125 $^\circ\text{C}$   
Lead Temperature (soldering, 10s) .....+300 $^\circ\text{C}$   
Soldering Temperature (reflow) .....+260 $^\circ\text{C}$

\*This voltage must not exceed 6.0V.

Stresses beyond those listed under "Absolute Maximum Ratings" may cause permanent damage to the device. These are stress ratings only, and functional operation of the device at these or any other conditions beyond those indicated in the operational sections of the specifications is not implied. Exposure to absolute maximum rating conditions for extended periods may affect device reliability.

### RECOMMENDED OPERATING CONDITIONS

( $T_A = -40^\circ\text{C}$  to +125 $^\circ\text{C}$ , unless otherwise noted.)

PARAMETER	SYMBOL	CONDITIONS	MIN	TYP	MAX	UNITS
Supply Voltage	$V_{CC}$	(Note 1)	3.0	3.3	3.6	V
High-Level Input Voltage (SEL0, SEL1, DR)	$V_{IH}$		0.7 x $V_{CC}$		$V_{CC} +$ 0.3	V
Low-Level Input Voltage (SEL0, SEL1, DR)	$V_{IL}$		-0.3		0.3 x $V_{CC}$	V

### DC ELECTRICAL CHARACTERISTICS

( $V_{CC} = +3.0V$  to +3.6V,  $T_A = -40^\circ\text{C}$  to +125 $^\circ\text{C}$ , unless otherwise noted.)

PARAMETER	SYMBOL	CONDITIONS	MIN	TYP	MAX	UNITS
High-Level Output Voltage (OUT)	$V_{OH}$	$I_{OH} = -4\text{mA}$ , $V_{CC} = 3.0V$	2.4			V
Low-Level Output Voltage (OUT)	$V_{OL}$	$I_{OL} = 4\text{mA}$			0.4	V
High-Level Input Current (SEL0, SEL1, DR)	$I_{IH}$	$V_{CC} = 3.6V$			1	$\mu\text{A}$
Low-Level Input Current (SEL0, SEL1, DR)	$I_{IL}$	$V_{IL} = 0V$	-1			$\mu\text{A}$
Supply Current (Active)	$I_{CC}$	(Note 2)			16	mA

# DS1091L

## Automotive Temperature Range Spread-Spectrum EconOscillator™

### AC ELECTRICAL CHARACTERISTICS

( $V_{CC} = +3.0V$  to  $+3.6V$ ,  $T_A = -40^{\circ}C$  to  $+125^{\circ}C$ , unless otherwise noted.)

PARAMETER	SYMBOL	CONDITIONS	MIN	TYP	MAX	UNITS
Output Frequency Range	$f_{OUT}$	(Note 3)	0.130		66.6	MHz
Output Center Frequency Tolerance	$\Delta f_{OUT}$	$V_{CC} = 3.3V$ , $T_A = +25^{\circ}C$	-0.25	0	+0.25	%
		Across $T_A$ and $V_{CC}$	-1.75		+1.75	
		$0^{\circ}C$ to $+70^{\circ}C$ , across $V_{CC}$	-1.2		+1.2	
Power-Up Time	$t_{PU}$	(Note 4)			0.1	ms
Load Capacitance	$C_L$			15	50	pF
Duty Cycle		< 33.3MHz (Note 3)		50		%
		$\geq 33.3MHz$ (Note 3)	40		60	
Jitter (RMS), 50MHz				0.3		%

**Note 1:** All voltages are referenced to ground. Currents entering the IC are specified positive and currents exiting the IC are negative.

**Note 2:** Supply current measured with  $C_L = 15pF$ ,  $V_{CC} = 3.6V$ ,  $T_A = +25^{\circ}C$ ,  $f_{OUT} = 66.6MHz$ , no dither.

**Note 3:** No dither.

**Note 4:** Guaranteed by design.

**Note 5:** For aging characteristics, contact factory.

### Typical Operating Characteristics

( $V_{CC} = 3.3V$ ,  $T_A = +25^{\circ}C$ , unless otherwise noted.)

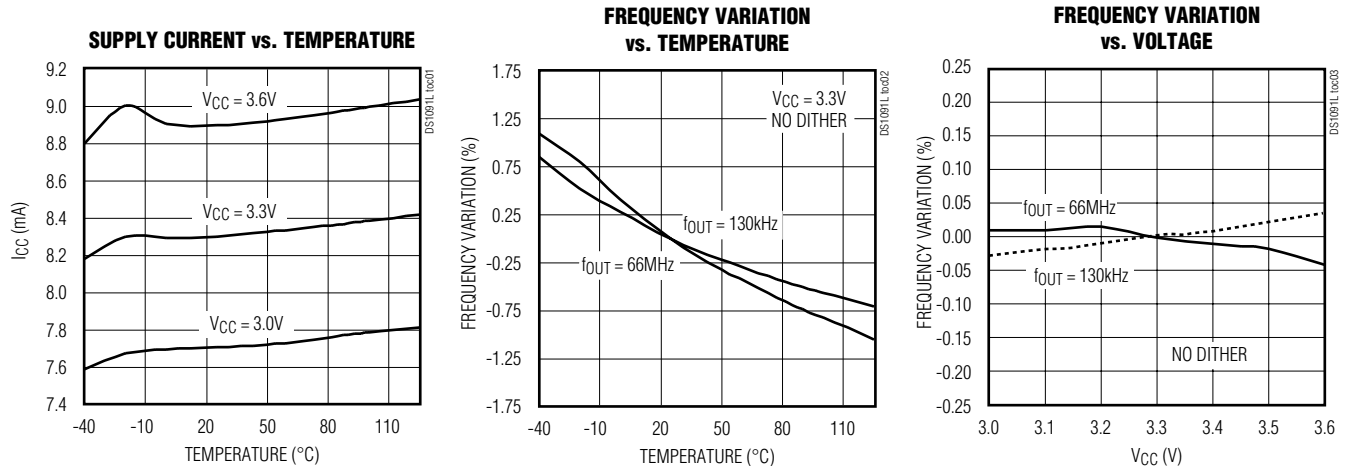

# DS1091L

## Automotive Temperature Range Spread-Spectrum EconOscillator™

### Typical Operating Characteristics (continued)

( $V_{CC} = 3.3V$ ,  $T_A = +25^\circ C$ , unless otherwise noted.)

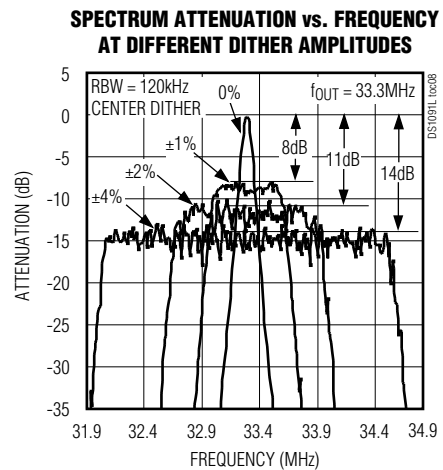
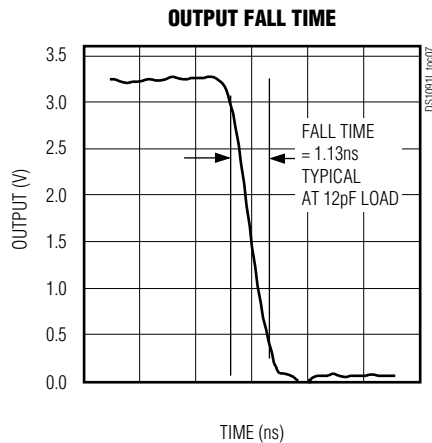
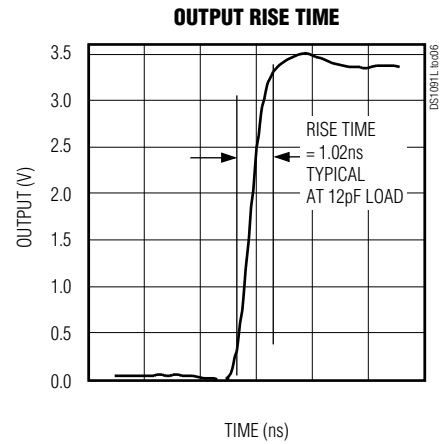
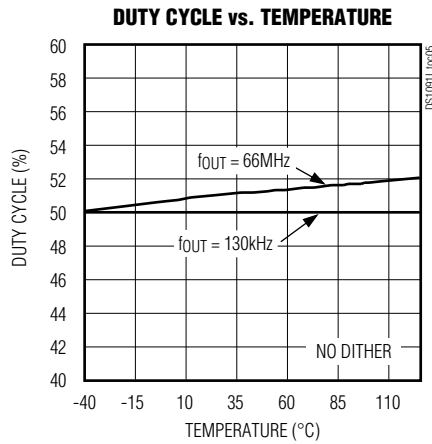
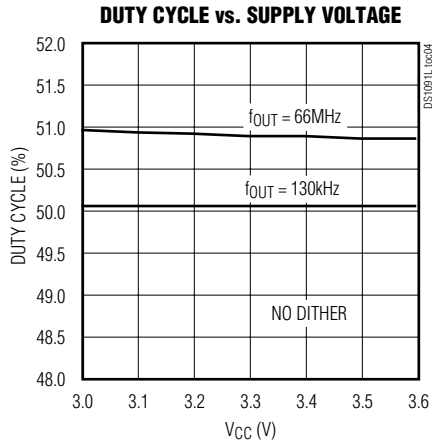

# DS1091L

## Automotive Temperature Range Spread-Spectrum EconOscillator™

### Pin Configuration

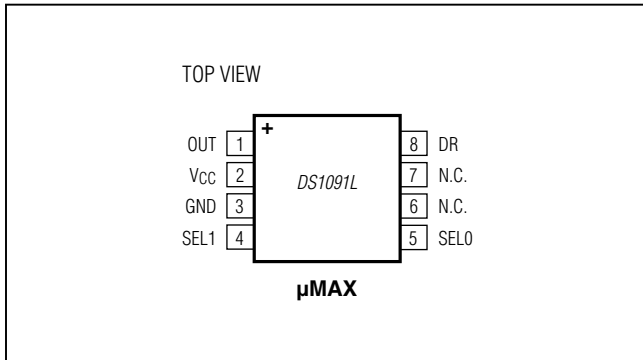

### Pin Description

PIN	NAME	FUNCTION
1	OUT	Spread-Spectrum Clock Output
2	V <sub>CC</sub>	Supply Voltage
3	GND	Ground
4	SEL1	Spread-Spectrum Dither Magnitude Select Inputs. Selects dither magnitude (see <a href="#">Table 1</a> ).
5	SEL0	
6, 7	N.C.	No Connection
8	DR	Spread-Spectrum Dither Rate Selector. Selects dither rate (see <a href="#">Table 2</a> ).

### Block Diagram

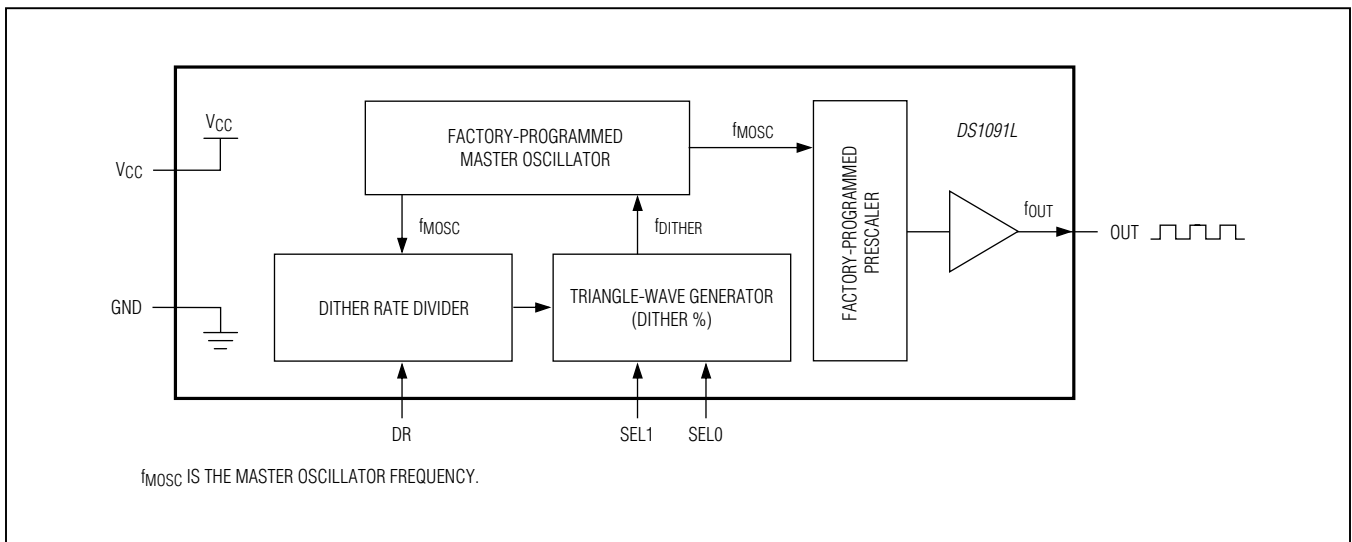

# DS1091L

## Automotive Temperature Range Spread-Spectrum EconOscillator™

### Detailed Description

The DS1091L clock generator is capable of output frequencies from 130kHz to 66.6MHz over the full automotive temperature range (-40°C to +125°C). The device can also produce a spread-spectrum (dithered) square-wave output using four pin-selectable dither percentages. Both center (DS1091LUA) and down (DS1091LUB) dithering options are available. The device also features two selectable dither rates.

The DS1091L is shipped from the factory programmed to a customer-specified frequency.

### Spread Spectrum

The DS1091L can reduce radiated emission peaks. The dither percentage is controlled by the state of the SEL0 and SEL1 pins. The output frequency can be dithered at 0%, ±1%, ±2%, and ±4%, centered around the programmed frequency (for the DS1091LUB this can be down dithered by 0%, -2%, -4%, and -8%).

The two select pins SEL0 and SEL1 provide a means of selecting the dither magnitudes as follows:

A triangle-wave generator injects a control signal into the master oscillator to dither its output. The dither rate is a function of the output frequency,  $f_{OUT}$ , as well as the setting of the DR pin (see the equation below). [Figure 1A](#) and [Figure 1B](#) show a plot of the output frequency vs. time.

$$\text{DITHER RATE} = \frac{f_{OUT}}{2^n}$$

where n is defined in [Table 2](#) as a function of output frequency. For example, for an output frequency of 27.0MHz, the dither rate would be 13.2kHz for DR = 1 and 6.6kHz for DR = 0.

### DS1091L Frequency Spreading Profile as a Function of Dither %

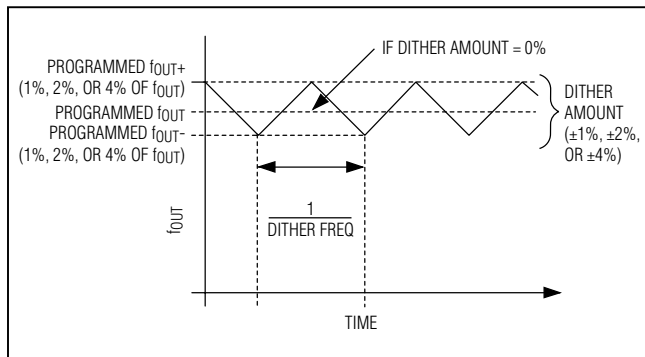

Figure 1A. Center Dithered

### Power-Up

Upon the application of power, the DS1091L output is held in the low state until  $t_{PU}$  has elapsed. This removes any possibility of erroneous output transitions during initial power-up.

Table 1. Dither Magnitude

SEL1 LOGIC LEVEL	SEL0 LOGIC LEVEL	DITHER MAGNITUDE (%)	
		DS1091LUA	DS1091LUB
0	0	No dither	No dither
0	1	±1	-2
1	0	±2	-4
1	1	±4	-8

Table 2. Value of n w.r.t. Output Frequency

OUTPUT FREQUENCY $f_{OUT}$ (MHz)		n	
$f_{OUT}$ (min)	$f_{OUT}$ (max)	DR = LOGIC LEVEL 1	DR = LOGIC LEVEL 0
0.130	0.260	4	5
0.261	0.521	5	6
0.522	1.042	6	7
1.043	2.083	7	8
2.084	4.167	8	9
4.168	8.333	9	10
8.334	16.667	10	11
16.668	33.333	11	12
33.334	66.667	12	13

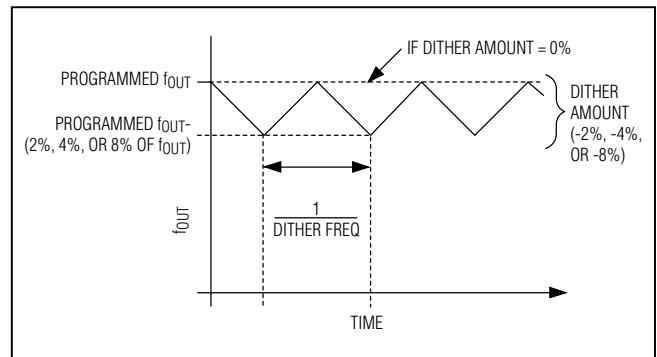

Figure 1B. Down Dithered

# DS1091L

## Automotive Temperature Range Spread-Spectrum EconOscillator™

### Applications Information

#### Power-Supply Decoupling

To achieve best results, it is highly recommended that decoupling capacitors are used on the IC power-supply pins. Typical values of decoupling capacitors are 0.01 $\mu$ F and 0.1 $\mu$ F. Use a high-quality, ceramic, surface-mount capacitor, and mount it as close as possible to the V<sub>CC</sub> and GND pins of the IC to minimize lead inductance.

### Chip Information

SUBSTRATE CONNECTED TO GROUND

### Package Information

For the latest package outline information and land patterns (footprints), go to [www.maximintegrated.com/packages](http://www.maximintegrated.com/packages). Note that a "+", "#", or "-" in the package code indicates RoHS status only. Package drawings may show a different suffix character, but the drawing pertains to the package regardless of RoHS status.

PACKAGE TYPE	PACKAGE CODE	OUTLINE NO.	LAND PATTERN NO.
8 $\mu$ MAX	U8+1	<a href="#">21-0036</a>	<a href="#">90-0092</a>

### Ordering Information

PART	TEMP RANGE	SPREAD SPECTRUM	OUTPUT FREQUENCY (MHz)	PIN-PACKAGE
DS1091LUA-027+	-40°C to +125°C	Center	27.0	8 $\mu$ MAX
DS1091LUA-027+T	-40°C to +125°C	Center	27.0	8 $\mu$ MAX
DS1091LUA-030/V+	-40°C to +125°C	Center	30.0	8 $\mu$ MAX
DS1091LUA-030/V+T	-40°C to +125°C	Center	30.0	8 $\mu$ MAX
DS1091LUA-033+	-40°C to +125°C	Center	33.3	8 $\mu$ MAX
DS1091LUA-033+T	-40°C to +125°C	Center	33.3	8 $\mu$ MAX
DS1091LUA-033/V+	-40°C to +125°C	Center	33.3	8 $\mu$ MAX
DS1091LUA-033/V+T	-40°C to +125°C	Center	33.3	8 $\mu$ MAX
DS1091LUA-040+	-40°C to +125°C	Center	40.0	8 $\mu$ MAX
DS1091LUA-040+T	-40°C to +125°C	Center	40.0	8 $\mu$ MAX
DS1091LUA-040/V+	-40°C to +125°C	Center	40.0	8 $\mu$ MAX
DS1091LUA-040/V+T	-40°C to +125°C	Center	40.0	8 $\mu$ MAX
DS1091LUA-055/V+	-40°C to +125°C	Center	55.4	8 $\mu$ MAX
DS1091LUA-055/V+T	-40°C to +125°C	Center	55.4	8 $\mu$ MAX
DS1091LUA-066+	-40°C to +125°C	Center	66.6	8 $\mu$ MAX
DS1091LUA-066+T	-40°C to +125°C	Center	66.6	8 $\mu$ MAX
DS1091LUA-066/V+	-40°C to +125°C	Center	66.6	8 $\mu$ MAX
DS1091LUA-066/V+T	-40°C to +125°C	Center	66.6	8 $\mu$ MAX
DS1091LUA-10A/V+	-40°C to +125°C	Center	10.38	8 $\mu$ MAX
DS1091LUA-10A/V+T	-40°C to +125°C	Center	10.38	8 $\mu$ MAX
DS1091LUA-172/V+	-40°C to +125°C	Center	1.7	8 $\mu$ MAX

*V* denotes an automotive qualified part.

+Denotes a lead(Pb)-free/RoHS-compliant package.

T = Tape and reel.

[Ordering Information](#) continued on next page.



# DS1091L

## Automotive Temperature Range Spread-Spectrum EconOscillator™

### *Ordering Information (continued)*

PART	TEMP RANGE	SPREAD SPECTRUM	OUTPUT FREQUENCY (MHz)	PIN-PACKAGE
DS1091LUA-172/V+T	-40°C to +125°C	Center	1.7	8 μMAX
DS1091LUA-190/V+	-40°C to +125°C	Center	1.9	8 μMAX
DS1091LUA-190/V+T	-40°C to +125°C	Center	1.9	8 μMAX
DS1091LUA-200+	-40°C to +125°C	Center	0.20	8 μMAX
DS1091LUA-200+T	-40°C to +125°C	Center	0.20	8 μMAX
DS1091LUA-200/V+	-40°C to +125°C	Center	0.20	8 μMAX
DS1091LUA-200/V+T	-40°C to +125°C	Center	0.20	8 μMAX
DS1091LUA-330+	-40°C to +125°C	Center	33.0	8 μMAX
DS1091LUA-330+T	-40°C to +125°C	Center	33.0	8 μMAX
DS1091LUA-330/V+	-40°C to +125°C	Center	33.0	8 μMAX
DS1091LUA-330/V+T	-40°C to +125°C	Center	33.0	8 μMAX
DS1091LUA-xxx+	-40°C to +125°C	Center	Custom (contact factory)	8 μMAX
DS1091LUB-008+T	-40°C to +125°C	Down	8.0	8 μMAX
DS1091LUB-016/V+	-40°C to +125°C	Down	16.6	8 μMAX
DS1091LUB-016/V+T	-40°C to +125°C	Down	16.6	8 μMAX
DS1091LUB-019/V+	-40°C to +125°C	Down	19.9	8 μMAX
DS1091LUB-019/V+T	-40°C to +125°C	Down	19.9	8 μMAX
DS1091LUB-025/V+	-40°C to +125°C	Down	25.0	8 μMAX
DS1091LUB-025/V+T	-40°C to +125°C	Down	25.0	8 μMAX
DS1091LUB-027+	-40°C to +125°C	Down	27.0	8 μMAX
DS1091LUB-027+T	-40°C to +125°C	Down	27.0	8 μMAX
DS1091LUB-027/V+	-40°C to +125°C	Down	27.0	8 μMAX
DS1091LUB-027/V+T	-40°C to +125°C	Down	27.0	8 μMAX
DS1091LUB-033+	-40°C to +125°C	Down	33.3	8 μMAX
DS1091LUB-033+T	-40°C to +125°C	Down	33.3	8 μMAX
DS1091LUB-066+	-40°C to +125°C	Down	66.6	8 μMAX
DS1091LUB-066+T	-40°C to +125°C	Down	66.6	8 μMAX
DS1091LUB-xxx+	-40°C to +125°C	Down	Custom (contact factory)	8 μMAX

*V* denotes an automotive qualified part.

*+* Denotes a lead(Pb)-free/RoHS-compliant package.

*T* = Tape and reel.

*xxx* Denotes factory-programmed custom frequencies. Email [custom.oscillators@maximintegrated.com](mailto:custom.oscillators@maximintegrated.com) for more information.

# DS1091L

## Automotive Temperature Range Spread-Spectrum EconOscillator™

### Revision History

REVISION NUMBER	REVISION DATE	DESCRIPTION	PAGES CHANGED
0	9/06	Initial release	—
1	3/11	Added the continuous power dissipation numbers, lead temperature, and soldering temperature to the <i>Absolute Maximum Ratings</i> section; updated the custom frequency technical support information; updated the <i>Ordering Information</i> table; added the land pattern no. to the <i>Package Information</i> table	1, 2, 7
2	9/11	Updated the <i>Ordering Information</i> table	7
3	6/13	Updated the <i>Ordering Information</i> table (adding rows)	7, 8



Maxim Integrated cannot assume responsibility for use of any circuitry other than circuitry entirely embodied in a Maxim Integrated product. No circuit patent licenses are implied. Maxim Integrated reserves the right to change the circuitry and specifications without notice at any time. The parametric values (min and max limits) shown in the Electrical Characteristics table are guaranteed. Other parametric values quoted in this data sheet are provided for guidance.