

阅读申明

- 1.本站收集的数据手册和产品资料都来自互联网，版权归原作者所有。如读者和版权方有任何异议请及时告之，我们将妥善解决。
- 2.本站提供的中文数据手册是英文数据手册的中文翻译，其目的是协助用户阅读，该译文无法自动跟随原稿更新，同时也可能存在翻译上的不当。建议读者以英文原稿为参考以便获得更精准的信息。
- 3.本站提供的产品资料，来自厂商的技术支持或者使用者的心得体会等，其内容可能存在描述上的差异，建议读者做出适当判断。
- 4.如需与我们联系，请发邮件到marketing@iczoom.com，主题请标有“数据手册”字样。

Read Statement

1. The datasheets and other product information on the site are all from network reference or other public materials, and the copyright belongs to the original author and original published source. If readers and copyright owners have any objections, please contact us and we will deal with it in a timely manner.
2. The Chinese datasheets provided on the website is a Chinese translation of the English datasheets. Its purpose is for reader's learning exchange only and do not involve commercial purposes. The translation cannot be automatically updated with the original manuscript, and there may also be improper translations. Readers are advised to use the English manuscript as a reference for more accurate information.
3. All product information provided on the website refer to solutions from manufacturers' technical support or users the contents may have differences in description, and readers are advised to take the original article as the standard.
4. If you have any questions, please contact us at marketing@iczoom.com and mark the subject with "Datasheets" .

P3P623S05A/B, P3P623S09A/B

Timing-Safe™ Peak EMI Reduction IC

Functional Description

P3P623S05/09 is a versatile, 3.3 V Zero-delay buffer designed to distribute Timing-Safe clocks with Peak EMI reduction. P3P623S05 is an eight-pin version, accepts one reference input and drives out five low-skew Timing-Safe clocks. P3P623S09 accepts one reference input and drives out nine low-skew Timing-Safe clocks.

All parts have on-chip PLL that locks to an input clock on the CLKIN pin. The PLL feedback is on-chip and is obtained from the CLKOUT pad, internal to the device.

Multiple P3P623S05 / P3P623S09 devices can accept the same input clock and distribute it. In this case, the skew between the outputs of the two devices is guaranteed to be less than 700 pS.

All outputs have less than 200 pS of cycle-to-cycle jitter. The input and output propagation delay is guaranteed to be less than ± 350 pS, and the output-to-output skew is guaranteed to be less than 250 pS.

Refer “Spread Spectrum Control and Input-Output Skew Table” for deviations and Input-Output Skew for P3P623S05A/B and P3P623S09A/B devices.

P3P623S05/09 operates from a 3.3 V supply and is available in TSSOP package, as shown in the ordering information table.

Application

P3P623S05/09 is targeted for use in Displays and memory interface systems.

General Features

- Clock Distribution with Timing-Safe Peak EMI Reduction
- Input Frequency Range: 20 MHz – 50 MHz
- Multiple Low Skew Timing-Safe Outputs:
 - ◆ P3P623S05: 5 Outputs
 - ◆ P3P623S09: 9 Outputs
- Supply Voltage: 3.3 V \pm 0.3 V
- Packaging Information:
 - ◆ P3P623S05: 8 Pin TSSOP
 - ◆ P3P623S09: 16 Pin TSSOP
- True Drop-in Solution for Zero Delay Buffer
- These Devices are Pb-Free, Halogen Free/BFR Free and are RoHS Compliant



ON Semiconductor®

www.onsemi.com

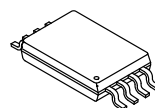

TSSOP8 4.4x3
CASE 948AL

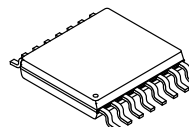

TSSOP16 4.4x5
CASE 948AN

ORDERING INFORMATION

See detailed ordering and shipping information in the package dimensions section on page 6 of this data sheet.

Spread Spectrum Frequency Generation

The clocks in digital systems are typically square waves with a 50% duty cycle and as frequencies increase the edge rates also get faster. Analysis shows that a square wave is composed of fundamental frequency and harmonics. The fundamental frequency and harmonics generate the energy peaks that become the source of EMI. Regulatory agencies test electronic equipment by measuring the amount of peak energy radiated from the equipment. In fact, the peak level allowed decreases as the frequency increases. The standard methods of reducing EMI are to use shielding, filtering, multi-layer PCBs, etc. These methods are expensive. Spread spectrum clocking reduces the peak energy by reducing the Q factor of the clock. This is done by slowly modulating the clock frequency. The P3P623S05/09 uses the center modulation spread spectrum technique in which the modulated output frequency varies above and below the reference frequency with a specified modulation rate. With center modulation, the average frequency is the same as the unmodulated frequency and there is no performance degradation.

Timing-Safe Technology

Timing-Safe technology is the ability to modulate a clock source with Spread Spectrum technology and maintain synchronization with any associated data path.

P3P623S05A/B, P3P623S09A/B

BLOCK DIAGRAM

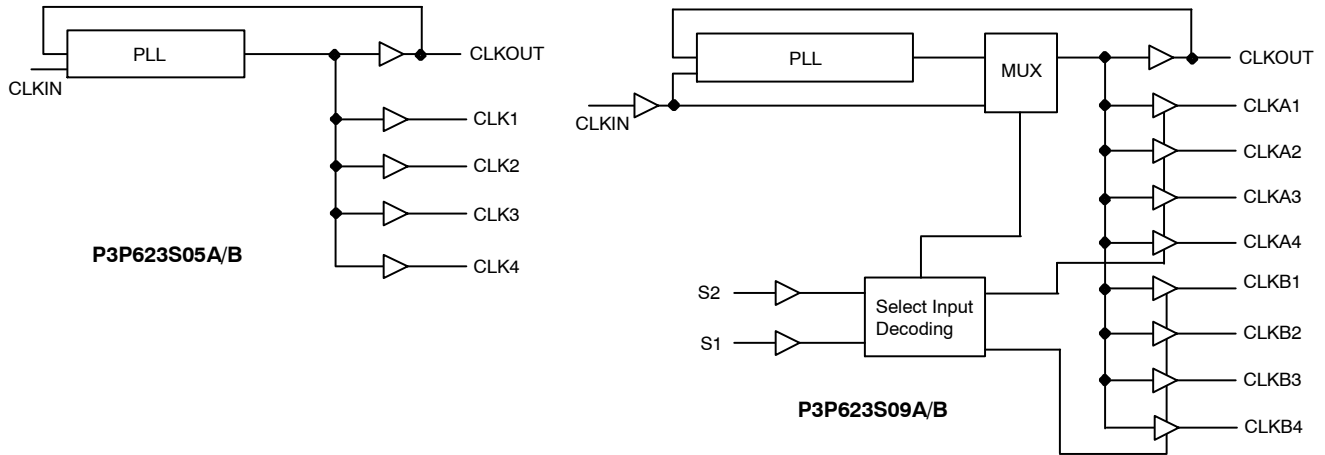

Figure 1. General Block Diagram

PIN CONFIGURATION

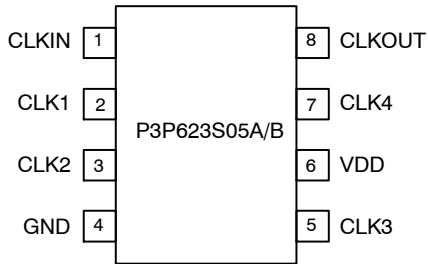

Figure 2. Pin Configuration for P3P623S05A/B

Table 1. PIN DESCRIPTION FOR P3P623S05A/B

Pin #	Pin Name	Type	Description
1	CLKIN (Note 1)	I	External reference Clock input, 5 V tolerant input.
2	CLK1 (Note 2)	O	Buffered clock output (Note 3)
3	CLK2 (Note 2)	O	Buffered clock output (Note 3)
4	GND	P	Ground
5	CLK3 (Note 2)	O	Buffered clock output (Note 3)
6	VDD	P	3.3 V supply
7	CLK4 (Note 2)	O	Buffered clock output (Note 3)
8	CLKOUT (Note 3)	O	Buffered clock output. Internal feedback on this pin.

1. Weak pull-down
2. Weak pull-down on all outputs
3. Buffered clock output is Timing-Safe

P3P623S05A/B, P3P623S09A/B

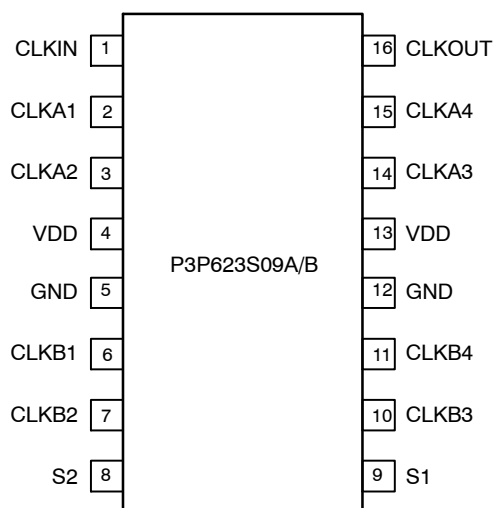

Figure 3. Pin Configuration for P3P623S09A/B

Table 2. PIN DESCRIPTION FOR P3P623S05A/B

Pin #	Pin Name	Type	Description
1	CLKIN (Note 1)	I	External reference Clock input, 5 V tolerant input.
2	CLKA1 (Note 2)	O	Buffered clock Bank A output (Note 4)
3	CLKA2 (Note 2)	O	Buffered clock Bank A output (Note 4)
4	VDD	P	3.3 V supply
5	GND	P	Ground
6	CLKB1 (Note 2)	O	Buffered clock Bank B output (Note 4)
7	CLKB2 (Note 2)	O	Buffered clock Bank B output (Note 4)
8	S2 (Note 3)	I	Select input, bit 2. See Select Input Decoding table for P3P623S09A/B for more details.
9	S1 (Note 3)	I	Select input, bit 1. See Select Input Decoding table for P3P623S09A/B for more details.
10	CLKB3 (Note 2)	O	Buffered clock Bank B output (Note 4)
11	CLKB4 (Note 2)	O	Buffered clock Bank B output (Note 4)
12	GND	P	Ground
13	VDD	P	3.3 V supply
14	CLKA3 (Note 2)	O	Buffered clock Bank A output (Note 4)
15	CLKA4 (Note 2)	O	Buffered clock Bank A output (Note 4)
16	CLKOUT (Note 2)	O	Buffered clock output. Internal feedback on this pin.

1. Weak pull-down
2. Weak pull-down on all outputs
3. Weak pull-up on these inputs
4. Buffered clock output is Timing-Safe

Table 3. SELECT INPUT DECODING TABLE FOR P3P623S09A/B

S2	S1	CLK A1 – A4	CLK B1 – B4	CLKOUT (Note 5)	Output Source	PLL Shut-Down
0	0	Three-state	Three-state	Driven	PLL	N
0	1	Driven	Three-state	Driven	PLL	N
1	0	Driven	Driven	Driven	Reference	Y
1	1	Driven	Driven	Driven	PLL	N

5. This output is driven and has an internal feedback for the PLL. The load on this output can be adjusted to change the skew between the reference and the Output.

P3P623S05A/B, P3P623S09A/B

Table 4. SPREAD SPECTRUM CONTROL AND INPUT-OUTPUT SKEW TABLE

Frequency (MHz)	Device	Deviation	Input-Output Skew ($\pm T_{SKEW}$)
32	P3P623S05A / 09A	$\pm 0.25\%$	0.125
	P3P623S05B / 09B	$\pm 0.50\%$	0.25

NOTE: T_{SKEW} is measured in units of the Clock Period

Table 5. ABSOLUTE MAXIMUM RATINGS

Symbol	Parameter	Rating	Unit
VDD	Supply Voltage to Ground Potential	-0.5 to +4.6	V
VIN	DC Input Voltage (CLKIN)	-0.5 to +7	
T_{STG}	Storage temperature	-65 to +125	°C
T_s	Max. Soldering Temperature (10 sec)	260	°C
T_J	Junction Temperature	150	°C
T_{DV}	Static Discharge Voltage (As per JEDEC STD22- A114-B)	2	KV

Stresses exceeding those listed in the Maximum Ratings table may damage the device. If any of these limits are exceeded, device functionality should not be assumed, damage may occur and reliability may be affected.

Table 6. OPERATING CONDITIONS

Parameter	Description	Min	Max	Unit
VDD	Supply Voltage	3.0	3.6	V
T_A	Operating Temperature (Ambient Temperature)	-40	+85	°C
C_L	Load Capacitance		30	pF
C_{IN}	Input Capacitance		7	pF

Table 7. ELECTRICAL CHARACTERISTICS

Parameter	Description	Test Conditions	Min	Typ	Max	Units
V_{IL}	Input LOW Voltage (Note 1)				0.8	V
V_{IH}	Input HIGH Voltage (Note 1)		2.0			V
I_{IL}	Input LOW Current	$V_{IN} = 0\text{ V}$			50	μA
I_{IH}	Input HIGH Current	$V_{IN} = V_{DD}$			100	μA
V_{OL}	Output LOW Voltage (Note 2)	$I_{OL} = 8\text{ mA}$			0.4	V
V_{OH}	Output HIGH Voltage (Note 2)	$I_{OH} = -8\text{ mA}$	2.4			V
I_{DD}	Supply Current	Unloaded outputs		15		mA
Z_O	Output Impedance			23		Ω

Product parametric performance is indicated in the Electrical Characteristics for the listed test conditions, unless otherwise noted. Product performance may not be indicated by the Electrical Characteristics if operated under different conditions.

1. CLKIN input has a threshold voltage of $V_{DD}/2$
2. Parameter is guaranteed by design and characterization. Not tested in production.

Table 8. SWITCHING CHARACTERISTICS

Parameter	Description	Test Conditions	Min	Typ	Max	Units
	Input Frequency		20		50	MHz
$1/t_1$	Output Frequency	30 pF load	20		50	MHz
t_D	Duty Cycle (Notes 3, 4) = $(t_2/t_1) * 100$	Measured at $V_{DD}/2$	40	50	60	%
t_3	Output Rise Time (Notes 3, 4)	Measured between 0.8 V and 2.0 V			2.5	nS
t_4	Output Fall Time (Notes 3, 4)	Measured between 2.0 V and 0.8 V			2.5	nS
t_5	Output-to-output skew (Notes 3, 4)	All outputs equally loaded			250	pS
t_6	Delay, CLKIN Rising Edge to CLKOUT Rising Edge (Note 4)	Measured at $V_{DD}/2$			± 350	pS
t_7	Device-to-Device Skew (Note 4)	Measured at $V_{DD}/2$ on the CLKOUT pins of the device			700	pS
t_J	Cycle-to-cycle jitter (Notes 3, 4)	Loaded outputs			± 200	pS
t_{LOCK}	PLL Lock Time (Note 4)	Stable power supply, valid clock presented on CLKIN pin			1.0	mS

3. All parameters specified with 30 pF loaded outputs.

4. Parameter is guaranteed by design and characterization. Not tested in production.

Switching Waveforms

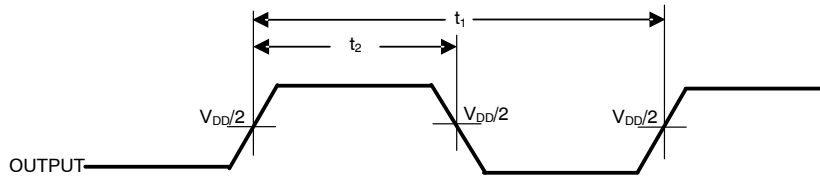

Figure 4. Duty Cycle Timing

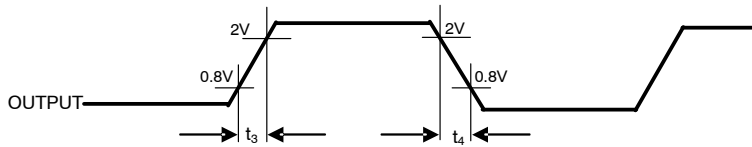

Figure 5. All Outputs Rise/Fall Time

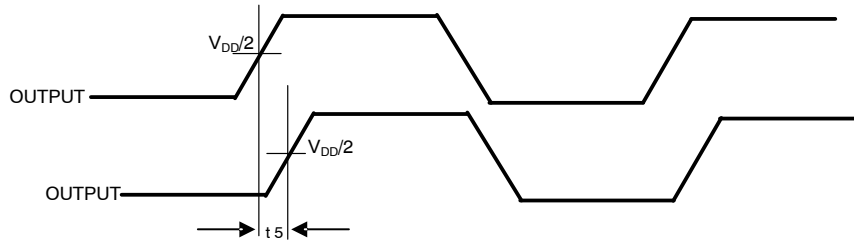

Figure 6. Output-Output Skew

P3P623S05A/B, P3P623S09A/B

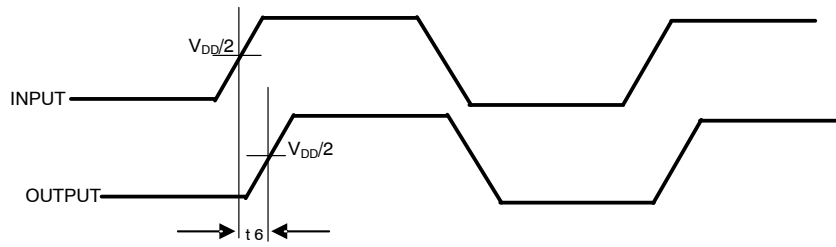

Figure 7. Input-Output Propagation Delay

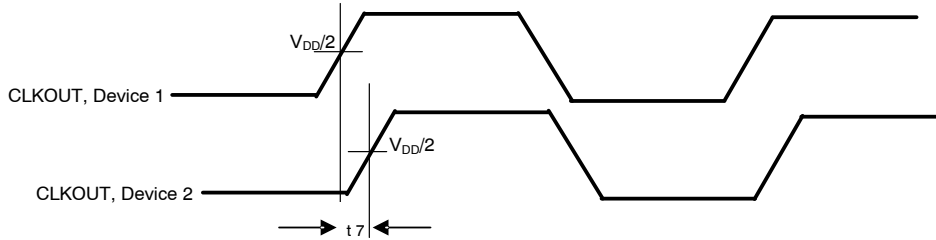

Figure 8. Device-Device Skew

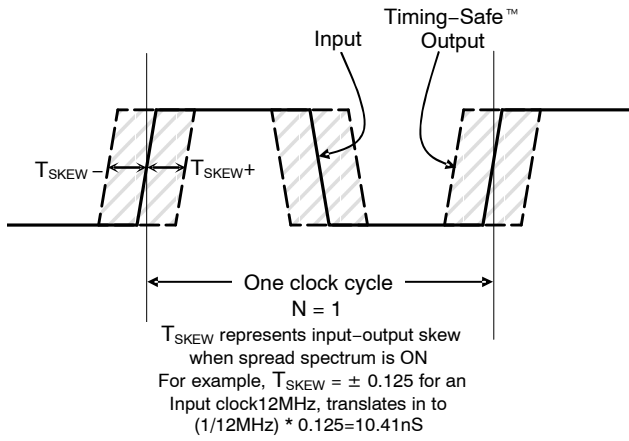

Figure 9. Input-Output Skew

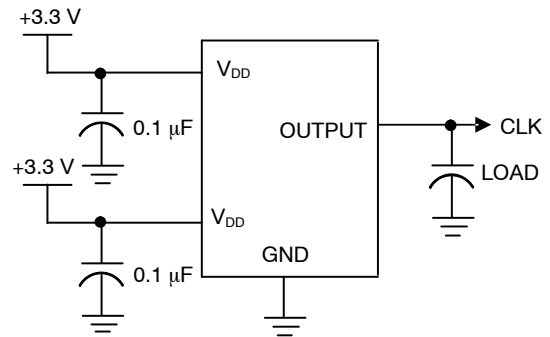

Figure 10. Test Circuit

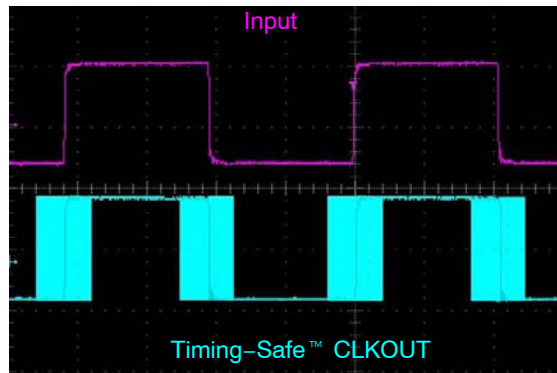
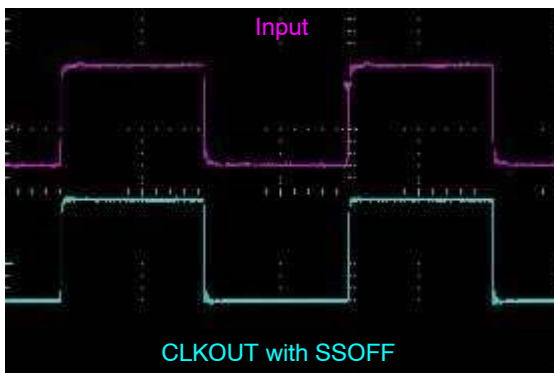

Figure 11. Typical Example of Timing-Safe Waveform

Table 9. ORDERING INFORMATION

Part Number	Marking	Package Type	Temperature
P3P623S05BG-08TR	ADQ	8 pin, 4.4 mm TSSOP, Tape & Reel, Green	0°C to +70°C

NOTE: A "microdot" placed at the end of last row of marking or just below the last row toward the center of package indicates Pb-free

P3P623S05A/B, P3P623S09A/B

PACKAGE DIMENSIONS

TSSOP8, 4.4x3
CASE 948AL
ISSUE O

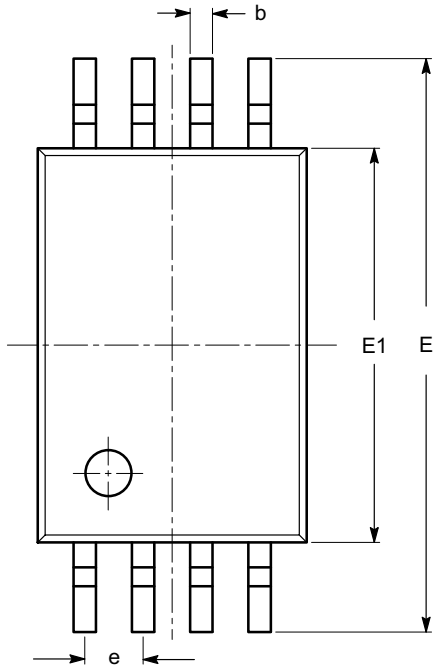

SYMBOL	MIN	NOM	MAX
A			1.20
A1	0.05		0.15
A2	0.80	0.90	1.05
b	0.19		0.30
c	0.09		0.20
D	2.90	3.00	3.10
E	6.30	6.40	6.50
E1	4.30	4.40	4.50
e	0.65 BSC		
L	1.00 REF		
L1	0.50	0.60	0.75
θ	0°		8°

TOP VIEW

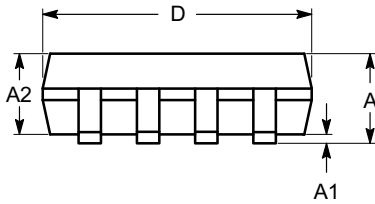

SIDE VIEW

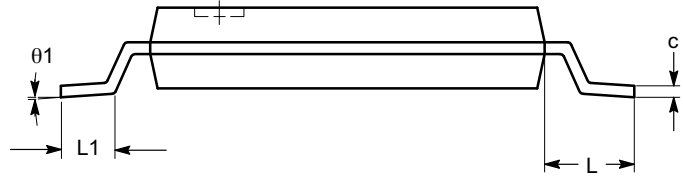

END VIEW

Notes:

- (1) All dimensions are in millimeters. Angles in degrees.
- (2) Complies with JEDEC MO-153.

P3P623S05A/B, P3P623S09A/B

PACKAGE DIMENSIONS

TSSOP16, 4.4x5
CASE 948AN
ISSUE O

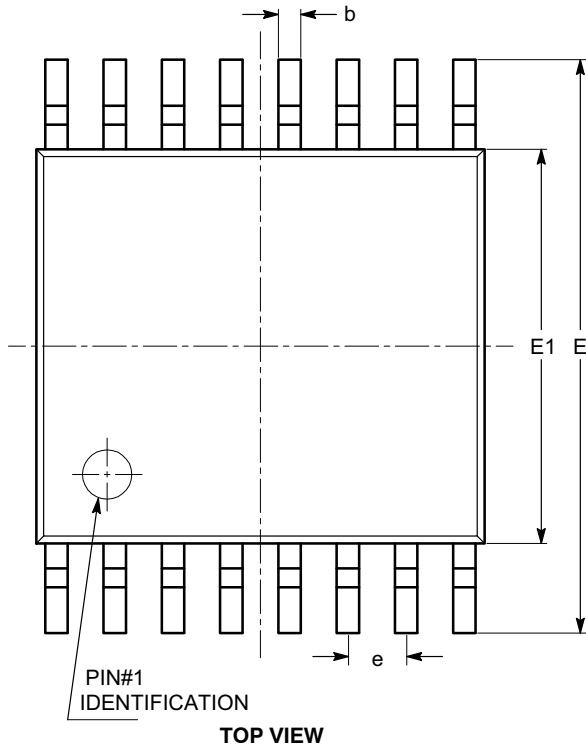

SYMBOL	MIN	NOM	MAX
A			1.10
A1	0.05		0.15
A2	0.85		0.95
b	0.19		0.30
c	0.13		0.20
D	4.90		5.10
E	6.30		6.50
E1	4.30		4.50
e	0.65 BSC		
L	1.00 REF		
L1	0.45		0.75
θ	0°		8°

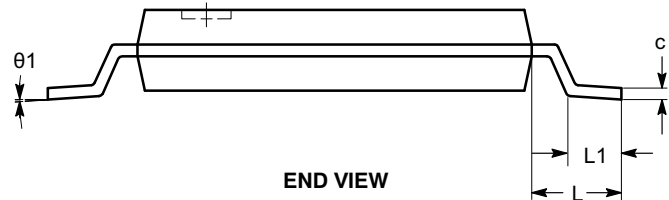
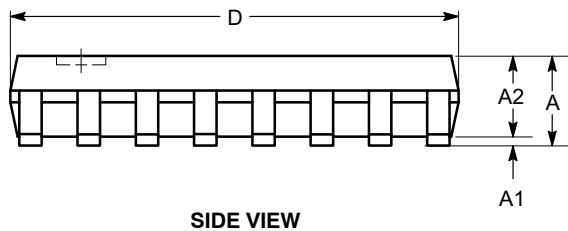

Notes:

- (1) All dimensions are in millimeters. Angles in degrees.
- (2) Complies with JEDEC MO-153.

TIMING SAFE is a trademark of Semiconductor Components Industries, LLC (SCILLC) or its subsidiaries in the United States and/or other countries.

ON Semiconductor and the  are registered trademarks of Semiconductor Components Industries, LLC (SCILLC) or its subsidiaries in the United States and/or other countries. SCILLC owns the rights to a number of patents, trademarks, copyrights, trade secrets, and other intellectual property. A listing of SCILLC's product/patent coverage may be accessed at www.onsemi.com/site/pdf/Patent-Marking.pdf. SCILLC reserves the right to make changes without further notice to any products herein. SCILLC makes no warranty, representation or guarantee regarding the suitability of its products for any particular purpose, nor does SCILLC assume any liability arising out of the application or use of any product or circuit, and specifically disclaims any and all liability, including without limitation special, consequential or incidental damages. "Typical" parameters which may be provided in SCILLC data sheets and/or specifications can and do vary in different applications and actual performance may vary over time. All operating parameters, including "Typicals" must be validated for each customer application by customer's technical experts. SCILLC does not convey any license under its patent rights nor the rights of others. SCILLC products are not designed, intended, or authorized for use as components in systems intended for surgical implant into the body, or other applications intended to support or sustain life, or for any other application in which the failure of the SCILLC product could create a situation where personal injury or death may occur. Should Buyer purchase or use SCILLC products for any such unintended or unauthorized application, Buyer shall indemnify and hold SCILLC and its officers, employees, subsidiaries, affiliates, and distributors harmless against all claims, costs, damages, and expenses, and reasonable attorney fees arising out of, directly or indirectly, any claim of personal injury or death associated with such unintended or unauthorized use, even if such claim alleges that SCILLC was negligent regarding the design or manufacture of the part. SCILLC is an Equal Opportunity/Affirmative Action Employer. This literature is subject to all applicable copyright laws and is not for resale in any manner.

PUBLICATION ORDERING INFORMATION

LITERATURE FULFILLMENT:
Literature Distribution Center for ON Semiconductor
P.O. Box 5163, Denver, Colorado 80217 USA
Phone: 303-675-2175 or 800-344-3860 Toll Free USA/Canada
Fax: 303-675-2176 or 800-344-3867 Toll Free USA/Canada
Email: orderlit@onsemi.com

N. American Technical Support: 800-282-9855 Toll Free
USA/Canada
Europe, Middle East and Africa Technical Support:
Phone: 421 33 790 2910
Japan Customer Focus Center
Phone: 81-3-5817-1050

ON Semiconductor Website: www.onsemi.com
Order Literature: <http://www.onsemi.com/orderlit>
For additional information, please contact your local Sales Representative