

阅读申明

- 1.本站收集的数据手册和产品资料都来自互联网，版权归原作者所有。如读者和版权方有任何异议请及时告之，我们将妥善解决。
- 2.本站提供的中文数据手册是英文数据手册的中文翻译，其目的是协助用户阅读，该译文无法自动跟随原稿更新，同时也可能存在翻译上的不当。建议读者以英文原稿为参考以便获得更精准的信息。
- 3.本站提供的产品资料，来自厂商的技术支持或者使用者的心得体会等，其内容可能存在描述上的差异，建议读者做出适当判断。
- 4.如需与我们联系，请发邮件到marketing@iczoom.com，主题请标有“数据手册”字样。

Read Statement

1. The datasheets and other product information on the site are all from network reference or other public materials, and the copyright belongs to the original author and original published source. If readers and copyright owners have any objections, please contact us and we will deal with it in a timely manner.
2. The Chinese datasheets provided on the website is a Chinese translation of the English datasheets. Its purpose is for reader's learning exchange only and do not involve commercial purposes. The translation cannot be automatically updated with the original manuscript, and there may also be improper translations. Readers are advised to use the English manuscript as a reference for more accurate information.
3. All product information provided on the website refer to solutions from manufacturers' technical support or users the contents may have differences in description, and readers are advised to take the original article as the standard.
4. If you have any questions, please contact us at marketing@iczoom.com and mark the subject with "Datasheets" .

Low Power 3 Output XO

FEATURES

- 3 LVCMOS outputs with OE tri-state control
- Low current consumption:
 - <math><4.5\text{mA}</math> @ 27MHz, 3.3V
- 10 to 52MHz fundamental crystal input
- 1 to 100MHz reference clock input
- Accepts both LVCMOS and sine wave inputs
- Low phase noise (-130 dBc @ 10kHz offset)
- Low jitter (RMS): 2.5ps period jitter
- 12mA drive capability at TTL output
- 1.8V to 3.3V operation
- Available in GREEN/RoHS 8-pin SOP and 6-pin SOT23 packages

PIN ASSIGNMENT

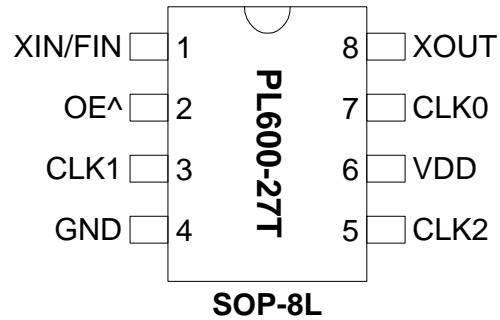

^: Denotes internal Pull-up

DESCRIPTION

The PL600-27T is a low cost XO IC, designed to replace multiple XO solutions saving the cost and board space of clock distribution buffers. In addition, it provides among the lowest current on the market for the 10MHz to 52MHz range. The PL600-27T accepts crystal and clock inputs from 10 to 52MHz (fundamental resonant mode crystal) and provides low phase noise (<math><-130\text{dBc}</math> at 10kHz offset at 30MHz), and very low jitter (2.5 ps RMS period jitter) outputs.

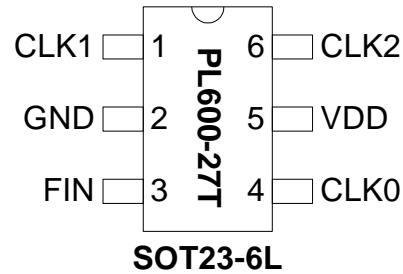

BLOCK DIAGRAM

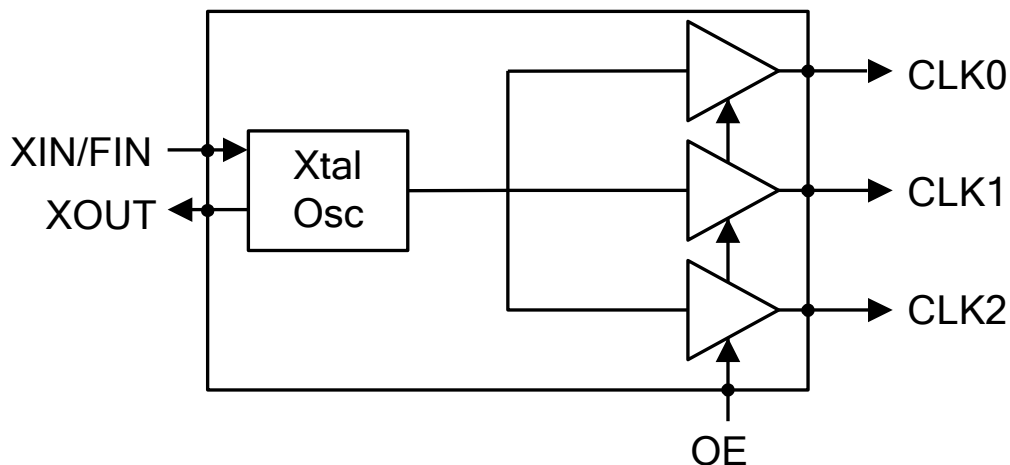

PIN DESCRIPTION

Name	Package Pin Number		Type	Description
	SOP-8L	SOT23-6L		
XIN/FIN	1	3 (FIN Only)	I	Crystal input (10MHz to 52MHz) or Ref Clock input (1MHz to 100MHz)
OE	2	-	I	Output Enable input. This pin has internal pull-up resistor. All outputs will be tri-stated when low.
CLK1	3	1	O	Output clock.
GND	4	2	P	Ground.
CLK2	5	6	O	Output clock.
VDD	6	5	P	Power supply.
CLK0	7	4	O	Output clock.
XOUT	8	-	I	Crystal output.

ELECTRICAL SPECIFICATIONS

1. Absolute Maximum Ratings

PARAMETERS	SYMBOL	MIN.	MAX.	UNITS
Supply Voltage	V_{DD}		4.6	V
Input Voltage, dc	V_I	-0.5	$V_{DD}+0.5$	V
Output Voltage, dc	V_O	-0.5	$V_{DD}+0.5$	V
Storage Temperature	T_S	-65	150	°C
Ambient Operating Temperature*	T_A	-40	85	°C
Junction Temperature	T_J		125	°C
Lead Temperature (soldering, 10s)			260	°C
ESD Protection, Human Body Model			2	kV

Exposure of the device under conditions beyond the limits specified by Maximum Ratings for extended periods may cause permanent damage to the device and affect product reliability. These conditions represent a stress rating only, and functional operations of the device at these or any other conditions above the operational limits noted in this specification is not implied. *Operating temperature is guaranteed by design. Parts are tested to commercial grade only.

Low Power 3 Output XO
2. AC Electrical Specifications

PARAMETERS	CONDITIONS	MIN.	TYP.	MAX.	UNITS
Input Crystal Frequency		10		52	MHz
Input (FIN) Frequency	LVC MOS or Sine Wave input	1		100	MHz
Input (FIN) Signal Amplitude	Internally AC coupled (High Frequency)	0.5		V _{DD}	V _{pp}
Input (FIN) Signal Amplitude	Internally AC coupled (Low Frequency) 3.3V ≤ 50MHz, 2.5V ≤ 40MHz, 1.8V ≤ 15MHz	0.1		V _{DD}	V _{pp}
Settling Time	At power-up (V _{DD} ≤ 1.62V)			10	ms
Output Clock Rise/Fall Time	0.8V ~ 2.0V with 10 pF load		1.15		ns
	0.3V ~ 3.0V with 15 pF load		2.4		
VDD sensitivity	Frequency vs. V _{DD} +/- 10%	0.8		0.8	ppm
Output Clock Duty Cycle	Measured @ 50% V _{DD}	45	50	55	%
Short Circuit Current			±50		mA

3. Jitter and Phase Noise Specifications

PARAMETERS	CONDITIONS	MIN.	TYP.	MAX.	UNITS
RMS Period Jitter (1 sigma – 1000 samples)	With capacitive decoupling between V _{DD} and GND.		2.1	2.5	ps
Phase Noise relative to carrier	30MHz @100Hz offset		-80		dBc/Hz
Phase Noise relative to carrier	30MHz @1kHz offset		-110		dBc/Hz
Phase Noise relative to carrier	30MHz @10kHz offset		-130		dBc/Hz
Phase Noise relative to carrier	30MHz @100kHz offset		-138		dBc/Hz
Phase Noise relative to carrier	30MHz @1MHz offset		-145		dBc/Hz

4. DC Specifications

PARAMETERS	SYMBOL	CONDITIONS	MIN.	TYP.	MAX.	UNITS
Supply Current, Dynamic, with Loaded Outputs (at VDD = 3.3V)	I _{DD}	At 10MHz, Cload=15pF		2.0	2.5	mA
		At 27MHz, Cload=15pF		4.0	4.5	
		At 48MHz, Cload=15pF		7.0	7.5	
Supply Current in Tri-State	I _{DD}	Output disabled			520	μA
Operating Voltage	V _{DD}		1.62		3.63	V
Output High Voltage	V _{OH}	I _{OH} = -12mA (3.3V)	2.4			V
Output Low Voltage	V _{OL}	I _{OL} = 12mA (3.3V)			0.4	V
Output High Voltage	V _{OHC}	I _{OH} = -4mA	V _{DD} - 0.4			V
Output Drive Current		At TTL level (3.3V)	12			mA

5. Crystal Specifications

PARAMETERS	SYMBOL	MIN.	TYP.	MAX.	UNITS
Crystal Resonator Frequency	F_{XIN}	10		52	MHz
Crystal Loading Rating	$C_{L(xtal)}$		8.5		pF
Maximum Sustainable Drive Level				200	μW
Operating Drive Level			50		μW
C0 (for frequencies below 30MHz)				5	pF
C0 (for frequencies above 30MHz)				4	pF
ESR	R_s			30	Ω

LAYOUT RECOMMENDATIONS

The following guidelines are to assist you with a performance optimized PCB design:

Signal Integrity and Termination Considerations

- Keep traces short!
- Trace = Inductor. With a capacitive load this equals ringing!
- Long trace = Transmission Line. Without proper termination this will cause reflections (looks like ringing).
- Design long traces (> 1 inch) as “striplines” or “microstrips” with defined impedance.
- Match trace at one side to avoid reflections bouncing back and forth.

Decoupling and Power Supply Considerations

- Place decoupling capacitors as close as possible to the VDD pin(s) to limit noise from the power supply
- Multiple VDD pins should be decoupled separately for best performance.
- Addition of a ferrite bead in series with VDD can help prevent noise from other board sources
- Value of decoupling capacitor is frequency dependant. Typical values to use are 0.1 μ F for designs using frequencies < 50MHz and 0.01 μ F for designs using frequencies > 50MHz.

Typical LVCMOS termination

Place Series Resistor as close as possible to LVCMOS output

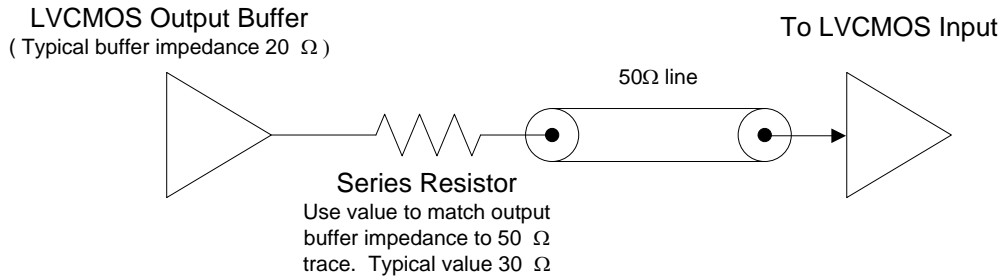

Crystal Tuning Circuit

Series and parallel capacitors used to fine tune the crystal load to the circuit load.

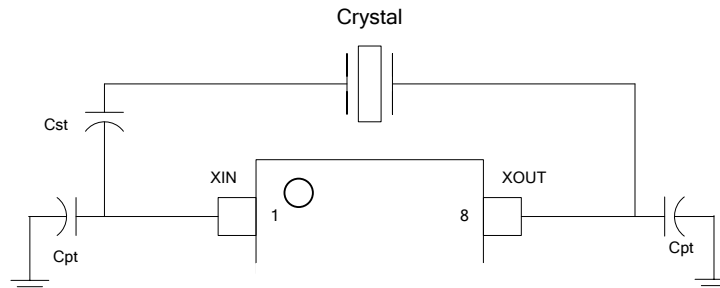

CST - Series Capacitor, used to lower circuit load to match crystal load. Raises frequency offset. This can be eliminated by using a crystal with a Cload of equal or greater value than the oscillator.

CPT - Parallel Capacitors, Used to raise the circuit load to match the crystal load. Lowers frequency offset.

PACKAGE DRAWINGS (GREEN PACKAGE COMPLIANT)

SOP-8L

Symbol	Dimension in MM	
	Min.	Max.
A	1.35	1.75
A1	0.10	0.25
A2	1.25	1.50
B	0.33	0.53
C	0.19	0.27
D	4.80	5.00
E	3.80	4.00
H	5.80	6.20
L	0.40	0.89
e	1.27 BSC	

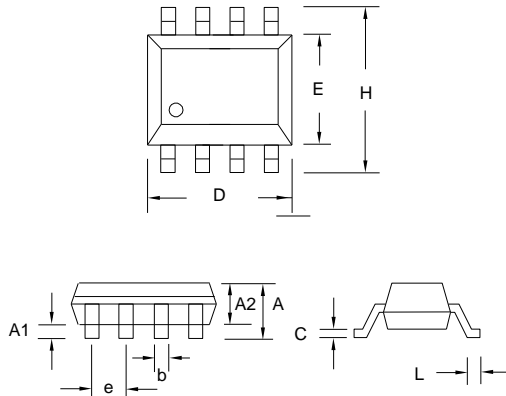

SOT23-6L

Symbol	Dimension in MM	
	Min.	Max.
A	1.05	1.35
A1	0.05	0.15
A2	1.00	1.20
b	0.30	0.50
c	0.08	0.20
D	2.80	3.00
E	1.50	1.70
H	2.60	3.00
L	0.35	0.55
e	0.95 BSC	

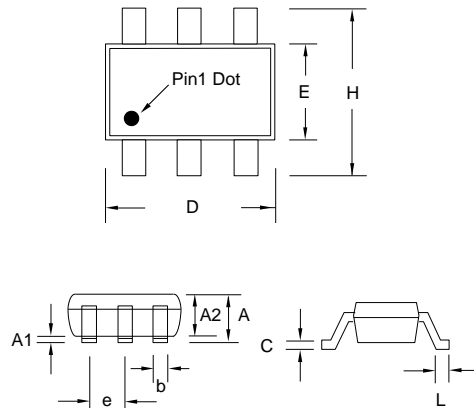

ORDERING INFORMATION (GREEN PACKAGE COMPLIANT)

For part ordering, please contact our Sales Department:
 2180 Fortune Drive, San Jose, CA 95131, USA
 Tel: (408) 944-0800 Fax: (408) 474-1000

PART NUMBER

The order number for this device is a combination of the following:
 Part number, Package type and Operating temperature range

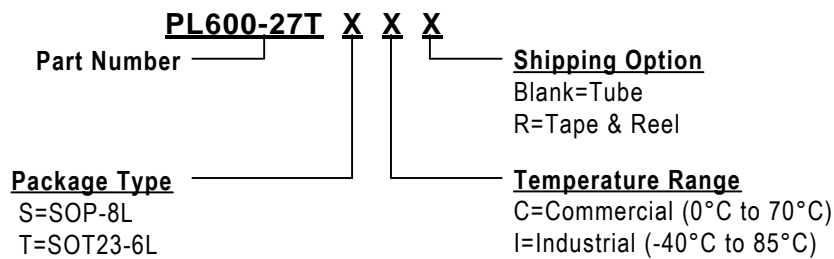

Part / Order Number	Marking	Package Option
PL600-27TSC	P600-27T SC	8-Pin SOP (Tube)
PL600-27TSC-R	LLLLL	8-Pin SOP (Tape and Reel)
PL600-27TSI	P600-27T SI	8-Pin SOP (Tube)
PL600-27TSI-R	LLLLL	8-Pin SOP (Tape and Reel)
PL600-27TTC-R	A27T LLL	6-Pin SOT23 (Tape and Reel)
PL600-27TTI-R	A27T LLLI	6-Pin SOT23 (Tape and Reel)

† **Marking Notes :**
 LLL and LLLLL represent the production lot number

Micrel Inc., reserves the right to make changes in its products or specifications, or both at any time without notice. The information furnished by Micrel is believed to be accurate and reliable. However, Micrel makes no guarantee or warranty concerning the accuracy of said information and shall not be responsible for any loss or damage of whatever nature resulting from the use of, or reliance upon this product.

LIFE SUPPORT POLICY: Micrel's products are not authorized for use as critical components in life support devices or systems without the express written approval of the President of Micrel Inc.