

## 阅读申明

- 1.本站收集的数据手册和产品资料都来自互联网，版权归原作者所有。如读者和版权方有任何异议请及时告之，我们将妥善解决。
- 2.本站提供的中文数据手册是英文数据手册的中文翻译，其目的是协助用户阅读，该译文无法自动跟随原稿更新，同时也可能存在翻译上的不当。建议读者以英文原稿为参考以便获得更精准的信息。
- 3.本站提供的产品资料，来自厂商的技术支持或者使用者的心得体会等，其内容可能存在描述上的差异，建议读者做出适当判断。
- 4.如需与我们联系，请发邮件到marketing@iczoom.com，主题请标有“数据手册”字样。

## Read Statement

1. The datasheets and other product information on the site are all from network reference or other public materials, and the copyright belongs to the original author and original published source. If readers and copyright owners have any objections, please contact us and we will deal with it in a timely manner.
2. The Chinese datasheets provided on the website is a Chinese translation of the English datasheets. Its purpose is for reader's learning exchange only and do not involve commercial purposes. The translation cannot be automatically updated with the original manuscript, and there may also be improper translations. Readers are advised to use the English manuscript as a reference for more accurate information.
3. All product information provided on the website refer to solutions from manufacturers' technical support or users the contents may have differences in description, and readers are advised to take the original article as the standard.
4. If you have any questions, please contact us at marketing@iczoom.com and mark the subject with "Datasheets" .

## HCSL Compatible Clock Generator for PCI Express

### FEATURES

- Input Frequency:
  - Fundamental Crystal or Reference Input: 25MHz
- Output Frequency:
  - PL602-21: 100MHz differential outputs.
  - PL602-22: 125MHz differential outputs.
  - PL602-23: 200MHz differential outputs.
  - PL602-26: 25MHz differential outputs.
  - PL602-27: 250MHz differential outputs.
  - PL602-15: 156.25 MHz differential outputs.
- Very low Jitter: 28ps Pk-Pk typ.
- Very low Phase Noise:
  - -130 dBc at 10kHz offset at 100MHz
- No external loop filter is required
- Power supply range: 2.25V to 3.63V
- Operating temperature range from -40°C to 85°C
- Available in 6-pin SOT or 8-pin SOP Green/RoHS compliant package.

### PIN CONFIGURATION

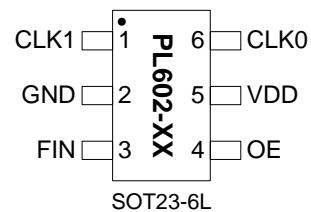
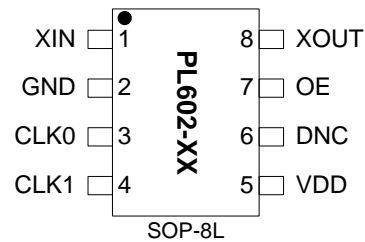

### DESCRIPTION

The PL602-XX is the smallest, high performance, lowest power differential output clock IC available for HCSL timing applications. PL602-XX offers -130dBc at 10kHz offset at 100MHz, with a very low jitter (2 ps TIE RMS), making it ideal for HCSL applications requiring small size and low power.

### BLOCK DIAGRAM

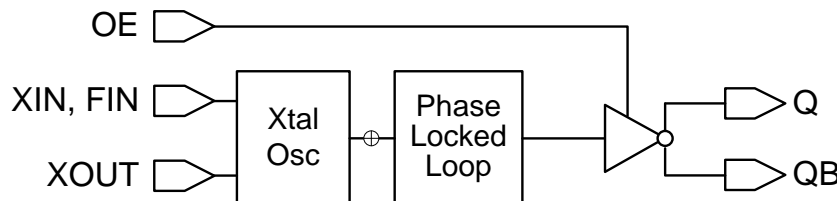

### PIN DESCRIPTION

Name	Pin #		Type	Description
	SOP	SOT23		
XIN	1	-	I	Crystal input (SOP package only)
FIN	-	3	I	Reference clock input (SOT23 package only)
GND	2	2	P	GND connection
CLK[0:1]	3,4	1,6	O	Differential clock outputs [note:CLK0=~CLK1]
VDD	5	5	P	VDD connection
DNC	6	-	-	Do not connect
OE	7	4	I	Output enable (OE) input. Internal 60KΩ pull up resistor.
XOUT	8	-	O	Crystal output pin.

**HCSL Compatible Clock Generator for PCI Express**
**ELECTRICAL SPECIFICATIONS**
**ABSOLUTE MAXIMUM RATINGS**

PARAMETERS	SYMBOL	MIN.	MAX.	UNITS
Supply Voltage Range	$V_{DD}$	-0.5	4.6	V
Input Voltage Range	$V_I$	-0.5	$V_{DD}+0.5$	V
Output Voltage Range	$V_O$	-0.5	$V_{DD}+0.5$	V
Soldering Temperature			260	°C
Storage Temperature	$T_S$	-65	150	°C
Ambient Operating Temperature*		-40	+85	°C

Exposure of the device under conditions beyond the limits specified by Maximum Ratings for extended periods may cause permanent damage to the device and affect product reliability. These conditions represent a stress rating only, and functional operations of the device at these or any other conditions above the operational limits noted in this specification is not implied. \*Operating temperature is guaranteed by design. Parts are tested to commercial grade only.

**AC SPECIFICATIONS**

PARAMETERS	CONDITIONS	MIN.	TYP.	MAX.	UNITS
Crystal Input Frequency	Fundamental Crystal		25		MHz
Input ( $F_{IN}$ ) Frequency			25		MHz
Input ( $F_{IN}$ ) Signal Amplitude	Internally AC coupled	0.9		$V_{DD}$	V <sub>pp</sub>
Output Frequency		25		200	MHz
Output Enable Time	OE Function; $T_a=25^\circ\text{C}$ , Add one clock period to this measurement for a usable clock output.			10	ns
Output Disable Time	OE Function; $T_a=25^\circ\text{C}$			10	ns
Settling Time	At power-up ( $V_{DD} \geq 2.25\text{V}$ )			10	ms
VDD Sensitivity	Frequency vs. $V_{DD}$ , $\pm 10\%$	-2		2	ppm
Output Rise Time	10/90% $V_{OH}$		0.3	0.5	ns
Output Fall Time	90/10% $V_{OH}$		0.3	0.5	ns
Skew Between Outputs	Measured at 50% $V_{OH}$			250	ps
Duty Cycle	At $V_{DD}/2$	45	50	55	%
Period Jitter, peak-to-peak	- With capacitive decoupling between $V_{DD}$ and GND - At 100MHz - 20,000 samples measured		28		ps
Cycle-to-Cycle, RMS			9		ps
Cycle-to-Cycle, peak			25		ps
TIE, RMS			2		ps

**HCSL Compatible Clock Generator for PCI Express**
**DC SPECIFICATIONS**

PARAMETERS	SYMBOL	CONDITIONS	MIN.	TYP.	MAX.	UNITS
Supply Current, Dynamic	$I_{DD}$	At 100MHz, No Load		25		mA
Operating Voltage	$V_{DD}$		2.25		3.63	V
Output Low Voltage	$V_{OL}$	HCSL termination, (RS = 150Ω, RT = 49.9Ω) 3.3V (RS = 100Ω, RT = 49.9Ω) 2.5V			0.05	V
Output High Voltage	$V_{OH}$		0.65	0.75	0.85	V
Output Current	$I_{OSD}$		13	15	17	mA

**CRYSTAL SPECIFICATIONS**

PARAMETERS	SYMBOL	MIN.	TYP.	MAX.	UNITS
Fundamental Crystal Resonator Frequency	$F_{XIN}$		25		MHz
Crystal Loading Rating	$C_L (xtal)$		18		pF
Maximum Sustainable Drive Level				500	μW
Operating Drive Level			100		μW
Crystal Shunt Capacitance	C0			6	pF
Effective Series Resistance, Fundamental	ESR			45	Ω

## HCSL Compatible Clock Generator for PCI Express

### PCI EXPRESS/HCSL COMPATIBLE LAYOUT GUIDELINES

Figure 1 below describes how to terminate the complementary LVCMOS outputs of PL602-XX for use with HCSL inputs.

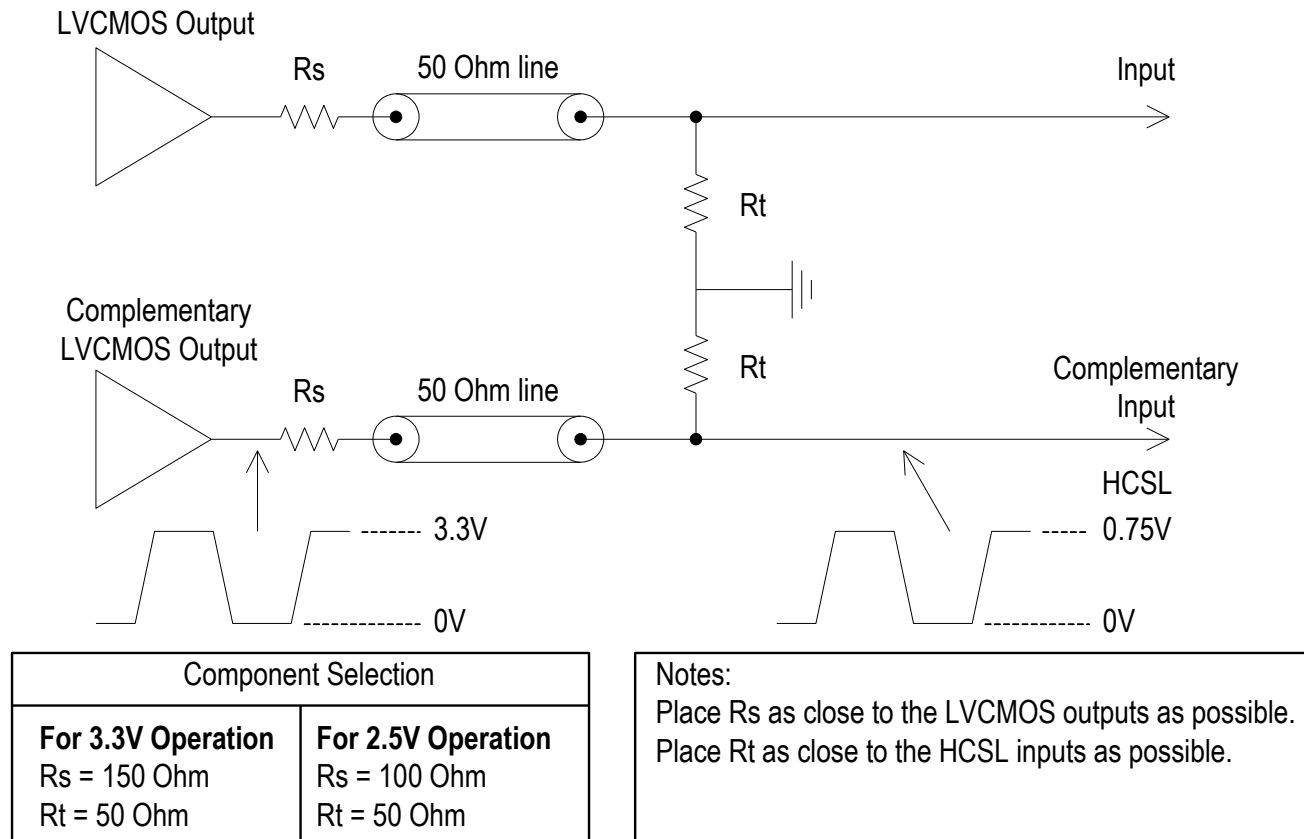

**Figure 1**

### PCB LAYOUT CONSIDERATIONS FOR PERFORMANCE OPTIMIZATION

The following guidelines are to assist you with a performance optimized PCB design:

- Keep all the PCB traces to PL602-XX as short as possible, as well as keeping all other traces as far away from it as possible.
- Place the crystal as close as possible to both crystal pins of the device. This will reduce the cross-talk between the crystal and the other signals.
- Separate crystal pin traces from the other signals on the PCB, but allow ample distance between the two crystal pin traces.
- Place a  $0.01\mu\text{F} \sim 0.1\mu\text{F}$  decoupling capacitor between VDD and GND, on the component side of the PCB, close to the VDD pin. It is not recommended to place this component on the backside of the PCB.
- It is highly recommended to keep the VDD and GND traces as short as possible.
- When connecting long traces ( $> 1$  inch) to a CMOS output, it is important to design the traces as a transmission line or 'stripline', to avoid reflections or ringing. In this case, the CMOS output needs to be matched to the trace impedance. Usually 'striplines' are designed for  $50\Omega$  impedance and CMOS outputs usually have lower than  $50\Omega$  impedance so matching can be achieved by adding a resistor in series with the CMOS output pin to the 'stripline' trace.

## HCSL Compatible Clock Generator for PCI Express

### PACKAGE DRAWINGS (GREEN PACKAGE COMPLIANT)

#### SOP-8L

Symbol	Dimension in MM	
	Min.	Max.
A	1.35	1.75
A1	0.10	0.25
A2	1.25	1.50
B	0.33	0.53
C	0.19	0.27
D	4.80	5.00
E	3.80	4.00
H	5.80	6.20
L	0.40	0.89
e	1.27 BSC	

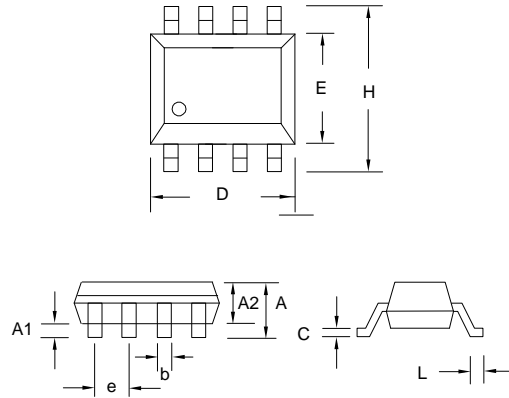

#### SOT23-6L

Symbol	Dimension in MM	
	Min.	Max.
A	1.05	1.35
A1	0.05	0.15
A2	1.00	1.20
B	0.30	0.50
C	0.08	0.20
D	2.80	3.00
E	1.50	1.70
H	2.60	3.0
L	0.35	0.55
e	0.95 BSC	

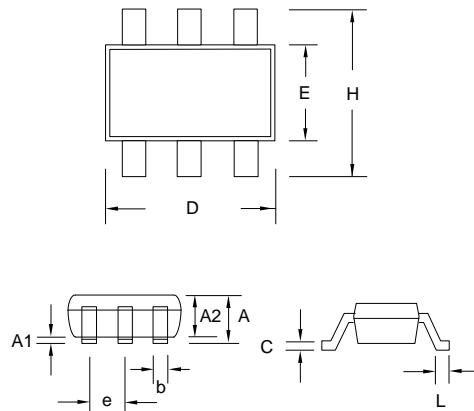

## HCSL Compatible Clock Generator for PCI Express

### ORDERING INFORMATION (GREEN PACKAGE COMPLIANT)

**For part ordering, please contact our Sales Department:**

2180 Fortune Drive, San Jose, CA 95131, USA

Tel: (408) 944-0800 Fax: (408) 474-1000

#### PART NUMBER

The order number for this device is a combination of the following:

Part number, Package type and Operating temperature range

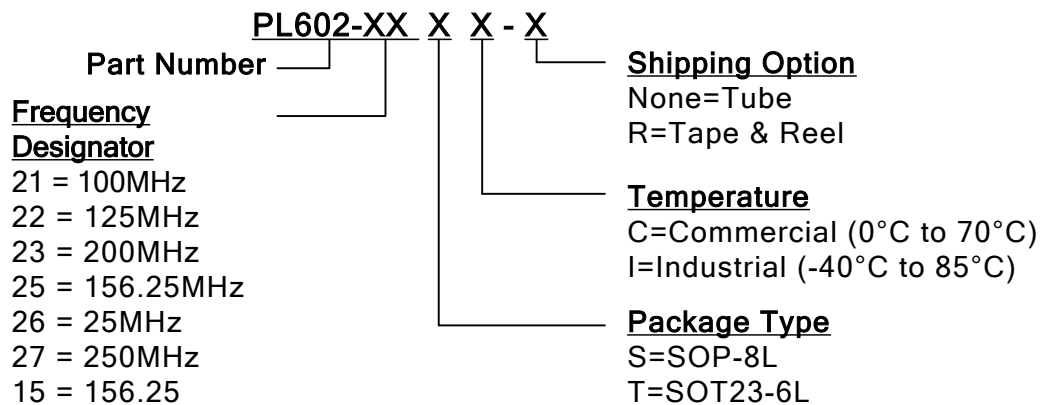

Part / Order Number	Marking	Package Option
PL602-2XSC	P602-2X SC	8-Pin SOP (Tube)
PL602-2XSC-R	LLLLL	8-Pin SOP (Tape and Reel)
PL602-1XTC-R	F1X LLL	6-Pin SOT-23 (Tape and Reel)
PL602-2XTC-R	F2X LLL	6-Pin SOT-23 (Tape and Reel)

Note: LLL / LLLLL designate Production Lot.

Micrel Inc., reserves the right to make changes in its products or specifications, or both at any time without notice. The information furnished by Micrel is believed to be accurate and reliable. However, Micrel makes no guarantee or warranty concerning the accuracy of said information and shall not be responsible for any loss or damage of whatever nature resulting from the use of, or reliance upon this product.

**LIFE SUPPORT POLICY:** Micrel's products are not authorized for use as critical components in life support devices or systems without the express written approval of the President of Micrel Inc.