

阅读申明

- 1.本站收集的数据手册和产品资料都来自互联网，版权归原作者所有。如读者和版权方有任何异议请及时告之，我们将妥善解决。
- 2.本站提供的中文数据手册是英文数据手册的中文翻译，其目的是协助用户阅读，该译文无法自动跟随原稿更新，同时也可能存在翻译上的不当。建议读者以英文原稿为参考以便获得更精准的信息。
- 3.本站提供的产品资料，来自厂商的技术支持或者使用者的心得体会等，其内容可能存在描述上的差异，建议读者做出适当判断。
- 4.如需与我们联系，请发邮件到marketing@iczoom.com，主题请标有“数据手册”字样。

Read Statement

1. The datasheets and other product information on the site are all from network reference or other public materials, and the copyright belongs to the original author and original published source. If readers and copyright owners have any objections, please contact us and we will deal with it in a timely manner.
2. The Chinese datasheets provided on the website is a Chinese translation of the English datasheets. Its purpose is for reader's learning exchange only and do not involve commercial purposes. The translation cannot be automatically updated with the original manuscript, and there may also be improper translations. Readers are advised to use the English manuscript as a reference for more accurate information.
3. All product information provided on the website refer to solutions from manufacturers' technical support or users the contents may have differences in description, and readers are advised to take the original article as the standard.
4. If you have any questions, please contact us at marketing@iczoom.com and mark the subject with "Datasheets" .



Factory-Programmable, Single PLL Clock Generator

MAX9491

General Description

The MAX9491 multipurpose clock generator is ideal for communication applications. It offers a factory-programmable PLL output that can be set to almost any frequency, ranging from 4MHz to 200MHz. The MAX9491 uses a one-time-programmable (OTP) ROM to program the PLL output. The MAX9491 also features an integrated voltage-controlled crystal oscillator (VCXO) that is tuned by a DC voltage. The VCXO output is used as the PLL input. The VCXO has a wide ± 200 ppm (typ) tuning range. The OTP on the MAX9491 is factory preset, based upon the customer request. Contact the factory for samples with preferred frequencies.

The device operates from a 3.3V supply and is specified over the -40°C to $+85^{\circ}\text{C}$ extended temperature range. The MAX9491 is available in 14-pin TSSOP and 20-pin TQFN (5mm x 5mm) packages.

Applications

Telecommunications
Data Networking Systems
Home Entertainment Centers
SOHO

Features

- ◆ 5MHz to 35MHz for Crystal-Clock Reference
- ◆ 5MHz to 50MHz for a Driver Clock Reference
- ◆ One Fractional-N PLL with Buffered Output
- ◆ 4MHz to 200MHz Output Frequency Range
- ◆ Low RMS Jitter PLL (< 13 ps) at 197 MHz
- ◆ Integrated VCXO with ± 200 ppm Tuning Range
- ◆ Available in 14-Pin TSSOP and 20-Pin TQFN Packages
- ◆ +3.3V Supply
- ◆ -40°C to $+85^{\circ}\text{C}$ Temperature Range

Ordering Information

PART	TEMP RANGE	PIN-PACKAGE	PKG CODE
MAX9491ETP	-40°C to $+85^{\circ}\text{C}$	20 TQFN-EP**	T2055-5
MAX9491EUD*	-40°C to $+85^{\circ}\text{C}$	14 TSSOP	U14-2

*Future product—contact factory for availability.

**EP = Exposed pad.

Pin Configurations

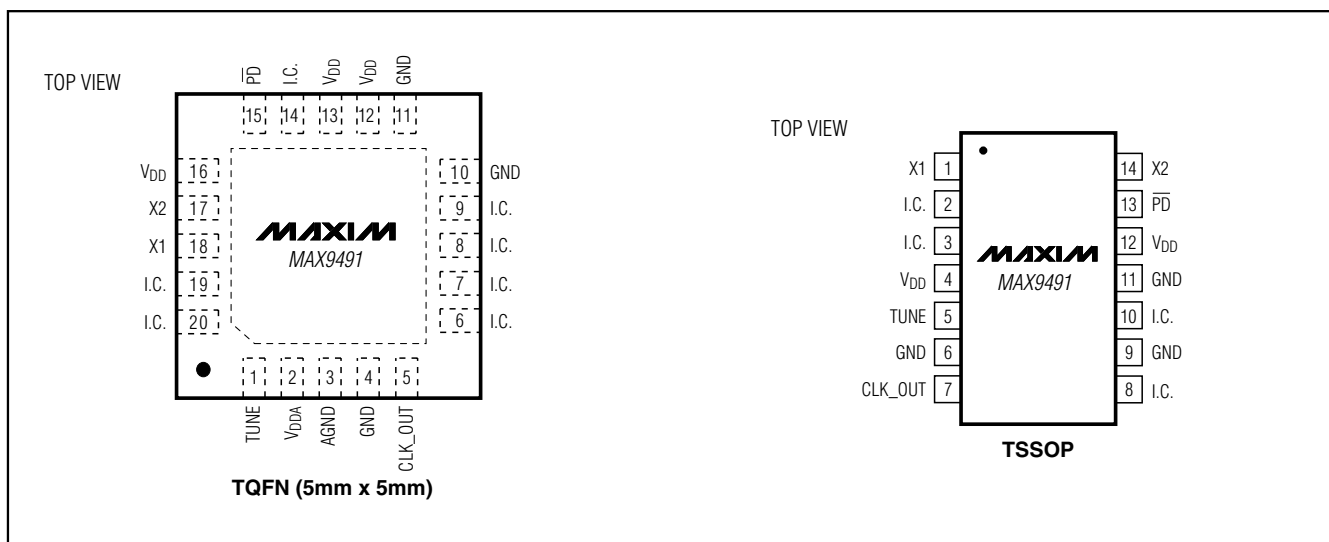

Factory Programmable Single PLL Clock Generator

ABSOLUTE MAXIMUM RATINGS

V_{DD} to GND-0.3V to +4.0V
 V_{DDA} to AGND-0.3V to +4.0V
 All Other Pins to GND-0.3V to V_{DD} + 0.3V
 Short-Circuit Duration
 (all LVC MOS outputs).....Continuous
 ESD Protection (Human Body Model).....±2kV

Continuous Power Dissipation (T_A = +70°C)
 20-Lead TQFN (derate 21.3mW/°C above +70°C)2758mW
 14-Pin TSSOP (derate 9.1mW/°C above +70°C)796.8mW
 Storage Temperature Range-65°C to +150°C
 Maximum Junction Temperature+150°C
 Operating Temperature Range-40°C to +85°C
 Lead Temperature (soldering, 10s)+300°C

Stresses beyond those listed under "Absolute Maximum Ratings" may cause permanent damage to the device. These are stress ratings only, and functional operation of the device at these or any other conditions beyond those indicated in the operational sections of the specifications is not implied. Exposure to absolute maximum rating conditions for extended periods may affect device reliability.

DC ELECTRICAL CHARACTERISTICS

(V_{DD} = V_{DDA} = +3.0V to +3.6V and T_A = -40°C to +85°C. Typical values at V_{DD} = V_{DDA} = 3.3V, T_A = +25°C, unless otherwise noted.)
 (Note 1)

PARAMETER	SYMBOL	CONDITIONS	MIN	TYP	MAX	UNITS
LVC MOS INPUTS (\overline{PD}, X1 as a reference INPUT CLK)						
Input High Level	V _{IH}		2.0		V _{DD}	V
Input Low Level	V _{IL}		0		0.8	V
High-Level Input Current	I _{IH}	V _{IN} = V _{DD}			20	μA
Low-Level Input Current	I _{IL}	V _{IN} = 0	-20			μA
CLOCK OUTPUT (CLK_OUT)						
Output High Level	V _{OH}	I _{OH} = -4mA	V _{DD} - 0.6			V
Output Low Level	V _{OL}	I _{OL} = 4mA			0.4	V
POWER SUPPLIES						
Digital Power-Supply Voltage	V _{DD}		3.0		3.6	V
Analog Power-Supply Voltage	V _{DDA}		3.0		3.6	V
Total Current for Digital and Analog Supplies	I _{DC}	f _{OUT} = 45MHz, no load f _{IN} = 13MHz		10		mA
Power-Down Current	I _{DC2}	\overline{PD} = low		60		μA

Factory Programmable Single PLL Clock Generator

MAX9491

AC ELECTRICAL CHARACTERISTICS

($V_{DD} = V_{DDA} = +3.0V$ to $+3.6V$, $C_L = 10pF$ and $T_A = -40^{\circ}C$ to $+85^{\circ}C$. Typical values are at $V_{DD} = V_{DDA} = 3.3V$, $T_A = +25^{\circ}C$, unless otherwise noted.) (Note 2)

PARAMETER	SYMBOL	CONDITIONS	MIN	TYP	MAX	UNITS
OUTPUT CLOCK (CLK_OUT)						
Minimum Frequency Range	f_{OUT}	$f_{IN} = 5MHz$ to $50MHz$	4			MHz
Maximum Frequency Range		$C_L < 5pF$	133	200		
Clock Rise Time	t_R	20% to 80% of V_{DD} , $f_{OUT} = 80MHz$, $f_{IN} = 13MHz$	1.5			ns
Clock Fall Time	t_F	80% to 20% of V_{DD} , $f_{OUT} = 80MHz$, $f_{IN} = 13MHz$	1.3			ns
Duty Cycle		$f_{OUT} = 45MHz$, $f_{IN} = 13MHz$	44	50	56	%
Output Period Jitter	J_P	$f_{OUT} = 45MHz$, $f_{IN} = 13MHz$	14			ps RMS
		$f_{OUT} = 80MHz$, $f_{IN} = 13MHz$	22			
		$f_{OUT} = 197MHz$, $f_{IN} = 13MHz$	13			
Soft Power-On Time	t_{PO2}	\overline{PD} from low to high, $f_{OUT} = 45MHz$, $f_{IN} = 13MHz$, see Figure 2	1			ms
Hard Power-On Time	t_{PO1}	See Figure 2	15			ms
VCXO CLOCK						
Crystal Frequency	f_{XTL}		27			MHz
Crystal Accuracy			± 30			ppm
Tuning Voltage Range	V_{TUNE}		0	3		V
VCXO Tuning Range		$V_{TUNE} = 0$ to $3V$, $C_1 = C_2 = 4pF$	± 150	± 200		ppm
TUNE Input Impedance	Z_{TUNE}		95			$k\Omega$
Output CLK Accuracy		$V_{TUNE} = 1.5V$, $C_1 = C_2 = 4pF$	± 50			ppm

Note 1: All parameters are tested at $T_A = +25^{\circ}C$. Specifications over temperature are guaranteed by design and characterization.

Note 2: Guaranteed by design and characterization; limits are set at ± 6 sigma.

Factory Programmable Single PLL Clock Generator

Typical Operating Characteristics

(VDD = VDDA = +3.3V, TA = +25°C, fIN = 13MHz clock, CL = 10pF, 27MHz, unless otherwise noted.)

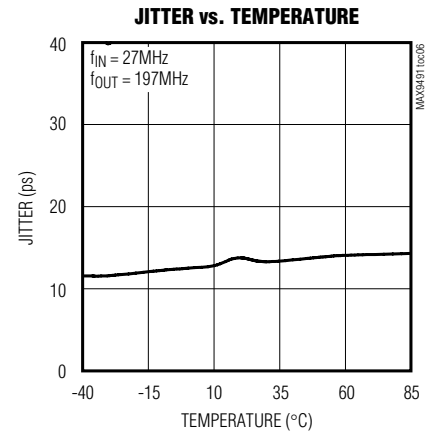
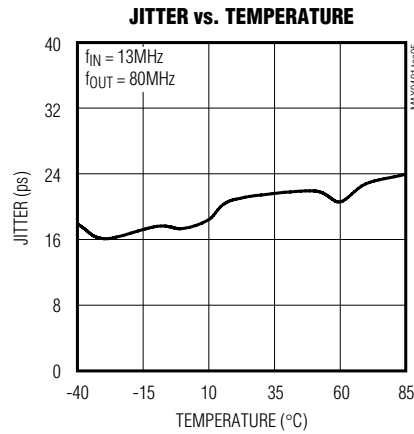
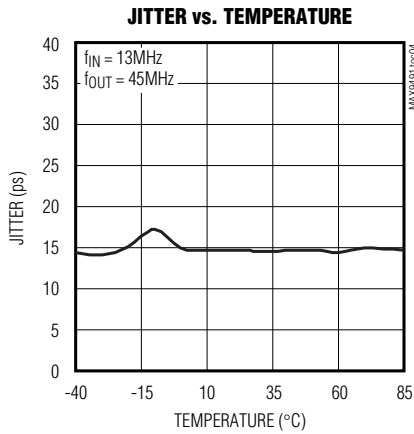
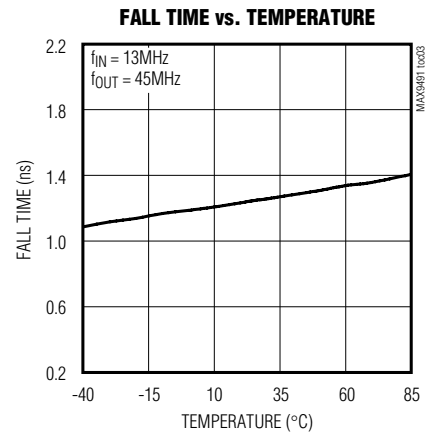
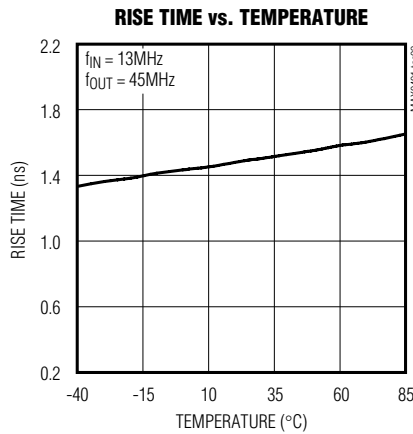
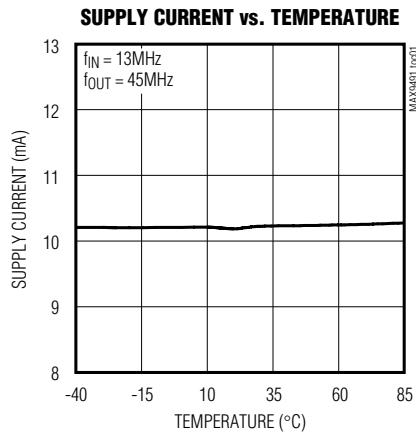

TYPICAL CLK_OUT WAVEFORM AT 45MHz

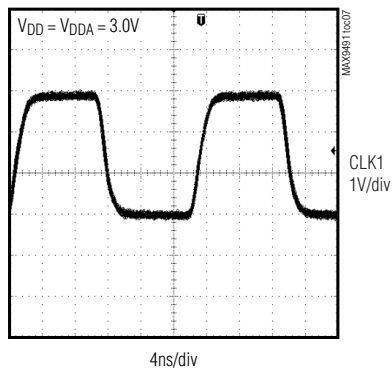

TYPICAL CLK_OUT WAVEFORM AT 80MHz

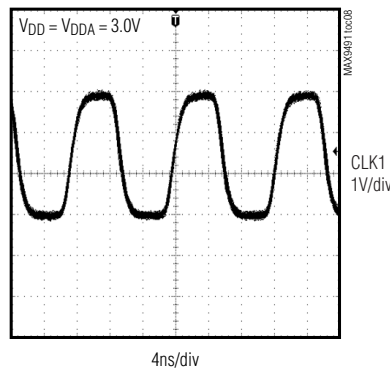

TYPICAL CLK_OUT WAVEFORM AT 197MHz

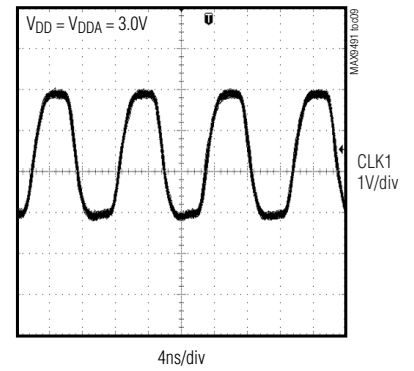

Factory Programmable Single PLL Clock Generator

Typical Operating Characteristics (continued)

(VDD = VDDA = +3.3V, TA = +25°C, f_{IN} = 13MHz clock, C_L = 10pF, 27MHz, unless otherwise noted.)

MAX9491

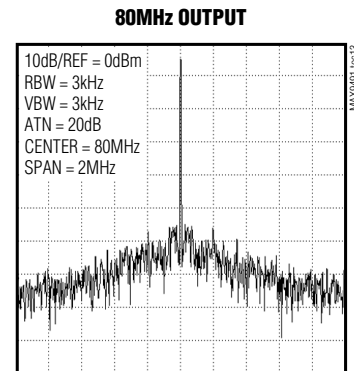
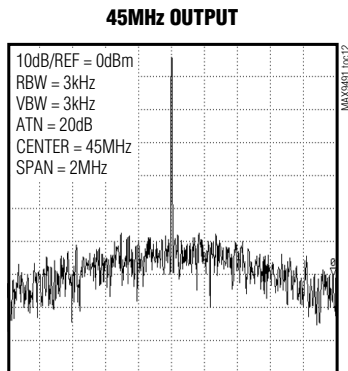
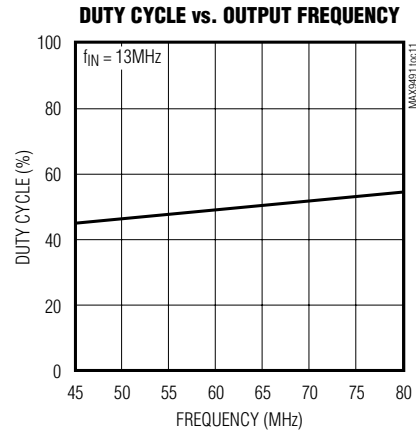
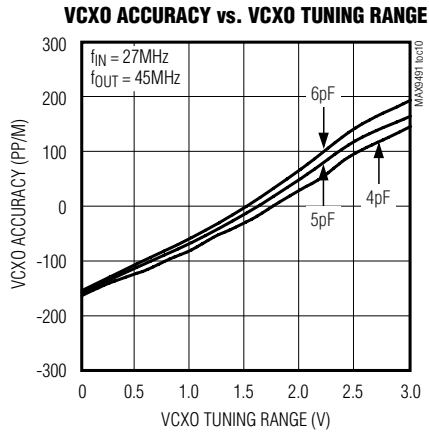

Factory Programmable Single PLL Clock Generator

Typical Operating Circuit/Block Diagram

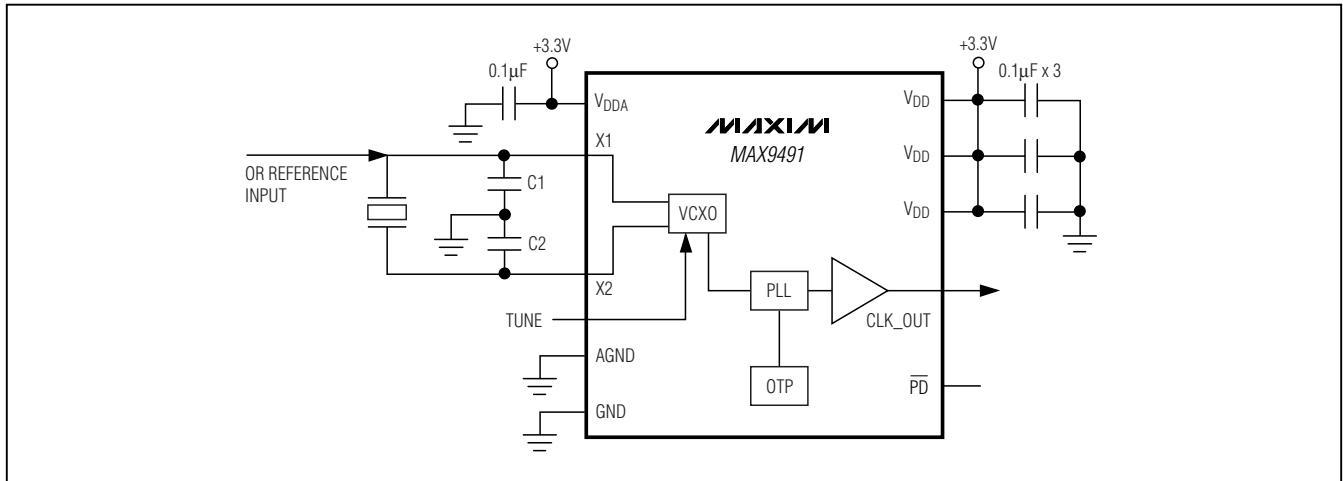

Pin Description

PIN		NAME	FUNCTION
TQFN	TSSOP		
1	5	TUNE	VCXO Tune Voltage Input. If using a reference clock input or VCXO is not used, connect TUNE to V _{DD} .
2	—	V _{DDA}	Analog Power Supply. Bypass to GND with a 0.1µF capacitor.
3	—	AGND	Analog Ground
4, 10, 11	6, 9, 11	GND	Ground
5	7	CLK_OUT	Output Clock. Internally pulled down.
6–9, 14, 19, 20	2, 3, 8, 10	I.C.	Internally Connected. Leave unconnected for normal operation.
12, 13, 16	4, 12	V _{DD}	Power Supply. Bypass to GND with a 0.1µF capacitor.
15	13	$\overline{\text{PD}}$	Active-Low Power-Down Input. Pull high for normal operation. Drive $\overline{\text{PD}}$ low to place MAX9491 in power-down mode. Internally pulled down.
17	14	X2	Crystal Connection 2. Leave unconnected if using a reference clock.
18	1	X1	Crystal Connection 1 or Reference Clock Input
EP	—	EP	Exposed Paddle (TQFN Only). Connect EP to GND or leave unconnected.

Detailed Description

The MAX9491 features a programmable fractional-N PLL, so frequencies between 4MHz to 200MHz can be generated. The device provides a buffered PLL clock output. The crystal input frequency can be between 5MHz and 35MHz, and the clock input between 5MHz and 50MHz. The internal VCXO has a fine-tuning range of ± 200 ppm.

Power-Down

Driving $\overline{\text{PD}}$ low places the MAX9491 in power-down mode. $\overline{\text{PD}}$ then sets CLK_OUT to high impedance and

shuts down the PLL. CLK_OUT has an 80k Ω (typ) internal pulldown resistor.

Voltage-Controlled Crystal Oscillator (VCXO)

The MAX9491's internal VCXO produces a reference clock for the PLL used to generate the CLK_OUT. The oscillator uses a crystal as the base frequency reference and has a voltage-controlled tuning input for micro adjustment in a ± 200 ppm range. The tuning voltage, V_{TUNE}, can vary from 0 to 3V as shown in Figure 1. The crystal should be AT-cut and oscillate on its fundamental mode with ± 30 ppm. The crystal shunt capacitor

Factory Programmable Single PLL Clock Generator

should be less than 10pF, including board parasitic capacitance. To achieve up to ± 200 ppm pullability, make sure the crystal-loading capacitance is less than 14pF. The VCXO is a free-running oscillator. It starts oscillating

with an internal POR signal and can be disabled by $\overline{\text{PD}}$. When VCXO is not used, connect TUNE to V_{DD} .

Applications Information

Using an Input Clock as the Reference

When an input clock is used as the reference, connect the input clock to X1, leave X2 unconnected, and connect TUNE to V_{DD} .

Crystal Selection

When using a crystal with the MAX9491's internal oscillator, connect the crystal to X1 and X2. Choose an AT-cut crystal that oscillates on its fundamental mode with ± 30 ppm and loading capacitance less than 14pF. To achieve a wide VCXO tuning range, select a crystal with motional capacitance greater than 7fF and connect 6pF or less shunt capacitors at both X1 and X2 to ground. When the VCXO is used as an oscillator, select both shunt capacitors to approximately 13pF. The optimal shunt capacitors for achieving minimum frequency offset can be determined experimentally.

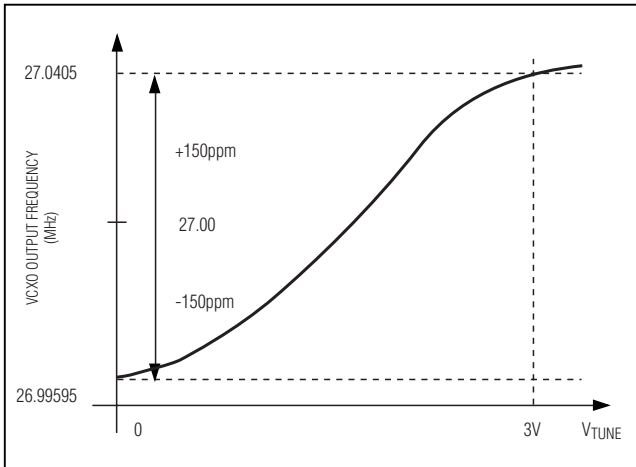

Figure 1. VCXO Tuning Range for a 27MHz Crystal

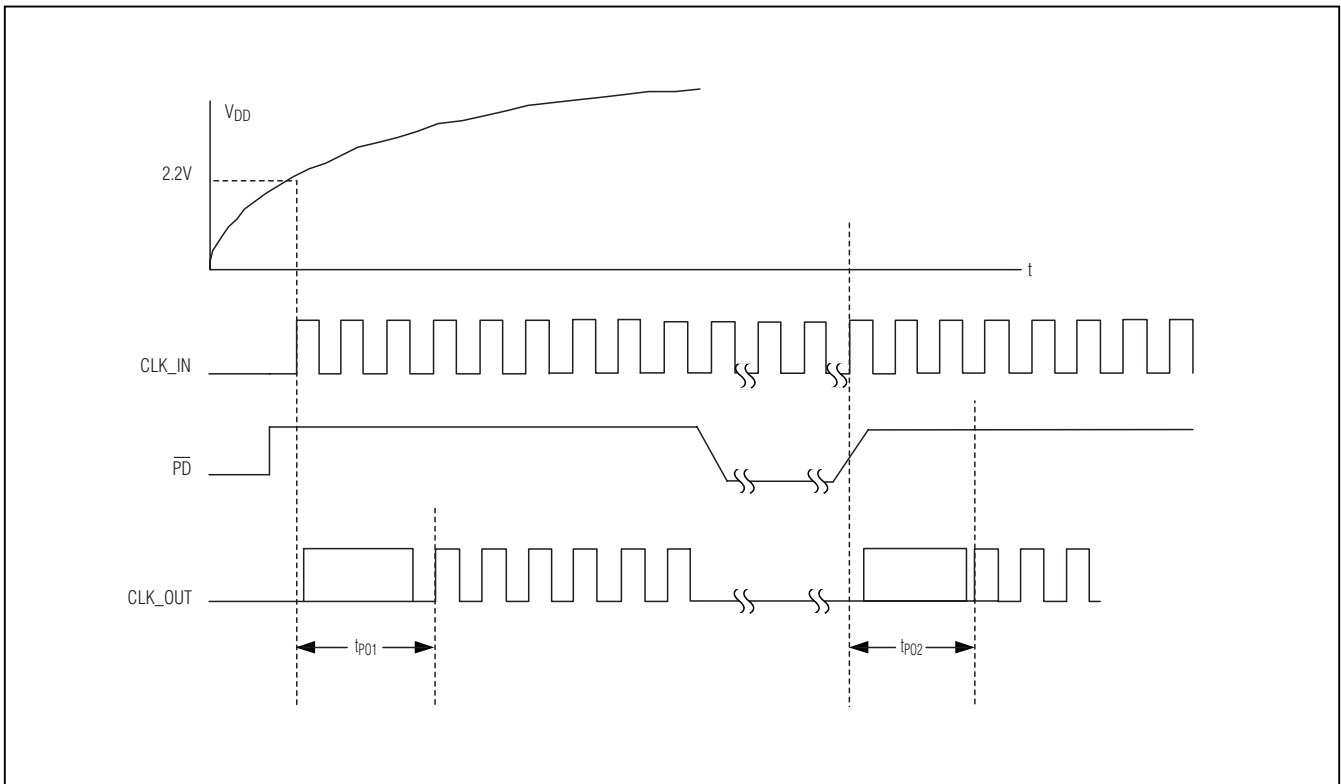

Figure 2. PLL Settling Time

Factory Programmable Single PLL Clock Generator

Board Layout Considerations and Bypassing

The MAX9491's high-frequency oscillator requires proper layout to ensure stability. For best performance, place components as close as possible to the device.

Digital or AC transient signals on GND can create noise at the clock output. Return GND to the highest quality ground available. Bypass each V_{DD} and V_{DDA} with a $0.1\mu\text{F}$ capacitor, placed as close as possible to the device. Careful PC board ground layout minimizes crosstalk between the output and digital inputs.

Chip Information

PROCESS: CMOS

Factory Programmable Single PLL Clock Generator

Package Information

(The package drawing(s) in this data sheet may not reflect the most current specifications. For the latest package outline information, go to www.maxim-ic.com/packages.)

MAX9491

TSSOP4, 4.0mm, EPS

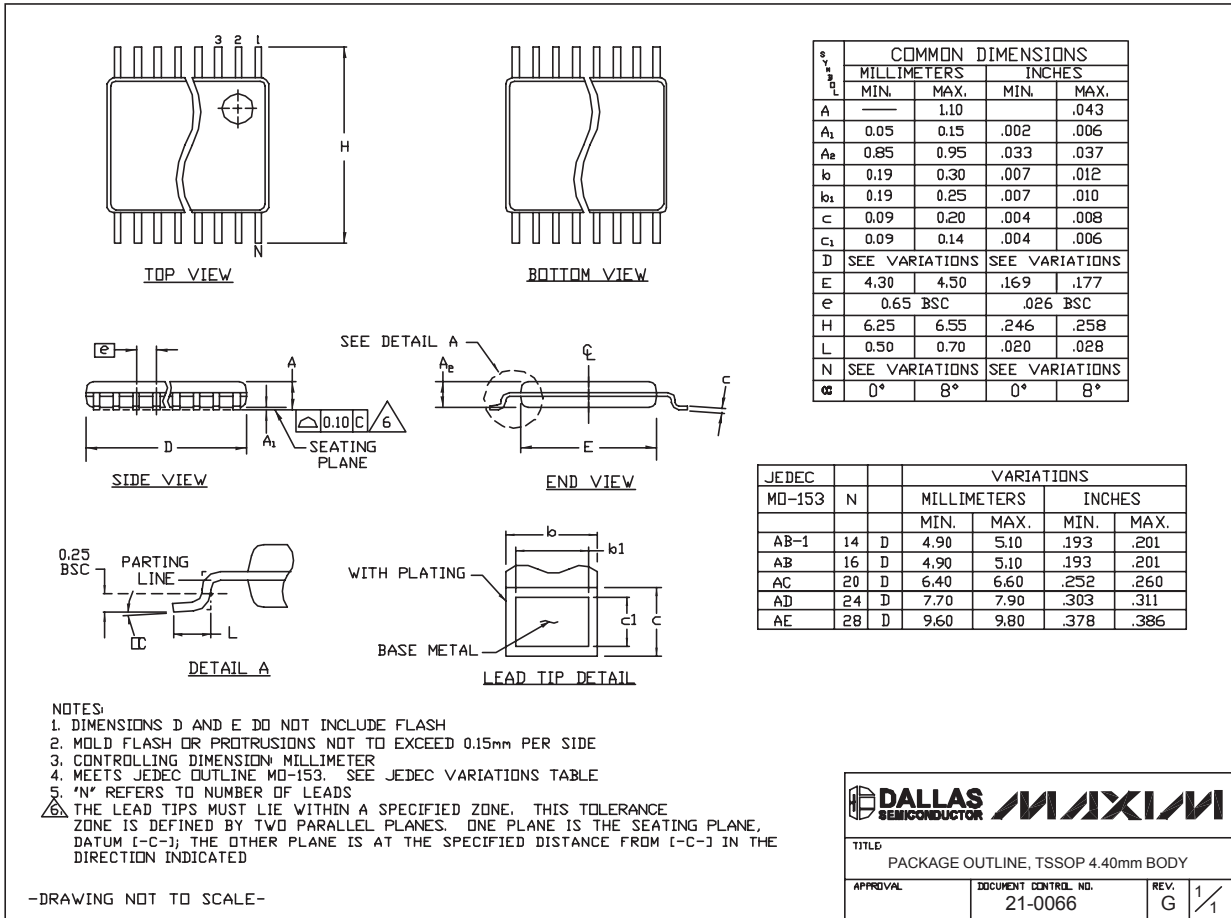

Factory Programmable Single PLL Clock Generator

Package Information (continued)

(The package drawing(s) in this data sheet may not reflect the most current specifications. For the latest package outline information, go to www.maxim-ic.com/packages.)

MAX9491

COMMON DIMENSIONS															
PKG. SYMBOL	16L 5x5			20L 5x5			28L 5x5			32L 5x5			40L 5x5		
	MIN.	NOM.	MAX.	MIN.	NOM.	MAX.	MIN.	NOM.	MAX.	MIN.	NOM.	MAX.	MIN.	NOM.	MAX.
A	0.70	0.75	0.80	0.70	0.75	0.80	0.70	0.75	0.80	0.70	0.75	0.80	0.70	0.75	0.80
A1	0	0.02	0.05	0	0.02	0.05	0	0.02	0.05	0	0.02	0.05	0	0.02	0.05
A3	0.20 REF.			0.20 REF.			0.20 REF.			0.20 REF.			0.20 REF.		
b	0.25	0.30	0.35	0.25	0.30	0.35	0.20	0.25	0.30	0.20	0.25	0.30	0.15	0.20	0.25
D	4.90	5.00	5.10	4.90	5.00	5.10	4.90	5.00	5.10	4.90	5.00	5.10	4.90	5.00	5.10
E	4.90	5.00	5.10	4.90	5.00	5.10	4.90	5.00	5.10	4.90	5.00	5.10	4.90	5.00	5.10
e	0.80 BSC.			0.65 BSC.			0.50 BSC.			0.50 BSC.			0.40 BSC.		
k	0.25	-	-	0.25	-	-	0.25	-	-	0.25	-	-	0.25	0.35	0.45
L	0.30	0.40	0.50	0.45	0.55	0.65	0.45	0.55	0.65	0.30	0.40	0.50	0.40	0.50	0.60
L1	-	-	-	-	-	-	-	-	-	-	-	-	0.30	0.40	0.50
N	16			20			28			32			40		
ND	4			5			7			8			10		
NE	4			5			7			8			10		
JEDEC	WHHB			WHHC			WHHD-1			WHHD-2			----		

EXPOSED PAD VARIATIONS									
PKG. CODES	D2			E2			L EXPOSED ±0.15	DOWN BONDS ALLOWED	
	MIN.	NOM.	MAX.	MIN.	NOM.	MAX.			
T1655-2	3.00	3.10	3.20	3.00	3.10	3.20	**	YES	
T1655-3	3.00	3.10	3.20	3.00	3.10	3.20	**	NO	
T1655N-1	3.00	3.10	3.20	3.00	3.10	3.20	**	NO	
T2055-3	3.00	3.10	3.20	3.00	3.10	3.20	**	YES	
T2055-4	3.00	3.10	3.20	3.00	3.10	3.20	**	NO	
T2055-5	3.15	3.25	3.35	3.15	3.25	3.35	0.40	YES	
T2855-3	3.15	3.25	3.35	3.15	3.25	3.35	**	YES	
T2855-4	2.60	2.70	2.80	2.60	2.70	2.80	**	YES	
T2855-5	2.60	2.70	2.80	2.60	2.70	2.80	**	NO	
T2855-6	3.15	3.25	3.35	3.15	3.25	3.35	**	NO	
T2855-7	2.60	2.70	2.80	2.60	2.70	2.80	**	YES	
T2855-8	3.15	3.25	3.35	3.15	3.25	3.35	0.40	YES	
T2855N-1	3.15	3.25	3.35	3.15	3.25	3.35	**	NO	
T3255-3	3.00	3.10	3.20	3.00	3.10	3.20	**	YES	
T3255-4	3.00	3.10	3.20	3.00	3.10	3.20	**	NO	
T3255-5	3.00	3.10	3.20	3.00	3.10	3.20	**	YES	
T3255N-1	3.00	3.10	3.20	3.00	3.10	3.20	**	NO	
T4055-1	3.20	3.30	3.40	3.20	3.30	3.40	**	YES	

**SEE COMMON DIMENSIONS TABLE

NOTES:

- DIMENSIONING & TOLERANCING CONFORM TO ASME Y14.5M-1994.
- ALL DIMENSIONS ARE IN MILLIMETERS. ANGLES ARE IN DEGREES.
- N IS THE TOTAL NUMBER OF TERMINALS.
- THE TERMINAL #1 IDENTIFIER AND TERMINAL NUMBERING CONVENTION SHALL CONFORM TO JEDEC 95-1 SPP-012. DETAILS OF TERMINAL #1 IDENTIFIER ARE OPTIONAL, BUT MUST BE LOCATED WITHIN THE ZONE INDICATED. THE TERMINAL #1 IDENTIFIER MAY BE EITHER A MOLD OR MARKED FEATURE.
- DIMENSION b APPLIES TO METALLIZED TERMINAL AND IS MEASURED BETWEEN 0.25 mm AND 0.30 mm FROM TERMINAL TIP.
- ND AND NE REFER TO THE NUMBER OF TERMINALS ON EACH D AND E SIDE RESPECTIVELY.
- DEPOPULATION IS POSSIBLE IN A SYMMETRICAL FASHION.
- COPLANARITY APPLIES TO THE EXPOSED HEAT SINK SLUG AS WELL AS THE TERMINALS.
- DRAWING CONFORMS TO JEDEC MO220, EXCEPT EXPOSED PAD DIMENSION FOR T2855-3 AND T2855-6.
- WARPAGE SHALL NOT EXCEED 0.10 mm.
- MARKING IS FOR PACKAGE ORIENTATION REFERENCE ONLY.
- NUMBER OF LEADS SHOWN ARE FOR REFERENCE ONLY.
- LEAD CENTERLINES TO BE AT TRUE POSITION AS DEFINED BY BASIC DIMENSION "e", ±0.05.

-DRAWING NOT TO SCALE-

TITLE PACKAGE OUTLINE, 16, 20, 28, 32, 40L THIN QFN, 5x5x0.8mm	
APPROVAL	DOCUMENT CONTROL NO. 21-0140
REV. 1	2/2

Maxim cannot assume responsibility for use of any circuitry other than circuitry entirely embodied in a Maxim product. No circuit patent licenses are implied. Maxim reserves the right to change the circuitry and specifications without notice at any time.

Maxim Integrated Products, 120 San Gabriel Drive, Sunnyvale, CA 94086 408-737-7600 11