

阅读申明

- 1.本站收集的数据手册和产品资料都来自互联网，版权归原作者所有。如读者和版权方有任何异议请及时告之，我们将妥善解决。
- 2.本站提供的中文数据手册是英文数据手册的中文翻译，其目的是协助用户阅读，该译文无法自动跟随原稿更新，同时也可能存在翻译上的不当。建议读者以英文原稿为参考以便获得更精准的信息。
- 3.本站提供的产品资料，来自厂商的技术支持或者使用者的心得体会等，其内容可能存在描述上的差异，建议读者做出适当判断。
- 4.如需与我们联系，请发邮件到marketing@iczoom.com，主题请标有“数据手册”字样。

Read Statement

1. The datasheets and other product information on the site are all from network reference or other public materials, and the copyright belongs to the original author and original published source. If readers and copyright owners have any objections, please contact us and we will deal with it in a timely manner.
2. The Chinese datasheets provided on the website is a Chinese translation of the English datasheets. Its purpose is for reader's learning exchange only and do not involve commercial purposes. The translation cannot be automatically updated with the original manuscript, and there may also be improper translations. Readers are advised to use the English manuscript as a reference for more accurate information.
3. All product information provided on the website refer to solutions from manufacturers' technical support or users the contents may have differences in description, and readers are advised to take the original article as the standard.
4. If you have any questions, please contact us at marketing@iczoom.com and mark the subject with "Datasheets" .

Two-PLL Programmable Clock Generator with Spread Spectrum

Features

- Two fully integrated phase-locked loops (PLLs)
- Input frequency range
 - External crystal: 8 to 48 MHz
 - External reference: 8 to 166 MHz clock
- Reference clock input voltage range
 - 2.5 V, 3.0 V, and 3.3 V for CY25482
 - 1.8 V for CY25402 and CY25422
- Wide operating output frequency range
 - 3 to 166 MHz
- Programmable^[1] spread spectrum with center and down spread option and lexmark and linear modulation profiles
- V_{DD} supply voltage options:
 - 2.5 V, 3.0 V, and 3.3 V for CY25402 and CY25482
 - 1.8 V for CY25422
- Frequency select feature with option to select four different frequencies
- Power-down, Output Enable, and SS ON/OFF controls
- Low jitter, high-accuracy outputs
- Ability to synthesize nonstandard frequencies with fractional-N capability
- Three clock outputs with programmable drive strength
- Glitch-free outputs while frequency switching

- 8-pin small outline integrated circuit (SOIC) package
- Commercial and industrial temperature ranges
- One-time programmability
For programming support, contact [Cypress technical support](#) or send an email to clocks@cypress.com

Benefits

- Multiple high-performance PLLs allow synthesis of unrelated frequencies
 - Nonvolatile programming for personalization of PLL frequencies, spread spectrum characteristics, drive strength, crystal load capacitance, and output frequencies
 - Application specific programmable EMI reduction using spread spectrum for clocks
 - Programmable PLLs for system frequency margin tests
 - Meets critical timing requirements in complex system designs
 - Suitability for PC, consumer, portable, and networking applications
 - Capable of zero parts per million (PPM) frequency synthesis error
 - Uninterrupted system operation during clock frequency switch
 - Application compatibility in standard and low-power systems
- For a complete list of related documentation, click [here](#).

Block Diagram

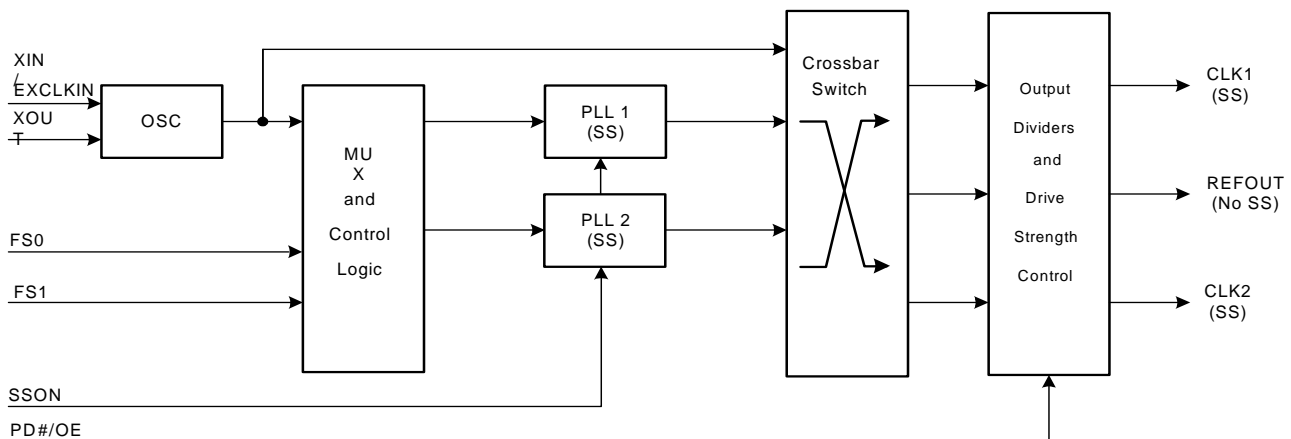

Note

1. The devices mentioned in this datasheet are available as factory-programmable parts and not as field-programmable parts, since the associated programming software is currently not available. Visit www.cypress.com to create a Technical Support case, so Cypress can provide a programming file (.jed file) that matches your requirements.

Contents

Device Selector Guide	3	DC Electrical Specifications	8
Pin Configuration	3	AC Electrical Specifications	9
Pin Definitions	3	Configuration Example	9
Pin Configuration	4	Recommended Crystal Specification	10
Pin Definitions	4	Recommended Crystal Specification	10
Pin Configuration	5	Test and Measurement Setup	10
Pin Definitions	5	Voltage and Timing Definitions	11
Functional Overview	6	Ordering Information	12
Two Configurable PLLs	6	Possible Configurations	12
Input Reference Clocks	6	Ordering Code Definitions	13
VDD Power Supply Options	6	Package Drawing and Dimensions	14
Output Source Selection	6	Acronyms	15
Spread Spectrum Control	6	Document Conventions	15
Frequency Select	6	Units of Measure	15
Glitch-Free Frequency Switch	6	Document History Page	16
PD#/OE Mode	6	Sales, Solutions, and Legal Information	17
Output Drive Strength	6	Worldwide Sales and Design Support	17
Generic Configuration and Custom Frequency	6	Products	17
Absolute Maximum Conditions	7	PSoC® Solutions	17
Recommended Operating Conditions	7	Cypress Developer Community	17
		Technical Support	17

Device Selector Guide

Device	Crystal Input	EXCLKIN Input	V _{DD}
CY25402	Yes	1.8 V LVCMOS	2.5 V, 3.0 V, 3.3 V
CY25482	No	2.5 V, 3.0 V, 3.3 V LVCMOS	2.5 V, 3.0 V, 3.3 V
CY25422	Yes	1.8 V LVCMOS	1.8 V

Pin Configuration

Figure 1. 8-pin SOIC Pinout CY25402

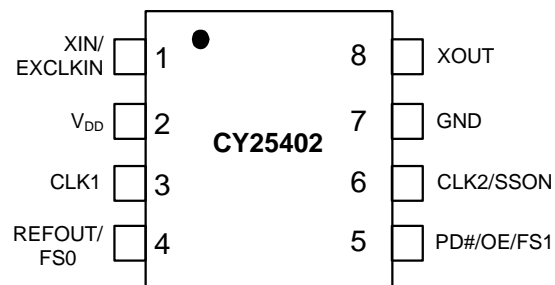

Pin Definitions

CY25402 (2.5 V, 3.0 V, or 3.3 V Supply)

Pin Number	Name	I/O	Description
1	XIN/EXCLKIN	Input	Crystal input or 1.8 V external clock input
2	V _{DD}	Power	Power supply: 2.5 V, 3.0 V, or 3.3 V
3	CLK1	Output	Programmable clock output with spread spectrum
4	REFOUT/FS0	Output/Input	Multifunction programmable pin: reference clock output with no spread spectrum or frequency select pin
5	PD#/OE/FS1	Input	Multifunction programmable pin: power-down, output enable or frequency select pin
6	CLK2/SSON	Output/Input	Multifunction programmable pin: programmable clock output with spread spectrum or spread spectrum ON/OFF control pin
7	GND	Power	Power supply ground
8	XOUT	Output	Crystal output

Pin Configuration

Figure 2. 8-pin SOIC Pinout CY25422

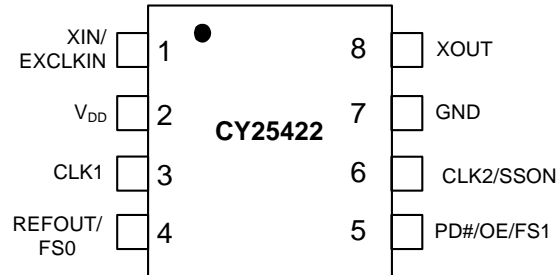

Pin Definitions

CY25422 (1.8 V Supply)

Pin Number	Name	I/O	Description
1	XIN/EXCLKIN	Input	Crystal input or 1.8 V external clock input
2	V _{DD}	Power	Power supply: 1.8 V
3	CLK1	Output	Programmable clock output with spread spectrum
4	REFOUT/FS0	Output/Input	Multifunction programmable pin: reference clock output with no spread spectrum or frequency select pin
5	PD#/OE/FS1	Input	Multifunction programmable pin: power-down, output enable or frequency select pin
6	CLK2/SSON	Output/Input	Multifunction programmable pin: programmable clock output with spread spectrum or spread spectrum ON/OFF control pin
7	GND	Power	Power supply ground
8	XOUT	Output	Crystal output

Pin Configuration

Figure 3. 8-pin SOIC Pinout CY25482

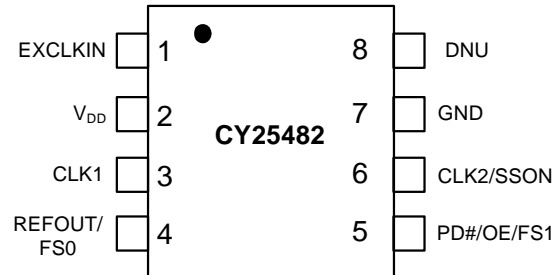

Pin Definitions

CY25482 (2.5 V, 3.0 V, or 3.3 V Supply)

Pin Number	Name	I/O	Description
1	EXCLKIN	Input	2.5 V, 3.0 V, or 3.3 V external clock input
2	V _{DD}	Power	Power supply: 2.5 V, 3.0 V, or 3.3 V
3	CLK1	Output	Programmable clock output with spread spectrum
4	REFOUT/FS0	Output/Input	Multifunction programmable pin: reference clock output with no spread spectrum or frequency select pin
5	PD#/OE/FS1	Input	Multifunction programmable pin: power-down, output enable, or frequency select pin
6	CLK2/SSON	Output/Input	Multifunction Programmable pin: programmable clock output with spread spectrum or spread spectrum ON/OFF control pin
7	GND	Power	Power supply ground
8	DNU	Output	Do not use this pin

Functional Overview

Two Configurable PLLs

The CY25402, CY25422, and CY25482 have two programmable PLLs that can be used to generate output frequencies ranging from 3 to 166 MHz. The advantage of having two PLLs is that a single device generates two independent frequencies from a single crystal.

Input Reference Clocks

The input reference clock can be either a crystal or a clock signal, for CY25402 and CY25422 while just a clock signal for CY25482. The input frequency range for crystal (XIN) is 8 MHz to 48 MHz and that for external reference clock (EXCLKIN) is 8 MHz to 166 MHz. The voltage range of the reference clock input for CY25482 is 2.5 V/3.0 V/3.3 V while that for CY25402 and CY25422 is 1.8 V. This gives user an option for this device to be compatible for different input clock voltage levels in the system.

V_{DD} Power Supply Options

These devices have programmable power supply options. The CY25402/CY25482 is a high voltage part that can be programmed to operate at any voltage 2.5 V, 3.0 V, or 3.3 V while CY25422 is a low voltage part that can operate at 1.8 V.

Output Source Selection

These devices have programmable input sources for each of its clock outputs. There are three available clock sources and these clock sources are: XIN/EXCLKIN, PLL1, and PLL2. Output clock source selection is done by using three out of three crossbar switch. Thus, any one of these three available clock sources can be arbitrarily selected for the clock outputs. This gives user a flexibility to have two independent clock outputs.

Spread Spectrum Control

Both PLLs (PLL1 and PLL2) have spread spectrum capability for EMI reduction in the system. The device uses a Cypress proprietary PLL and spread spectrum clock (SSC) technology to synthesize and modulate the frequency of the PLL. The spread spectrum feature can be turned on or off using a multifunction control pin (CLK2/SSON). It can be programmed to either center spread range from $\pm 0.125\%$ to $\pm 2.50\%$ or down spread range from -0.25% to -5.0% with lexmark or linear profile.

Frequency Select

Each PLL can be programmed for up to four different frequencies. There are two multifunction programmable pins, REFOUT/FS0 and PD#/OE/FS1 which if programmed as frequency select inputs, can be used to select among these arbitrarily programmed frequency settings. Each output has programmable output divider options.

Glitch-Free Frequency Switch

When the frequency select pin, FS(1:0) is used to switch frequency, the outputs are glitch-free provided frequency is switched using output dividers. This feature enables uninterrupted system operation while clock frequency is being switched.

PD#/OE Mode

Multifunction pin PD#/OE/FS1 (Pin 5) can be programmed to operate as either frequency select (FS1), power down (PD#) or output enable (OE) mode. PD# is a low-true input. If activated it shuts off the entire chip, resulting in minimum power consumption for the device. Setting this signal high brings the device in the operational mode with default register settings.

When this pin is programmed as Output Enable (OE), clock outputs can be enabled or disabled using OE (pin 5). Individual clock outputs can be programmed to be sensitive to this OE pin.

Output Drive Strength

The DC drive strength of the individual clock output can be programmed for different values. [Pin Definitions on page 4](#) shows the typical rise and fall times for different drive strength settings.

Table 1. Output Drive Strength

Output Drive Strength	Rise/Fall Time (ns) (Typical Value)
Low	6.8
Mid Low	3.4
Mid High	2.0
High	1.0

Generic Configuration and Custom Frequency

There is a generic set of output frequencies available from the factory that can be used for the device evaluation purposes. The devices, CY25402, CY25422, and CY25482 can be custom programmed to any desired frequencies and listed features. For customer specific programming, contact your local Cypress field application engineer (FAE) or sales representative.

Absolute Maximum Conditions

Parameter	Description	Condition	Min	Max	Unit
V _{DD}	Supply voltage for CY25402/CY25482	–	–0.5	4.5	V
V _{DD}	Supply voltage for CY25422	–	–0.5	2.6	V
V _{IN}	Input voltage for CY25402/CY25482	Relative to V _{SS}	–0.5	V _{DD} + 0.5	V
V _{IN}	Input voltage for CY25422	Relative to V _{SS}	–0.5	2.2	V
T _S	Temperature, storage	Non Functional	–65	+150	°C
ESD _{HBM}	ESD protection (human body model)	JEDEC EIA/JESD22-A114-E	2000	–	V
UL-94	Flammability rating	V-0 at 1/8 in.	–	10	ppm
MSL	Moisture sensitivity level	SOIC package	3		

Recommended Operating Conditions

Parameter	Description	Min	Typ	Max	Unit
V _{DD}	V _{DD} Operating voltage for CY25402/CY25482	2.25	–	3.60	V
V _{DD}	V _{DD} Operating voltage for CY25422	1.65	1.8	1.95	V
T _{AC}	Commercial ambient temperature	0	–	+70	°C
T _{AI}	Industrial ambient temperature	–40	--	+85	°C
C _{LOAD}	Maximum load capacitance	–	–	15	pF
t _{PU}	Power-up time for all V _{DD} to reach minimum specified voltage (power ramps must be monotonic)	0.05	–	500	ms

DC Electrical Specifications

Parameter	Description	Conditions	Min	Typ	Max	Unit
V _{OL}	Output low voltage	I _{OL} = 2 mA, drive strength = [00]	-	-	0.4	V
		I _{OL} = 3 mA, drive strength = [01]				
		I _{OL} = 7 mA, drive strength = [10]				
		I _{OL} = 12 mA, drive strength = [11]				
V _{OH}	Output high voltage	I _{OH} = -2 mA, drive strength = [00]	V _{DD} - 0.4	-	-	V
		I _{OH} = -3 mA, drive strength = [01]				
		I _{OH} = -7 mA, drive strength = [10]				
		I _{OH} = -12 mA, drive strength = [11]				
V _{IL1}	Input low voltage of PD#/OE, FS0, FS1 and SSON	-	-	-	0.2 × V _{DD}	V
V _{IL2}	Input low voltage of EXCLKIN	-	-	-	0.18	V
V _{IH1}	Input High Voltage of PD#/OE, FS0, FS1 and SSON	-	0.8 × V _{DD}	-	-	V
V _{IH2}	Input high voltage of EXCLKIN for CY25402/CY25422	-	1.62	-	2.2	V
V _{IH3}	Input high voltage of EXCLKIN for CY25482	-	0.8 × V _{DD}	-	-	V
I _{IL}	Input low current, PD#/OE/FS1	V _{IN} = 0 V	-	-	10	μA
I _{IH}	Input high current, PD#/OE/FS1	V _{IN} = V _{DD}	-	-	10	μA
I _{ILDN}	Input low current, SSON and FS0 pins	V _{IN} = 0 V (Internal pull down resistor = 160k typ.)	-	-	10	μA
I _{IHDN}	Input high current, SSON and FS0 pins	V _{IN} = V _{DD} (Internal pull down resistor = 160k typ.)	14	-	36	μA
R _{DN}	Pull-down resistor of CLK1, REFOUT/FS0 and CLK2/SSON pins	Output clocks in off state by setting PD# = Low	100	160	250	kΩ
I _{DD} ^[2, 3]	Supply current for CY25422	PD# = High, No load	-	12	-	mA
	Supply current for CY25402/CY25482	PD# = High, No load	-	14	-	mA
I _{DDS} ^[2]	Standby current	PD# = Low	-	3	-	μA
C _{IN} ^[3]	Input capacitance	SSON, PD#/OE/FS1 and FS0 pins	-	-	7	pF

Notes

2. Guaranteed by design but not 100% tested.
3. Configuration dependent.

AC Electrical Specifications

Parameter	Description	Conditions	Min	Typ	Max	Unit
F _{IN} (crystal)	Crystal frequency, XIN		8	–	48	MHz
F _{IN} (clock)	Input clock frequency (EXCLKIN)		8	–	166	MHz
F _{CLK}	Output clock frequency		3	–	166	MHz
DC	Output duty cycle, all clocks except Ref Out	Duty Cycle is defined in Figure 5 on page 11 ; t ₁ /t ₂ , measured at 50% of V _{DD}	45	50	55	%
DC	Ref Out duty cycle	Ref In minimum 45%, maximum 55%	40	–	60	%
T _{RF1} ^[4]	Output rise/fall time	Measured from 20% to 80% of V _{DD} , as shown in Figure 6 on page 11 , C _{LOAD} = 15 pF, drive strength [00]	–	6.8	–	ns
T _{RF2} ^[4]	Output rise/fall time	Measured from 20% to 80% of V _{DD} , as shown in Figure 6 on page 11 , C _{LOAD} = 15 pF, drive strength [01]	–	3.4	–	ns
T _{RF3} ^[4]	Output rise/fall time	Measured from 20% to 80% of V _{DD} , as shown in Figure 6 on page 11 , C _{LOAD} = 15 pF, drive strength [10]	–	2.0	–	ns
T _{RF4} ^[4]	Output rise/fall time	Measured from 20% to 80% of V _{DD} , as shown in Figure 6 on page 11 , C _{LOAD} = 15 pF, drive strength [11]	–	1.0	–	ns
T _{CCJ} ^[4, 5]	Cycle-to-cycle jitter (peak)	Configuration dependent. See Configuration Example	–	100	–	ps
T _{LOCK} ^[5]	PLL lock time	Measured from 90% of the applied power supply level	–	1	3	ms

Configuration Example

For C-C Jitter

Ref. Frequency (MHz)	CLK1 Output		CLK2 Output	
	Freq. (MHz)	C-C Jitter Typ (ps)	Freq. (MHz)	C-C Jitter Typ (ps)
14.3181	8.0	134	48	92
19.2	74.25	99	8	91
27	48	67	166	103
48	48	93	166	137

Notes

4. Guaranteed by design but not 100% tested.
5. Configuration dependent.

Recommended Crystal Specification

For SMD Package

Parameter	Description	Range 1	Range 2	Range 3	Unit
Fmin	Minimum frequency	8	14	28	MHz
Fmax	Maximum frequency	14	28	48	MHz
R1	Motional resistance (ESR)	135	50	30	Ω
C0	Shunt capacitance	4	4	2	pF
CL	Parallel load capacitance	18	14	12	pF
DL(max)	Maximum crystal drive level	300	300	300	μ W

Recommended Crystal Specification

For Thru-Hole Package

Parameter	Description	Range 1	Range 2	Range 3	Unit
Fmin	Minimum frequency	8	14	24	MHz
Fmax	Maximum frequency	14	24	32	MHz
R1	Motional resistance (ESR)	90	50	30	Ω
C0	Shunt capacitance	7	7	7	pF
CL	Parallel load capacitance	18	12	12	pF
DL(max)	Maximum crystal drive level	1000	1000	1000	μ W

Test and Measurement Setup

Figure 4. Test and Measurement Setup

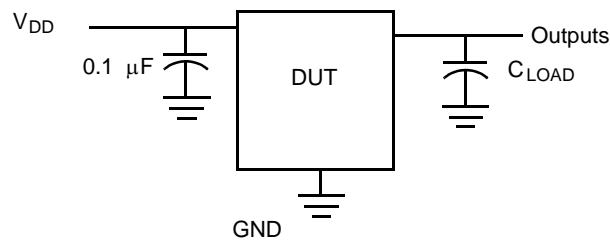

Voltage and Timing Definitions

Figure 5. Duty Cycle Definition

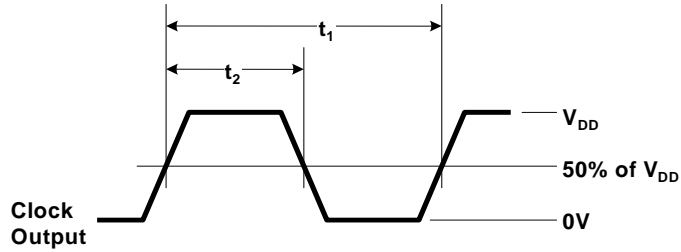
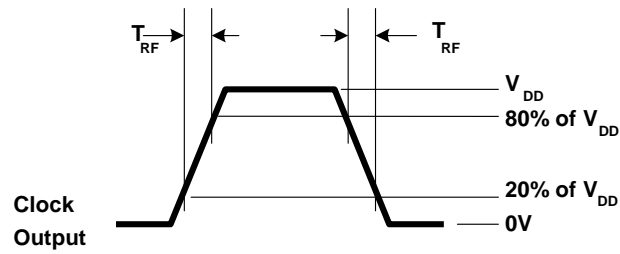

Figure 6. Rise Time = T_{RF} Fall Time = T_{RF}



Ordering Information

Part Number	Type ^[6]	Package	Supply Voltage	Production Flow
Pb-free				
CY25402SXI	Field Programmable	8-pin SOIC	2.5 V, 3.0 V, or 3.3 V	Industrial, -40 °C to +85 °C
CY25402SXIT	Field Programmable	8-pin SOIC – Tape and Reel	2.5 V, 3.0 V, or 3.3 V	Industrial, -40 °C to +85 °C
CY25422FSXI	Field Programmable	8-pin SOIC	1.8 V	Industrial, -40 °C to +85 °C
CY25422FSXIT	Field Programmable	8-pin SOIC – Tape and Reel	1.8 V	Industrial, -40 °C to +85 °C
CY25482FSXI	Field Programmable	8-pin SOIC	2.5 V, 3.0 V, or 3.3 V	Industrial, -40 °C to +85 °C
CY25482FSXIT	Field Programmable	8-pin SOIC – Tape and Reel	2.5 V, 3.0 V, or 3.3 V	Industrial, -40 °C to +85 °C
Programmer				
CY3675-CLKMAKER1	Programming kit			
CY3675-SOIC8A	Socket adapter board for programming CY25402, CY25403, CY25422, CY25423, CY25482, and CY25483			

Some product offerings are factory-programmed customer-specific devices with customized part numbers. The [Possible Configurations](#) table shows the available device types, but not complete part numbers. Contact your local Cypress FAE or sales representative for more information.

Possible Configurations

Part Number ^[7]	Type	Package	Supply Voltage	Production Flow
Pb-free				
CY25402SXC-xxx	Factory Programmed	8-pin SOIC	2.5 V, 3.0 V, or 3.3 V	Commercial, 0 °C to 70 °C
CY25402SXC-xxxT	Factory Programmed	8-pin SOIC – Tape and Reel	2.5 V, 3.0 V, or 3.3 V	Commercial, 0 °C to 70 °C
CY25422SXC-xxx	Factory Programmed	8-pin SOIC	1.8 V	Commercial, 0 °C to 70 °C
CY25422SXC-xxxT	Factory Programmed	8-pin SOIC – Tape and Reel	1.8 V	Commercial, 0 °C to 70 °C
CY25482SXC-xxx	Factory Programmed	8-pin SOIC	2.5 V, 3.0 V, or 3.3 V	Commercial, 0 °C to 70 °C
CY25482SXC-xxxT	Factory Programmed	8-pin SOIC – Tape and Reel	2.5 V, 3.0 V, or 3.3 V	Commercial, 0 °C to 70 °C
CY25402SXI-xxx	Factory Programmed	8-pin SOIC	2.5 V, 3.0 V, or 3.3 V	Industrial, -40 °C to +85 °C
CY25402SXI-xxxT	Factory Programmed	8-pin SOIC – Tape and Reel	2.5 V, 3.0 V, or 3.3 V	Industrial, -40 °C to +85 °C
CY25422SXI-xxx	Factory Programmed	8-pin SOIC	1.8 V	Industrial, -40 °C to +85 °C
CY25422SXI-xxxT	Factory Programmed	8-pin SOIC – Tape and Reel	1.8 V	Industrial, -40 °C to +85 °C
CY25482SXI-xxx	Factory Programmed	8-pin SOIC	2.5 V, 3.0 V, or 3.3 V	Industrial, -40 °C to +85 °C
CY25482SXI-xxxT	Factory Programmed	8-pin SOIC – Tape and Reel	2.5 V, 3.0 V, or 3.3 V	Industrial, -40 °C to +85 °C

Notes

- The devices mentioned in this datasheet are available as factory-programmable parts and not as field-programmable parts, since the associated programming software is currently not available. Visit www.cypress.com to create a Technical Support case, so Cypress can provide a programming file (.jed file) that matches your requirements.
- xxx indicates Factory Programmable and are factory programmed configurations. For more details, contact your local Cypress FAE or sales representative.

Ordering Code Definitions

CY 254x2 X S X X - xxx X

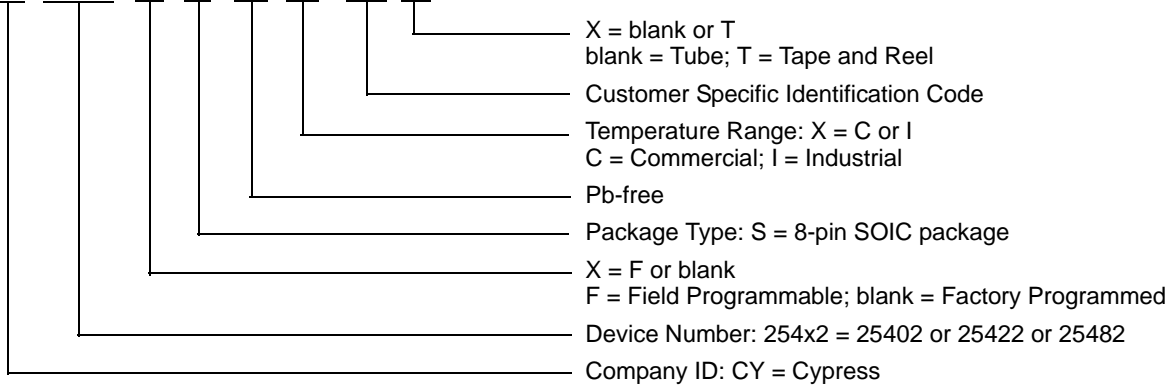

Package Drawing and Dimensions

Figure 7. 8-pin SOIC (150 Mils) Package Outline, 51-85066

1. DIMENSIONS IN INCHES[MM] MIN. MAX.
2. PIN 1 ID IS OPTIONAL, ROUND ON SINGLE LEADFRAME RECTANGULAR ON MATRIX LEADFRAME
3. REFERENCE JEDEC MS-012
4. PACKAGE WEIGHT 0.07gms

PART #	
S08.15	STANDARD PKG
SZ08.15	LEAD FREE PKG
SW8.15	LEAD FREE PKG

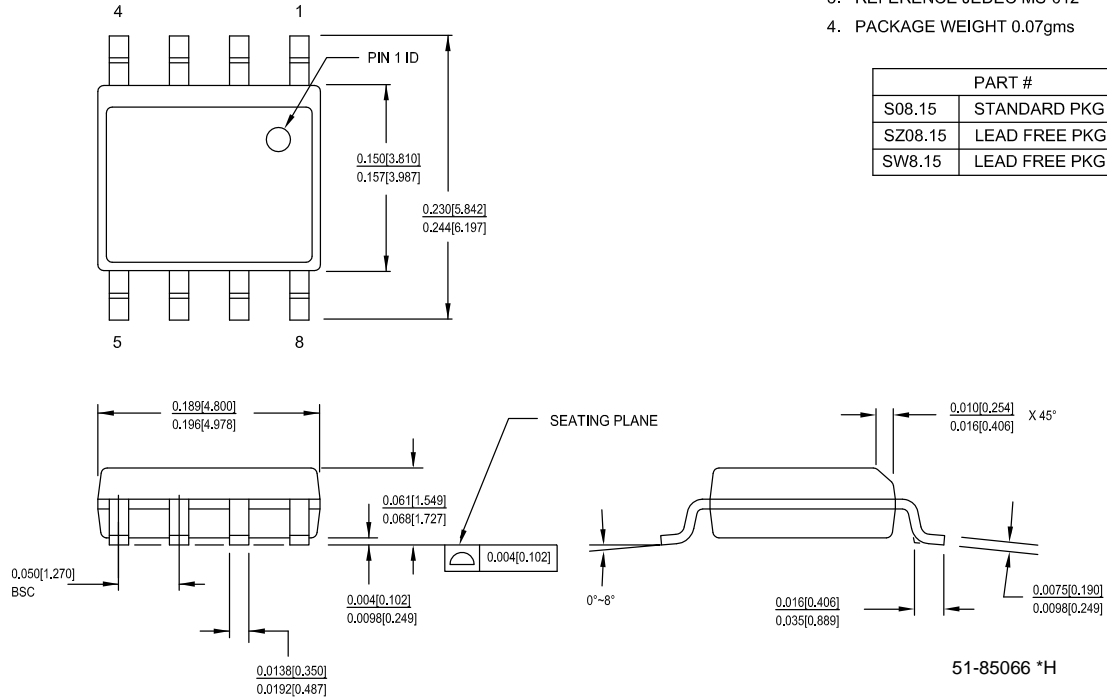

Acronyms

Acronym	Description
DL	Drive Level
DNU	Do Not Use
DUT	Device Under Test
EIA	Electronic Industries Alliance
EMI	Electromagnetic Interference
ESD	Electrostatic Discharge
FAE	Field Application Engineer
FS	Frequency Select
JEDEC	Joint Electron Devices Engineering Council
LVC MOS	Low Voltage Complementary Metal Oxide Semiconductor
OE	Output Enable
OSC	Oscillator
PD	Power Down
PLL	Phase-Locked Loop
PPM	Parts Per Million
SS	Spread Spectrum
SSC	Spread Spectrum Clock
SSON	Spread Spectrum On

Document Conventions

Units of Measure

Symbol	Unit of Measure
°C	degrees Celsius
fF	femtofarad
MHz	megahertz
μs	microsecond
μW	microwatt
mA	milliampere
ms	millisecond
ns	nanosecond
Ω	ohm
pF	picofarad
ppm	parts per million
ps	picosecond
V	volt
W	watt

Document History Page

Document Title: CY25402/CY25422/CY25482, Two-PLL Programmable Clock Generator with Spread Spectrum				
Document Number: 001-12565				
Rev.	ECN No.	Issue Date	Orig. of Change	Description of Change
**	690296	See ECN	RGL	New data sheet.
*A	815788	See ECN	RGL	Minor Change: To post on web
*B	1428744	See ECN	RGL / AESA	<p>Changed status from Preliminary to Final.</p> <p>Added CY25482 part related information in all instances across the document.</p> <p>Replaced "CLK2" with "REFOUT" in all instances across the document.</p> <p>Updated Block Diagram.</p> <p>Updated Functional Overview.</p> <p>Updated Absolute Maximum Conditions.</p> <p>Updated Recommended Operating Conditions.</p> <p>Updated DC Electrical Specifications.</p> <p>Updated Ordering Information:</p> <p>Updated part numbers.</p> <p>Updated to new template.</p>
*C	2748211	08/10/09	TSAI	Posting to external web.
*D	2898568	06/02/10	KVM	<p>Updated Ordering Information:</p> <p>Updated part numbers.</p> <p>Added Possible Configurations.</p> <p>Moved 'xxx' parts to Possible Configurations table.</p> <p>Updated Package Drawing and Dimensions:</p> <p>spec 51-85066 – Changed revision from *C to *D.</p> <p>Updated to new template.</p>
*E	3110175	12/14/2010	BASH	<p>Added Units of Measure.</p> <p>Updated to new template.</p>
*F	3235621	04/20/2011	CXQ	<p>Updated Ordering Information:</p> <p>Updated part numbers.</p>
*G	4219507	12/13/2013	CINM	<p>Updated Ordering Information:</p> <p>Updated part numbers.</p> <p>Updated Package Drawing and Dimensions:</p> <p>spec 51-85066 – Changed revision from *D to *F.</p> <p>Updated to new template.</p> <p>Completing Sunset Review.</p>
*H	4473684	08/25/2014	TAVA	<p>Updated Features:</p> <p>Added Note 1 and referred the same note next to "Programmable".</p> <p>Updated Ordering Information:</p> <p>No change in part numbers.</p> <p>Added Note 6 and referred the same note in "Type" column.</p>
*I	4586478	12/03/2014	AJU	<p>Updated For a complete list of related documentation, click here.:</p> <p>Added "For a complete list of related documentation, click here." at the end.</p>
*J	5590046	01/17/2017	TAVA	<p>Updated Package Drawing and Dimensions:</p> <p>spec 51-85066 – Changed revision from *F to *H.</p> <p>Updated to new template.</p> <p>Completing Sunset Review.</p>
*K	5726617	05/18/2017	BPIN	<p>Updated Ordering Information.</p> <p>Updated Cypress logo, Sales page, and Copyright information.</p>
*L	5778002	06/19/2017	PSR	<p>Added one-time programmability</p> <p>Added spread capability information for outputs</p>

Sales, Solutions, and Legal Information

Worldwide Sales and Design Support

Cypress maintains a worldwide network of offices, solution centers, manufacturer's representatives, and distributors. To find the office closest to you, visit us at [Cypress Locations](#).

Products

ARM® Cortex® Microcontrollers	cypress.com/arm
Automotive	cypress.com/automotive
Clocks & Buffers	cypress.com/clocks
Interface	cypress.com/interface
Internet of Things	cypress.com/iot
Memory	cypress.com/memory
Microcontrollers	cypress.com/mcu
PSoC	cypress.com/psoc
Power Management ICs	cypress.com/pmic
Touch Sensing	cypress.com/touch
USB Controllers	cypress.com/usb
Wireless Connectivity	cypress.com/wireless

PSoC® Solutions

[PSoC 1](#) | [PSoC 3](#) | [PSoC 4](#) | [PSoC 5LP](#) | [PSoC 6](#)

Cypress Developer Community

[Forums](#) | [WICED IOT Forums](#) | [Projects](#) | [Video](#) | [Blogs](#) | [Training](#) | [Components](#)

Technical Support

cypress.com/support

© Cypress Semiconductor Corporation, 2006-2017. This document is the property of Cypress Semiconductor Corporation and its subsidiaries, including Spansion LLC ("Cypress"). This document, including any software or firmware included or referenced in this document ("Software"), is owned by Cypress under the intellectual property laws and treaties of the United States and other countries worldwide. Cypress reserves all rights under such laws and treaties and does not, except as specifically stated in this paragraph, grant any license under its patents, copyrights, trademarks, or other intellectual property rights. If the Software is not accompanied by a license agreement and you do not otherwise have a written agreement with Cypress governing the use of the Software, then Cypress hereby grants you a personal, non-exclusive, nontransferable license (without the right to sublicense) (1) under its copyright rights in the Software (a) for Software provided in source code form, to modify and reproduce the Software solely for use with Cypress hardware products, only internally within your organization, and (b) to distribute the Software in binary code form externally to end users (either directly or indirectly through resellers and distributors), solely for use on Cypress hardware product units, and (2) under those claims of Cypress's patents that are infringed by the Software (as provided by Cypress, unmodified) to make, use, distribute, and import the Software solely for use with Cypress hardware products. Any other use, reproduction, modification, translation, or compilation of the Software is prohibited.

TO THE EXTENT PERMITTED BY APPLICABLE LAW, CYPRESS MAKES NO WARRANTY OF ANY KIND, EXPRESS OR IMPLIED, WITH REGARD TO THIS DOCUMENT OR ANY SOFTWARE OR ACCOMPANYING HARDWARE, INCLUDING, BUT NOT LIMITED TO, THE IMPLIED WARRANTIES OF MERCHANTABILITY AND FITNESS FOR A PARTICULAR PURPOSE. To the extent permitted by applicable law, Cypress reserves the right to make changes to this document without further notice. Cypress does not assume any liability arising out of the application or use of any product or circuit described in this document. Any information provided in this document, including any sample design information or programming code, is provided only for reference purposes. It is the responsibility of the user of this document to properly design, program, and test the functionality and safety of any application made of this information and any resulting product. Cypress products are not designed, intended, or authorized for use as critical components in systems designed or intended for the operation of weapons, weapons systems, nuclear installations, life-support devices or systems, other medical devices or systems (including resuscitation equipment and surgical implants), pollution control or hazardous substances management, or other uses where the failure of the device or system could cause personal injury, death, or property damage ("Unintended Uses"). A critical component is any component of a device or system whose failure to perform can be reasonably expected to cause the failure of the device or system, or to affect its safety or effectiveness. Cypress is not liable, in whole or in part, and you shall and hereby do release Cypress from any claim, damage, or other liability arising from or related to all Unintended Uses of Cypress products. You shall indemnify and hold Cypress harmless from and against all claims, costs, damages, and other liabilities, including claims for personal injury or death, arising from or related to any Unintended Uses of Cypress products.

Cypress, the Cypress logo, Spansion, the Spansion logo, and combinations thereof, WICED, PSoC, CapSense, EZ-USB, F-RAM, and Traveo are trademarks or registered trademarks of Cypress in the United States and other countries. For a more complete list of Cypress trademarks, visit cypress.com. Other names and brands may be claimed as property of their respective owners.