

## 阅读申明

- 1.本站收集的数据手册和产品资料都来自互联网，版权归原作者所有。如读者和版权方有任何异议请及时告之，我们将妥善解决。
- 2.本站提供的中文数据手册是英文数据手册的中文翻译，其目的是协助用户阅读，该译文无法自动跟随原稿更新，同时也可能存在翻译上的不当。建议读者以英文原稿为参考以便获得更精准的信息。
- 3.本站提供的产品资料，来自厂商的技术支持或者使用者的心得体会等，其内容可能存在描述上的差异，建议读者做出适当判断。
- 4.如需与我们联系，请发邮件到marketing@iczoom.com，主题请标有“数据手册”字样。

## Read Statement

1. The datasheets and other product information on the site are all from network reference or other public materials, and the copyright belongs to the original author and original published source. If readers and copyright owners have any objections, please contact us and we will deal with it in a timely manner.
2. The Chinese datasheets provided on the website is a Chinese translation of the English datasheets. Its purpose is for reader's learning exchange only and do not involve commercial purposes. The translation cannot be automatically updated with the original manuscript, and there may also be improper translations. Readers are advised to use the English manuscript as a reference for more accurate information.
3. All product information provided on the website refer to solutions from manufacturers' technical support or users the contents may have differences in description, and readers are advised to take the original article as the standard.
4. If you have any questions, please contact us at marketing@iczoom.com and mark the subject with "Datasheets" .





# PL502-35/-37/-38/-39

## 750kHz – 800MHz Low Phase Noise Multiplier VCXO

Universal Low Phase Noise ICs

### FREQUENCY SELECTION TABLE

SEL3	SEL2	SEL1	SEL0	Selected Multiplier
0	0	1	1	Fin x 32
0	1	1	0	Fin / 8
0	1	1	1	Fin x 2
1	0	0	1	Fin / 2
1	0	1	0	Fin / 16
1	0	1	1	Fin x 4
1	1	0	0	Fin / 4
1	1	0	1	Fin x 8
1	1	1	0	Fin x 16
1	1	1	1	No multiplication

Note: SEL0 is not available (always "1") for PL502-35 and PL502-38 in 3x3mm package

### PIN DESCRIPTIONS PL502-35 and PL502-38 (see next page for PL502-37/-39)

Name	TSSOP Pin number	3x3mm QFN Pin number	Type	Description
XIN	2	12	I	Crystal input (See Crystal Specification on page 4)
XOUT	3	13	I	Crystal output (See Crystal Specification on page 4)
OE	6	16	I	Output enable pin (See OE logic state table on page 1)
VCON	7	1	I	Voltage Control input
GND	8,9,10,14	2,3,4,8,11	P	Ground connection
CLKT	11	5	O	LVPECL True output
CLKC	13	7	O	LVPECL Complementary output
SEL0	16	Not available	I	Multiplier selector pins. These pins have an internal pull-up that will default SEL to '1' when not connected to GND.
SEL1	15	9	I	
SEL2	5	15	I	
SEL3	4	14	I	
VDD	1, 12	6,10	P	+3.3V power supply.

## 750kHz – 800MHz Low Phase Noise Multiplier VCXO

Universal Low Phase Noise ICs

### PIN DESCRIPTIONS PL502-37/-39 (see previous page for PL502-35/-38)

Name	TSSOP Pin number	3x3mm QFN Pin number	Type	Description
XIN	2	12	I	Crystal input. See Crystal Specification on page 4.
XOUT	3	13	I	Crystal output. See Crystal Specification on page 4.
OE	6	16	I	Output enable pin (see OE logic state table on page 1).
VCON	7	1	I	Voltage Control input.
GND	8,9,10,14	2,3,4,8	P	Ground.
CLKT	11	5	O	LVDS True output for PL502-39 No Connect for PL502-37
CLKC	13	7	O	LVDS Complementary output for PL502-39 LVCMOS out for PL502-37
SEL0	16	10	I	Multiplier selector pins. These pins have an internal pull-up that will default SELx to '1' when not connected to GND.
SEL1	15	9	I	
SEL2	5	15	I	
SEL3	4	14	I	
VDD	1, 12	6,11	P	+3.3V power supply.

## ELECTRICAL SPECIFICATIONS

### 1. Absolute Maximum Ratings

PARAMETERS	SYMBOL	MIN.	MAX.	UNITS
Supply Voltage	$V_{DD}$		4.6	V
Input Voltage, dc	$V_I$	-0.5	$V_{DD}+0.5$	V
Output Voltage, dc	$V_O$	-0.5	$V_{DD}+0.5$	V
Storage Temperature	$T_S$	-65	150	°C
Ambient Operating Temperature*	$T_A$	-40	85	°C
Junction Temperature	$T_J$		125	°C
Lead Temperature (soldering, 10s)			260	°C
ESD Protection, Human Body Model			2.5	kV

Exposure of the device under conditions beyond the limits specified by Maximum Ratings for extended periods may cause permanent damage to the device and affect product reliability. These conditions represent a stress rating only, and functional operations of the device at these or any other conditions above the operational limits noted in this specification is not implied.

\* **Note:** Operating Temperature is guaranteed by design for all parts (COMMERCIAL and INDUSTRIAL), but tested for COMMERCIAL grade only.

**750kHz – 800MHz Low Phase Noise Multiplier VCXO**

Universal Low Phase Noise ICs

**2. Crystal Specifications**

PARAMETERS	SYMBOL	CONDITIONS	MIN.	TYP.	MAX.	UNITS
Crystal Resonator Frequency	$F_{XIN}$	Parallel Fundamental Mode	12		25	MHz
Crystal Loading Rating	$C_{L(xtal)}$	At $V_{CON} = 1.65V$		9.5		pF
Crystal Pullability	$C_0/C_1(xtal)$	AT cut			250	-
Recommended ESR	$R_E$	AT cut			30	$\Omega$

**Note:** Crystal Loading rating: 9.5pF is the loading the crystal sees from the VCXO chip at  $V_{CON} = 1.65V$ . It is assumed that the crystal will be at nominal frequency at this load. If the crystal requires more load to be at nominal frequency, the additional load must be added externally. This however may reduce the pull range.

**3. Voltage Control Crystal Oscillator**

PARAMETERS	SYMBOL	CONDITIONS	MIN.	TYP.	MAX.	UNITS
VCXO Stabilization Time *	$T_{VCXOSTB}$	From power valid			10	ms
VCXO Tuning Range		$F_{XIN} = 12 - 25MHz$ ; $XTAL C_0/C_1 < 250$ $0V \leq V_{CON} \leq 3.3V$		500		ppm
CLK output pullability		$V_{CON} = 1.65V, \pm 1.65V$	$\pm 200$			ppm
VCXO Tuning Characteristic				150		ppm/V
Pull range linearity					10	%
VCON pin input impedance			2000			k $\Omega$
VCON modulation BW		$0V \leq V_{CON} \leq 3.3V, -3dB$	10			kHz

**Note:** Parameters denoted with an asterisk (\*) represent nominal characterization data and are not production tested to any specific limits.

**4. General Electrical Specifications**

PARAMETERS	SYMBOL	CONDITIONS	MIN.	TYP.	MAX.	UNITS	
Supply Current, Dynamic (with Loaded Outputs)	$I_{DD}$	LVPECL/LVDS/LVCMOS	$F_{OUT} < 24MHz$			60/28/15	mA
			$24MHz < F_{OUT} < 96MHz$			65/45/30	
			$96MHz < F_{OUT} < 800MHz$			100/80/40	
Operating Voltage	$V_{DD}$		2.97		3.63	V	
Output Clock Duty Cycle		@ 50% $V_{DD}$ (LVCMOS)	45	50	55	%	
		@ 1.25V (LVDS)	45	50	55		
		@ $V_{DD} - 1.3V$ (LVPECL)	45	50	55		
Short Circuit Current				$\pm 50$		mA	

**750kHz – 800MHz Low Phase Noise Multiplier VCXO**

Universal Low Phase Noise ICs

**5. Jitter Specifications**

PARAMETERS	CONDITIONS	FREQUENCY	MIN.	TYP.	MAX.	UNITS
Period jitter RMS	With capacitive decoupling between V <sub>DD</sub> and GND. Over 10,000 cycles.	19.44MHz		2.2		ps
		77.76MHz		4.5		
		155.52MHz		4.5		
		622.08MHz		5.0		
Period jitter Peak-to-Peak	With capacitive decoupling between V <sub>DD</sub> and GND. Over 10,000 cycles.	19.44MHz		17		ps
		77.76MHz		25		
		155.52MHz		27		
		622.08MHz		35		
Integrated jitter RMS	Integrated 12kHz to 20MHz	155.52MHz		2.5	4	ps
		622.08MHz		2.5	4	

**6. Phase Noise Specifications**

PARAMETERS	FREQUENCY	@10Hz	@100Hz	@1kHz	@10kHz	@100kHz	UNITS
Phase Noise relative to carrier (typical)	19.44MHz	-80	-108	-132	-142	-150	dBc/Hz
	77.76MHz	-72	-103	-122	-130	-125	
	155.52MHz	-65	-95	-120	-125	-121	
	622.08MHz	-55	-85	-109	-115	-110	

Note: Phase Noise measured at VCON = 0V

**7. LVCMOS Electrical Characteristics**

PARAMETERS	SYMBOL	CONDITIONS	MIN.	TYP.	MAX.	UNITS
Output drive current	I <sub>OH</sub>	V <sub>OH</sub> = V <sub>DD</sub> -0.4V, V <sub>DD</sub> =3.3V	10			mA
	I <sub>OL</sub>	V <sub>OL</sub> = 0.4V, V <sub>DD</sub> = 3.3V	10			mA
Output Clock Rise/Fall Time		0.3V ~ 3.0V with 15 pF load		2.4		ns

## 750kHz – 800MHz Low Phase Noise Multiplier VCXO

Universal Low Phase Noise ICs

### 8. LVDS Electrical Characteristics

PARAMETERS	SYMBOL	CONDITIONS	MIN.	TYP.	MAX.	UNITS
Output Differential Voltage	$V_{OD}$	$R_L = 100\Omega$ (see figure)	247	355	454	mV
$V_{DD}$ Magnitude Change	$\Delta V_{OD}$		-50		50	mV
Output High Voltage	$V_{OH}$			1.4	1.6	V
Output Low Voltage	$V_{OL}$		0.9	1.1		V
Offset Voltage	$V_{OS}$		1.125	1.2	1.375	V
Offset Magnitude Change	$\Delta V_{OS}$		0	3	25	mV
Power-off Leakage	$I_{OXD}$	$V_{out} = V_{DD}$ or GND $V_{DD} = 0V$		$\pm 1$	$\pm 10$	$\mu A$
Output Short Circuit Current	$I_{OSD}$			-5.7	-8	mA

### 9. LVDS Switching Characteristics

PARAMETERS	SYMBOL	CONDITIONS	MIN.	TYP.	MAX.	UNITS
Differential Clock Rise Time	$t_r$	$R_L = 100\Omega$ $C_L = 10\text{ pF}$ (see figure)	0.2	0.7	1.0	ns
Differential Clock Fall Time	$t_f$		0.2	0.7	1.0	ns

LVDS Levels Test Circuit

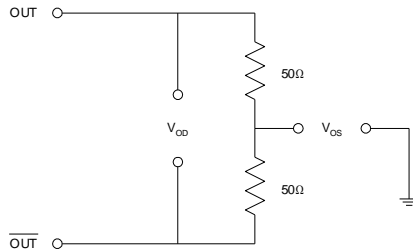

LVDS Switching Test Circuit

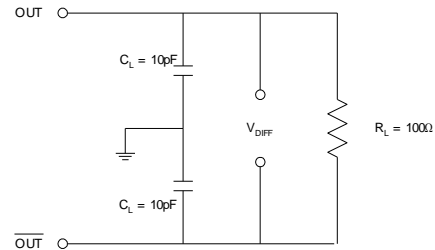

LVDS Transition Time Waveform

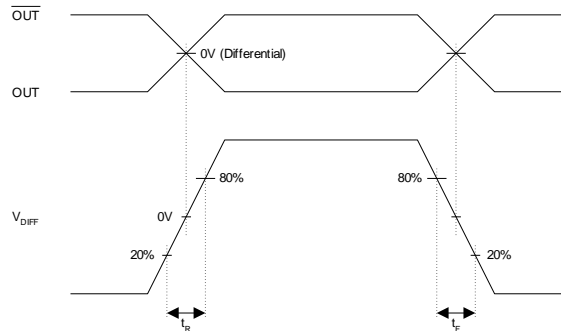

## 750kHz – 800MHz Low Phase Noise Multiplier VCXO

Universal Low Phase Noise ICs

### 10. LVPECL Electrical Characteristics

PARAMETERS	SYMBOL	CONDITIONS	MIN.	MAX.	UNITS
Output High Voltage	$V_{OH}$	$R_L = 50\Omega$ to $(V_{DD} - 2V)$ (see figure)	$V_{DD} - 1.025$		V
Output Low Voltage	$V_{OL}$			$V_{DD} - 1.620$	V

### 11. LVPECL Switching Characteristics

PARAMETERS	SYMBOL	CONDITIONS	MIN.	TYP.	MAX.	UNITS
Clock Rise Time	$t_r$	20%~80% of Waveform		0.6	1.5	ns
Clock Fall Time	$t_f$			0.6	1.5	ns

LVPECL Levels Test Circuit

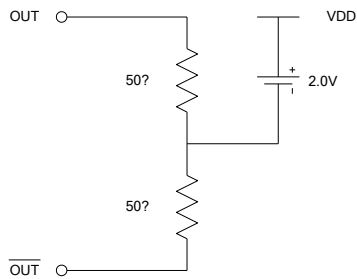

LVPECL Output Skew

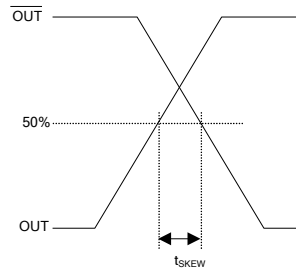

LVPECL Transition Time Waveform

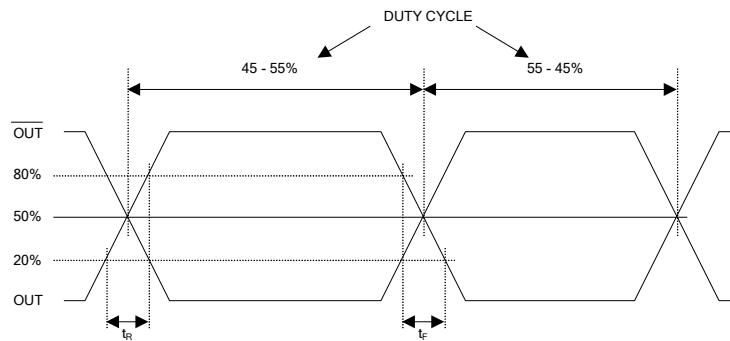



## 750kHz – 800MHz Low Phase Noise Multiplier VCXO

Universal Low Phase Noise ICs

### PACKAGE INFORMATION (GREEN PACKAGE COMPLIANT)

#### TSSOP-16L

Symbol	Dimension in MM	
	Min.	Max.
A	-	1.20
A1	0.05	0.15
b	0.19	0.30
C	0.09	0.20
D	4.90	5.10
E	4.30	4.50
H	6.20	6.60
L	0.45	0.75
e	0.65 BSC	

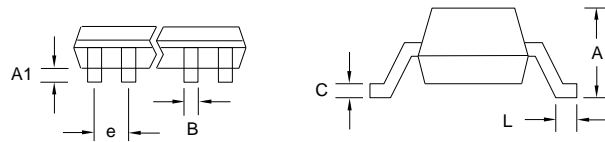
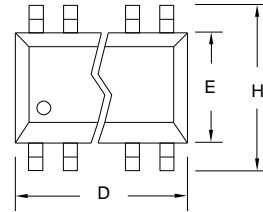

#### QFN-16L

Symbol	Dimension (mm)		
	Min	Nom	Max
A	0.70	0.75	0.80
A1	0.00	-	0.05
A3	0.203		
b	0.20	0.25	0.30
D	2.95	3.00	3.05
E	2.95	3.00	3.05
D1	1.65	1.70	1.75
E1	1.65	1.70	1.75
L	0.250	0.300	0.350
e	0.50BSC		

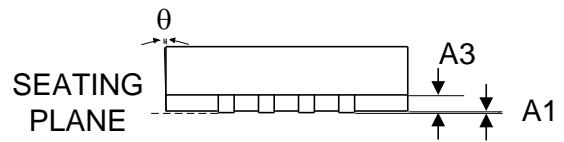
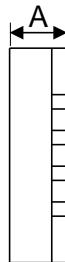
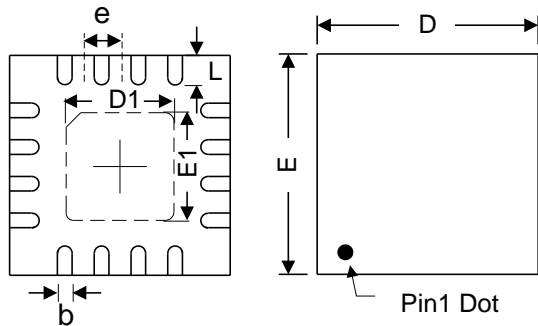

## 750kHz – 800MHz Low Phase Noise Multiplier VCXO

Universal Low Phase Noise ICs

### ORDERING INFORMATION

**For part ordering, please contact our Sales Department:**

2180 Fortune Drive, San Jose, CA 95131, USA

Tel: (408) 944-0800 Fax: (408) 474-1000

#### PART NUMBER

The order number for this device is a combination of the following:

Part number, Package type, Operating temperature range, shipping method

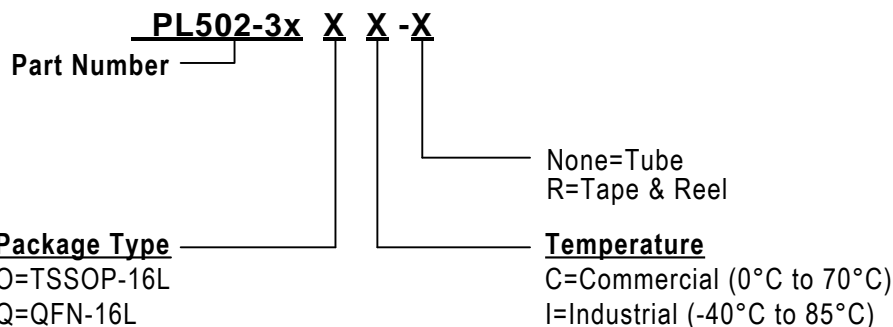

Part/Order Number*	Marking**		Package Option
	Commercial	Industrial	
PL502-35OC	P502-35 OC	P502-35 OI	8-pin TSSOP-16L – (Tube)
PL502-35OC-R	LLLLL	LLLLL	8-pin TSSOP-16L – (Tape and Reel)
PL502-35QC-R	P502 35 LLL	P502 35I LLL	16-pin QFN-16L - (Tape and Reel)
PL502-37OC	P502-37 OC	P502-37 OI	8-pin TSSOP-16L – (Tube)
PL502-37OC-R	LLLLL	LLLLL	8-pin TSSOP-16L – (Tape and Reel)
PL502-37QC-R	P502 37 LLL	P502 37I LLL	16-pin QFN-16L - (Tape and Reel)
PL502-38OC	P502-38 OC	P502-38 OI	8-pin TSSOP-16L – (Tube)
PL502-38OC-R	LLLLL	LLLLL	8-pin TSSOP-16L – (Tape and Reel)
PL502-38QC-R	P502 38 LLL	P502 38I LLL	16-pin QFN-16L - (Tape and Reel)
PL502-39OC	P502-39 OC	P502-39 OI	8-pin TSSOP-16L – (Tube)
PL502-39OC-R	LLLLL	LLLLL	8-pin TSSOP-16L – (Tape and Reel)
PL502-39QC-R	P502 39 LLL	P502 39I LLL	16-pin QFN-16L - (Tape and Reel)

\*Note: For Industrial use "I" instead of "C" in the Part/Order number.

\*\*Note: "LLL" or "LLLLL" are designates lot number



# PL502-35/-37/-38/-39

---

## 750kHz – 800MHz Low Phase Noise Multiplier VCXO

Universal Low Phase Noise ICs

*Micrel Inc., reserves the right to make changes in its products or specifications, or both at any time without notice. The information furnished by Micrel is believed to be accurate and reliable. However, Micrel makes no guarantee or warranty concerning the accuracy of said information and shall not be responsible for any loss or damage of whatever nature resulting from the use of, or reliance upon this product.*

**LIFE SUPPORT POLICY:** *Micrel's products are not authorized for use as critical components in life support devices or systems without the express written approval of the President of Micrel Inc.*