

阅读申明

- 1.本站收集的数据手册和产品资料都来自互联网，版权归原作者所有。如读者和版权方有任何异议请及时告之，我们将妥善解决。
- 2.本站提供的中文数据手册是英文数据手册的中文翻译，其目的是协助用户阅读，该译文无法自动跟随原稿更新，同时也可能存在翻译上的不当。建议读者以英文原稿为参考以便获得更精准的信息。
- 3.本站提供的产品资料，来自厂商的技术支持或者使用者的心得体会等，其内容可能存在描述上的差异，建议读者做出适当判断。
- 4.如需与我们联系，请发邮件到marketing@iczoom.com，主题请标有“数据手册”字样。

Read Statement

1. The datasheets and other product information on the site are all from network reference or other public materials, and the copyright belongs to the original author and original published source. If readers and copyright owners have any objections, please contact us and we will deal with it in a timely manner.
2. The Chinese datasheets provided on the website is a Chinese translation of the English datasheets. Its purpose is for reader's learning exchange only and do not involve commercial purposes. The translation cannot be automatically updated with the original manuscript, and there may also be improper translations. Readers are advised to use the English manuscript as a reference for more accurate information.
3. All product information provided on the website refer to solutions from manufacturers' technical support or users the contents may have differences in description, and readers are advised to take the original article as the standard.
4. If you have any questions, please contact us at marketing@iczoom.com and mark the subject with "Datasheets" .



FEATURES

- ◆ Ultra Low Supply Current: 1µA at 25kHz
- ◆ Supply Voltage Operation: 0.9V to 1.8V
- ◆ Programmable Frequency Range:
 - 5.2kHz ≤ FOUT ≤ 90kHz
- ◆ FOUT Period Drift: 0.021%/°C
- ◆ PWMOUT Duty Cycle Range: 12% to 90%
- ◆ Single Resistor Sets Output Frequency
- ◆ Output Driver Resistance: 160Ω

APPLICATIONS

- Portable and Battery-Powered Equipment
- Low-Parts-Count Nanopower Oscillator
- Compact Nanopower Replacement for Crystal and Ceramic Oscillators
- Nanopower Pulse-width Modulation Control
- Nanopower Pulse-position Modulation Control
- Nanopower Clock Generation
- Nanopower Sequential Timing

DESCRIPTION

The TS3001 is a single-supply CMOS oscillator fully specified to operate at 1V while consuming a 1µA supply current at an output frequency of 25kHz. This oscillator is compact, easy-to-use, and versatile. Optimized for ultra-long life, battery-powered applications, the TS3001 joins the TS3002 CMOS oscillator in the “NanoWatt Analog™” high-performance analog integrated circuits portfolio. The TS3001 can operate from single-supply voltages from 0.9V to 1.8V.

Requiring only a resistor to set the output frequency, the TS3001 represents a 66% reduction in pcb area and a factor-of-10 reduction in power consumption over other CMOS-based integrated circuit oscillators. When compared against industry-standard 555-timer-based products, the TS3001 offers up to 93% reduction in pcb area and four orders of magnitude lower power consumption.

The TS3001 is fully specified over the -40°C to +85°C temperature range and is available in a low-profile, 8-pin 2x2mm TDFN package with an exposed back-side paddle.

TYPICAL APPLICATION CIRCUIT

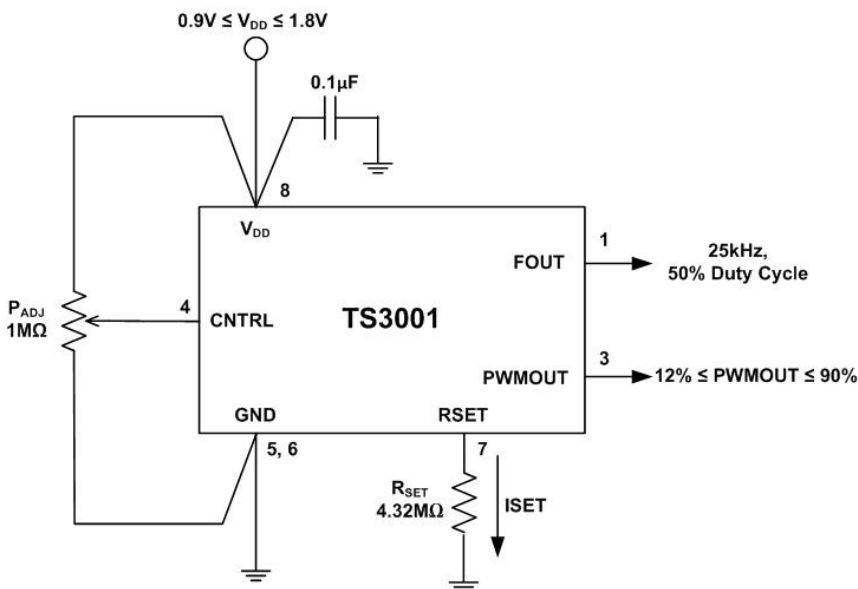

Table 1: FOUT vs RSET

R _{SET} (MΩ)	F _{OUT} (kHz)
1	110
2.49	44
4.32	25.5
6.81	16
9.76	11

ABSOLUTE MAXIMUM RATINGS

V_{DD} to GND.....-0.3V to +2V
 V_{CNTRL} to GND.....-0.3V to +2V
 RSET to GND.....-0.3V to +2V
 FOUT, PWMOUT to GND.....-0.3V to +2V
 Short Circuit Duration FOUT, PWMOUT to GND or V_{DD}
 Continuous

Continuous Power Dissipation ($T_A = +70^\circ\text{C}$)
 8-Pin TDFN (Derate at 23.8mW/ $^\circ\text{C}$ above $+70^\circ\text{C}$)..... 1951mW
 Operating Temperature Range..... -40°C to $+85^\circ\text{C}$
 Storage Temperature Range..... -65°C to $+150^\circ\text{C}$
 Lead Temperature (Soldering, 10s)..... $+300^\circ\text{C}$

Electrical and thermal stresses beyond those listed under “Absolute Maximum Ratings” may cause permanent damage to the device. These are stress ratings only and functional operation of the device at these or any other condition beyond those indicated in the operational sections of the specifications is not implied. Exposure to any absolute maximum rating conditions for extended periods may affect device reliability and lifetime.

PACKAGE/ORDERING INFORMATION

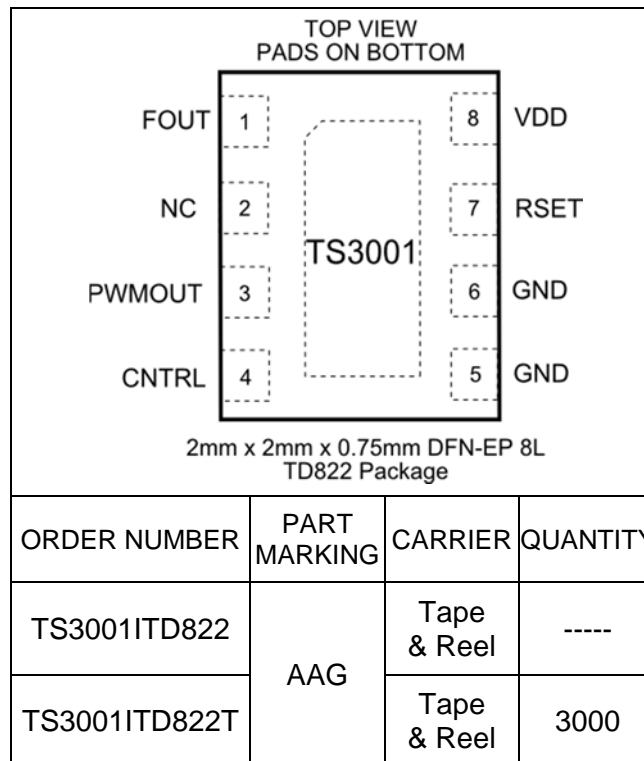

Lead-free Program: Silicon Labs supplies only lead-free packaging.

Consult Silicon Labs for products specified with wider operating temperature ranges.



ELECTRICAL CHARACTERISTICS

$V_{DD} = 1V$, $V_{CNTRL} = V_{DD}$, $R_{SET} = 4.32M\Omega$, $R_{LOAD(FOUT)} = \text{Open Circuit}$, $C_{LOAD(FOUT)} = 0pF$, $C_{LOAD(PWM)} = 0pF$ unless otherwise noted. Values are at $T_A = 25^\circ C$ unless otherwise noted. See Note 1.

PARAMETER	SYMBOL	CONDITIONS	MIN	TYP	MAX	UNITS
Supply Voltage	V_{DD}		0.9	1	1.8	V
Supply Current	I_{DD}			1	1.5	μA
		$-40^\circ C \leq T_A \leq 85^\circ C$			2.8	
		$V_{CNTRL} = 0.15 \times V_{DD}$		2.1	3.7	
FOUT Period	t_{FOUT}		38.5		41.6	μs
		$-40^\circ C \leq T_A \leq 85^\circ C$	36.8		44.6	
FOUT Period Line Regulation	$\Delta t_{FOUT}/V$	$1V \leq V_{DD} \leq 1.8V$		1.8		%/V
FOUT Period Temperature Coefficient	$\Delta t_{FOUT}/\Delta T$			0.021		%/°C
PWMOUT Duty Cycle	DC(PWMOUT)	$V_{CNTRL} = 0.03 \times V_{DD}$	6	10.5	15	%
		$V_{CNTRL} = 0.15 \times V_{DD}$	45	49.8	54.2	
		$V_{CNTRL} = 0.27 \times V_{DD}$	84	91	98	
FOUT, PWMOUT Rise Time	t_{RISE}	See Note 2, $C_L = 15pF$		8.6		ns
FOUT, PWMOUT Fall Time	t_{FALL}	See Note 2, $C_L = 15pF$		7.9		ns
FOUT Jitter		See Note 3		0.08		%
RSET Pin Voltage	$V(RSET)$			0.3		V
CNTRL Output Current	I_{CNTRL}			25	45	nA
		$-40^\circ C \leq T_A \leq 85^\circ C$			100	
PWMOUT Enable	V_{PWM_EN}	$(V_{DD} - V_{CNTRL}), 0.9V < V_{DD} < 1.8V$	375			mV
PWMOUT Disable	V_{PWM_DIS}	$(V_{DD} - V_{CNTRL}), 0.9V < V_{DD} < 1.8V$			131	mV
High Level Output Voltage, FOUT and PWMOUT	$V_{DD} - V_{OH}$	$I_{OH} = 1mA$		160		mV
Low-level Output Voltage, FOUT and PWMOUT	V_{OL}	$I_{OL} = 1mA$		140		mV

- Note 1:** All devices are 100% production tested at $T_A = +25^\circ C$ and are guaranteed by characterization for $T_A = T_{MIN}$ to T_{MAX} , as specified.
- Note 2:** Output rise and fall times are measured between the 10% and 90% of the V_{DD} power-supply voltage levels. The specification is based on lab bench characterization and is not tested in production.
- Note 3:** Timing jitter is the ratio of the peak-to-peak variation of the period to the mean of the period. The specification is based on lab bench characterization and is not tested in production.

TYPICAL PERFORMANCE CHARACTERISTICS

$V_{DD} = 1V$, $V_{CNTRL} = V_{DD}$, $R_{SET} = 4.32M\Omega$, $R_{LOAD(FOUT)} = \text{Open Circuit}$, $C_{LOAD(FOUT)} = 5pF$, unless otherwise noted. Values are at $T_A = 25^\circ C$ unless otherwise noted.

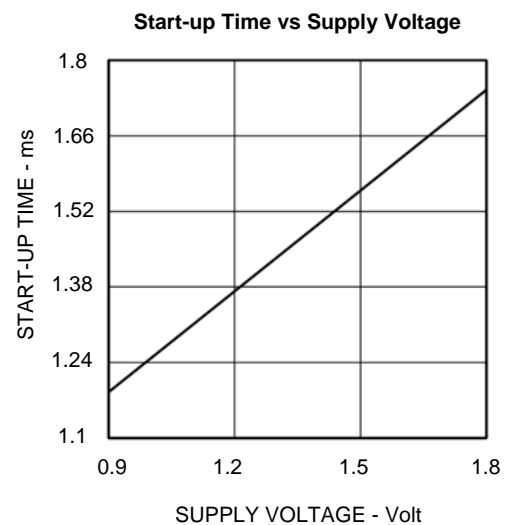
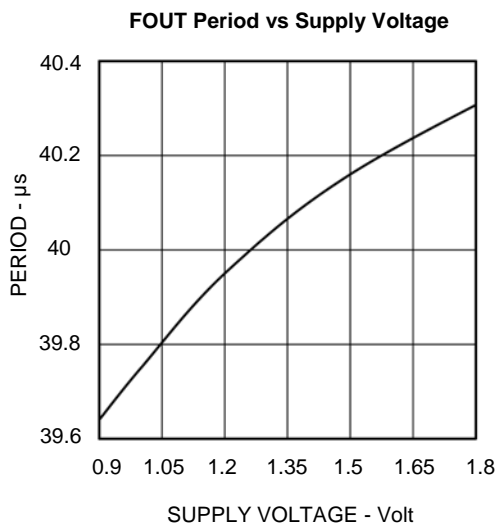
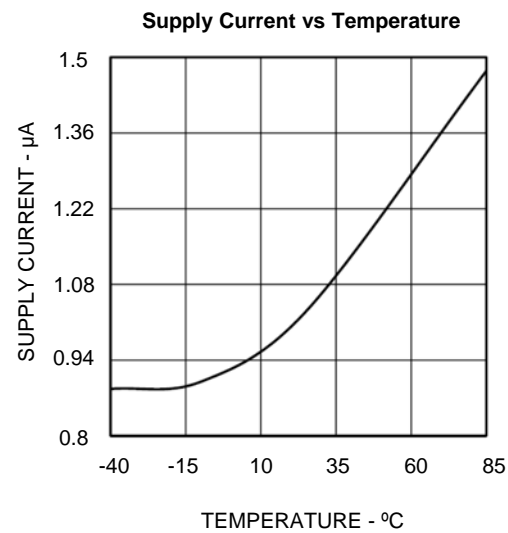
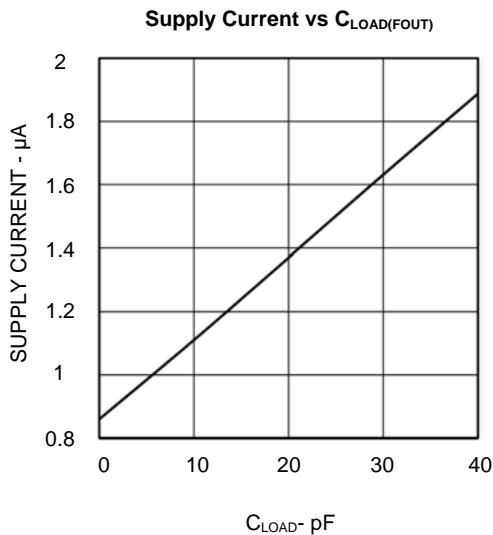
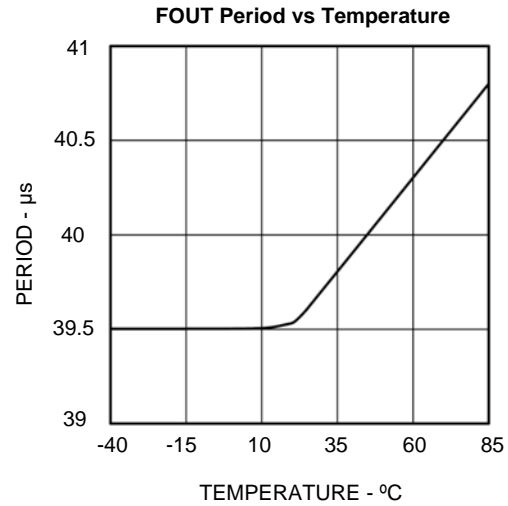
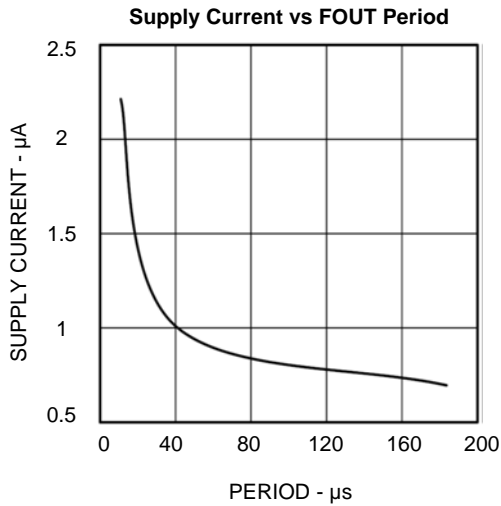



TYPICAL PERFORMANCE CHARACTERISTICS

$V_{DD} = 1V$, $V_{CNTRL} = V_{DD}$, $R_{SET} = 4.32M\Omega$, $R_{LOAD(FOUT)} = \text{Open Circuit}$, $C_{LOAD(FOUT)} = 5pF$, unless otherwise noted. Values are at $T_A = 25^\circ C$ unless otherwise noted.

Period vs R_{SET}

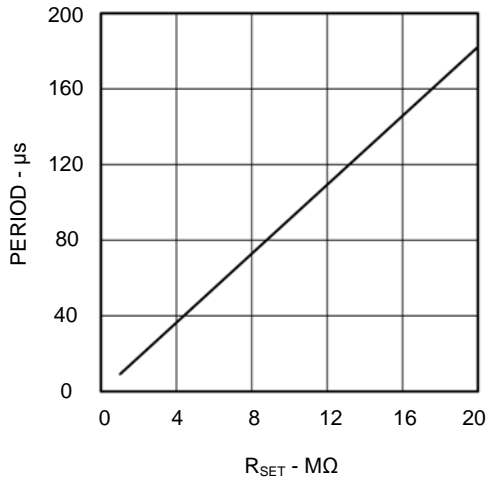

Supply Current Distribution

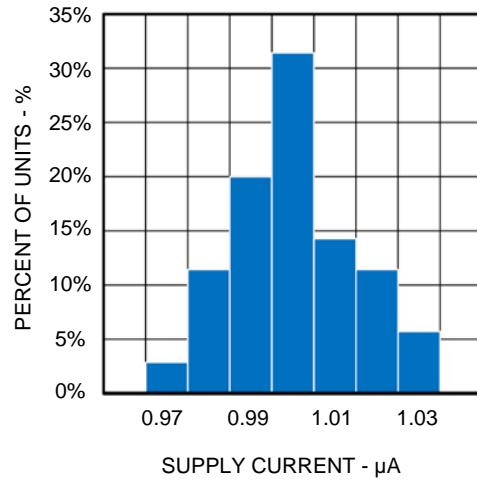

FOUT Transient Response
 $V_{DD} = 1V$, $C_{LOAD} = 47pF$

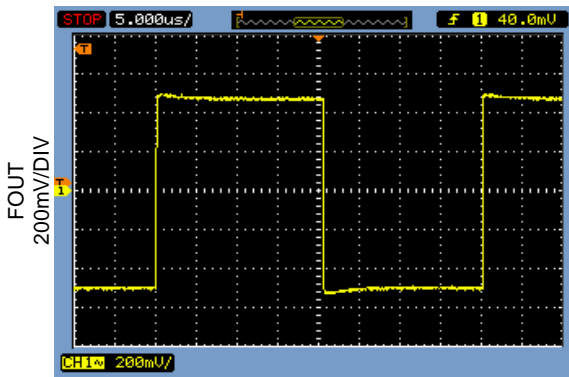

5μs/DIV

FOUT Transient Response
 $V_{DD} = 1.5V$, $C_{LOAD} = 47pF$

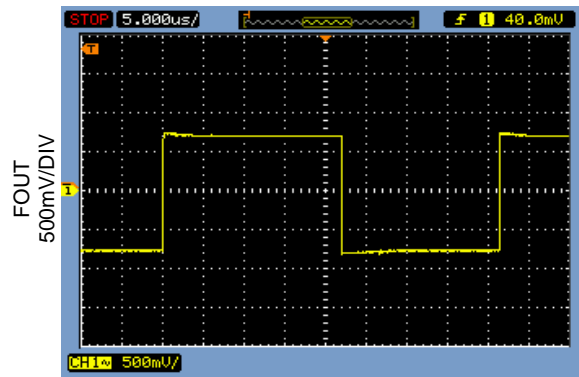

5μs/DIV

FOUT and PWMOUT Transient Response
 $V_{DD} = 1V$, $V_{CNTRL} = 0.035 \times V_{DD}$, $C_{LOAD} = 22pF$

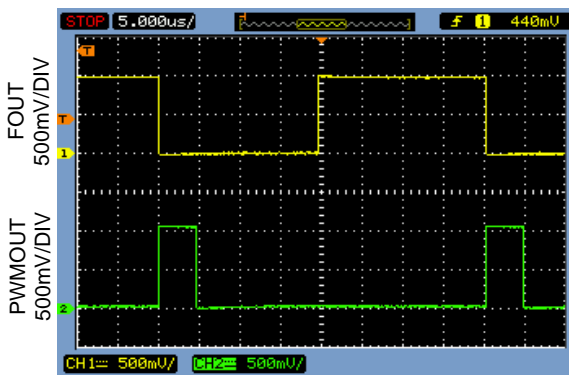

5μs/DIV

FOUT and PWMOUT Transient Response
 $V_{DD} = 1.5V$, $V_{CNTRL} = 0.035 \times V_{DD}$, $C_{LOAD} = 22pF$

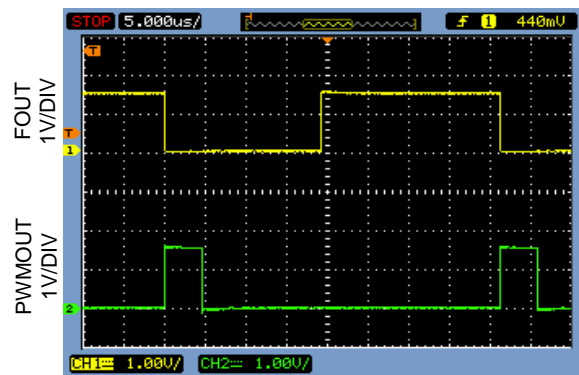

5μs/DIV

PIN FUNCTIONS

PIN	NAME	FUNCTION
1	FOUT	Fixed Duty Cycle Output. A push-pull output stage with an output resistance of 160Ω, the FOUT pin swings from GND to V _{DD} . For lowest power operation, capacitive loads should be minimized and resistive loads should be maximized.
2	NC	No Connection.
3	PWMOUT	Pulse-width Modulated Output. A push-pull output stage with an output resistance of 160Ω, the PWMOUT pin is wired anti-phase with respect to FOUT and swings from GND to V _{DD} . For lowest power operation, capacitive loads should be minimized and resistive loads should be maximized.
4	CNTRL	PWMOUT Enable and Duty Cycle Control Input. An analog input pin, the V _{CNTRL} pin voltage enables the TS3001's PWM engine and controls the duty cycle at PWMOUT from 12% (V _{CNTRL} = 0.03 x V _{DD}) to 90% (V _{CNTRL} = 0.27 x V _{DD}). Enabling the PWM engine increases the TS3001's nominal operating supply current. To disable the TS3001's PWM engine, CNTRL shall be connected to V _{DD} .
5,6	GND	Ground – Connect this pin to the system's analog ground plane.
7	RSET	FOUT Programming Resistor Input. A 4.32MΩ resistor connected from this pin to GND sets the TS3001's internal oscillator's output period to 40μs (25kHz). For optimal performance, the composition of the RSET resistor shall be consistent with tolerances of 1% or lower. The RSET pin voltage is 0.3V at a 1V supply.
8	VDD	Power Supply Voltage Input. While the TS3001 is fully specified at 1V, the supply voltage range is 0.9V ≤ V _{DD} ≤ 1.8V. It is always considered good engineering practice to bypass the V _{DD} pin with a 0.1μF ceramic decoupling capacitor in close proximity to the TS3001.
EP	-----	Exposed paddle is electrically connected to GND.

BLOCK DIAGRAM

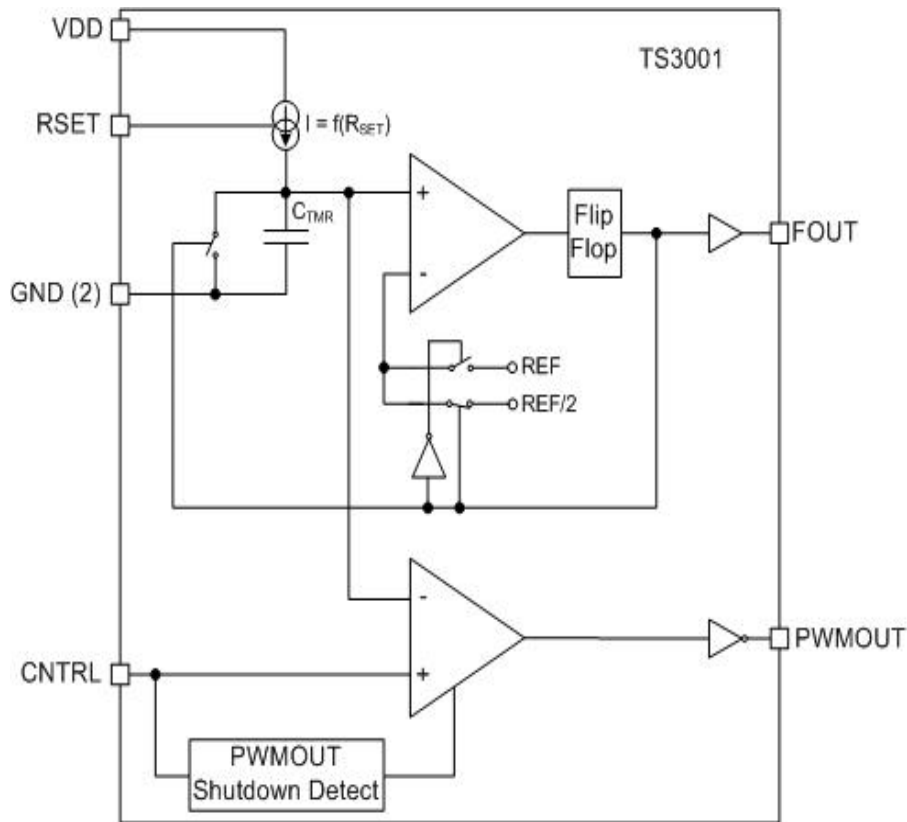

THEORY OF OPERATION

The TS3001 is a user-programmable oscillator where the period of the square wave at its FOUT terminal is generated by an external resistor. The output frequency is given by:

$$F_{OUT} \text{ (kHz)} = \frac{1}{t_{FOUT} \text{ (\mu s)}} = \frac{1E6}{k \times R_{SET} \text{ (M}\Omega\text{)}}$$

Table 1: FOUT vs RSET

R _{SET} (MΩ)	FOUT (kHz)
1	110
2.49	44
4.32	25.5
6.81	16
9.76	11

where the scalar k is approximately 9.09E3. With an R_{SET} = 4.32MΩ, the output frequency is approximately 25kHz with a 50% duty cycle. As design aids, Tables 1 lists TS3001's typical FOUT for various standard values for R_{SET}.

The TS3001 also provides a separate PWM output signal at its PWMOUT terminal that is anti-phase with respect to FOUT. In addition, applying a voltage at the CNTRL both enables the TS3001's internal PWM engine as well as adjusting the duty cycle from 12% to 90%. A dc control voltage equal to 0.03 x VDD applied to the CNTRL pin enables the PWM engine to set the duty cycle to 12%. A dc control voltage equal to 0.27 x VDD increases the duty cycle to 90% and connecting CNTRL to VDD disables the PWM engine altogether. Configured for nominal operation (PWM engine OFF), the supply current of the TS3001 is 1μA; enabling the PWM engine increases the TS3001 operating supply current as shown in the electrical specification table.

APPLICATIONS INFORMATION

Minimizing Power Consumption

To keep the TS3001's power consumption low, resistive loads at the FOUT and PWMOUT terminals increase dc power consumption and therefore should be as large as possible. Capacitive loads at the FOUT and PWMOUT terminals increase the TS3001's transient power consumption and, as well, should be as small as possible.

One challenge to minimizing the TS3001's transient power consumption is the probe capacitance of oscilloscopes and frequency counter instruments. Most instruments exhibit an input capacitance of 15pF or more. Unless buffered, the increase in transient load current can be as much as 400nA.

To minimize capacitive loading, the technique shown in Figure 1 can be used. In this circuit, the principle of series-connected capacitors can be used to reduce the effective capacitive load at the TS3001's FOUT and PWMOUT terminals.

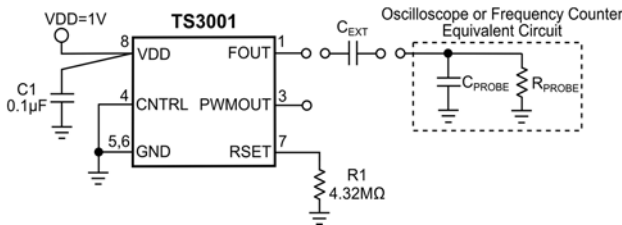

Figure 1: Using an External Capacitor in Series with Probes Reduces Effective Capacitive Load.

To determine the optimal value for C_{EXT} once the probe capacitance is known by simply solving for C_{EXT} using the following expression:

$$C_{EXT} = \frac{1}{\frac{1}{C_{LOAD(EFF)}} - \frac{1}{C_{PROBE}}}$$

For example, if the instrument's input probe capacitance is 15pF and the desired effective load capacitance at either or both FOUT and PWMOUT terminals is to be ≤ 5 pF, then the value of C_{EXT} should be ≤ 7.5 pF.

TS3001 Start-up Time

As the TS3001 is powered up, its FOUT terminal (and PWMOUT terminal, if enabled) is active once the applied VDD is higher than 0.9 volt. Once the applied VDD is higher than 0.9 volt, the master oscillator achieves steady-state operation within 1.2ms.

Current- and Voltage-Controlled Oscillators

The TS3001 can be configured into a Current-Controlled Oscillator as shown in Figure 2.

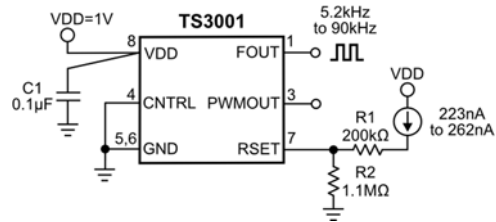

Figure 2: Configuring the TS3001 into a Current-Controlled Oscillator.

With a current source sourcing a current of 223nA to 262nA, FOUT can generate an output signal with a frequency range of 5.2kHz to 90kHz. In a similar manner, a Voltage-Controlled Oscillator can be configured as shown in Figure 3. In this case, a voltage source sourcing a voltage of 290mV to 341mV can generate an FOUT output signal frequency range of 5.2kHz to 90kHz as well. It is recommended to use resistor values with a 1% tolerance.

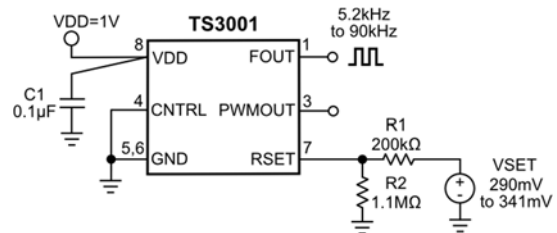

Figure 3: Configuring the TS3001 into a Voltage-Controlled Oscillator.

Using a Potentiometer to Trim the TS3001's Output Frequency

By using a fixed resistor and a potentiometer, the output frequency of the TS3001 can be trimmed as shown in Figure 4. By selecting a fixed resistor R1 with a tolerance of 0.1% and a potentiometer P1 with a 5% tolerance, the output frequency can be trimmed to provide a $\pm 2\%$ trimming range. As shown in Figure 4, R1+P1 set the output frequency to 25.052kHz when P1 = 0 Ω and with P1 = 200k Ω , the resulting output frequency is 24.024kHz.

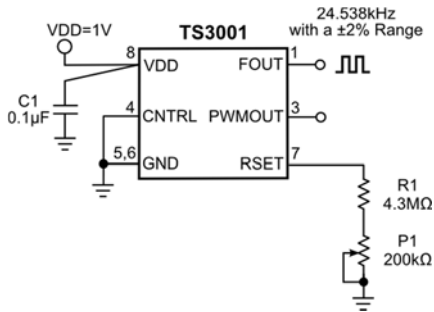

Figure 4: Using a Fixed Resistor and a Potentiometer to Trim the TS3001's Output Frequency.

Using Standard Resistors to Increase FOUT Resolution

The TS3001 can be configured to provide a 0.1% resolution on the output frequency as shown in Figure 5. To do so, R1 can be set to approximately 10% of the value selected for R2. In addition, R2 and R1 should be chosen with a 0.1% and 1% tolerance, respectively. Since R2 is 90% of the total resistance, it has the largest impact on the resolution of the output frequency. With R1 = 91k Ω and R2 = 910k Ω , the output frequency is 90kHz and with R1 = 400k Ω and R2 = 4M Ω , the output frequency is 23kHz.

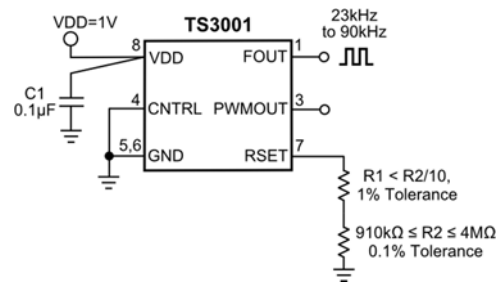
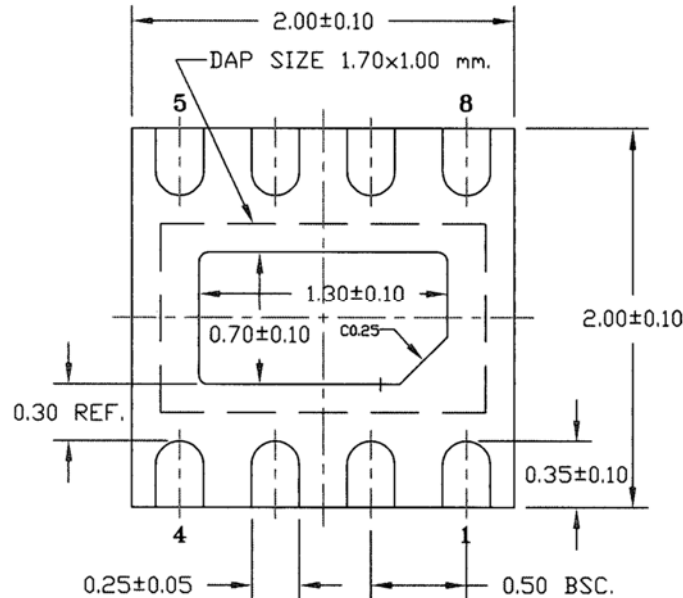

Figure 5: Setting the TS3001's Output Frequency to 0.1% Resolution using Standard Resistors.

PACKAGE OUTLINE DRAWING

8-Pin TDFN22 Package Outline Drawing

(N.B., Drawing not to scale; all dimensions in mm; JEDEC MO-229 compliant)



BOTTOM VIEW

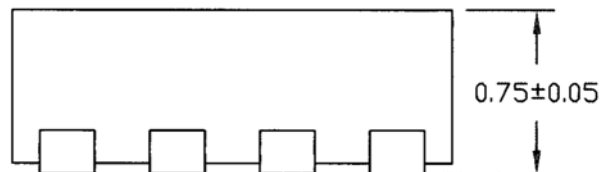

SIDE VIEW

Patent Notice

Silicon Labs invests in research and development to help our customers differentiate in the market with innovative low-power, small size, analog-intensive mixed-signal solutions. Silicon Labs' extensive patent portfolio is a testament to our unique approach and world-class engineering team.

The information in this document is believed to be accurate in all respects at the time of publication but is subject to change without notice. Silicon Laboratories assumes no responsibility for errors and omissions, and disclaims responsibility for any consequences resulting from the use of information included herein. Additionally, Silicon Laboratories assumes no responsibility for the functioning of undescribed features or parameters. Silicon Laboratories reserves the right to make changes without further notice. Silicon Laboratories makes no warranty, representation or guarantee regarding the suitability of its products for any particular purpose, nor does Silicon Laboratories assume any liability arising out of the application or use of any product or circuit, and specifically disclaims any and all liability, including without limitation consequential or incidental damages. Silicon Laboratories products are not designed, intended, or authorized for use in applications intended to support or sustain life, or for any other application in which the failure of the Silicon Laboratories product could create a situation where personal injury or death may occur. Should Buyer purchase or use Silicon Laboratories products for any such unintended or unauthorized application, Buyer shall indemnify and hold Silicon Laboratories harmless against all claims and damages.

Silicon Laboratories and Silicon Labs are trademarks of Silicon Laboratories Inc.
Other products or brandnames mentioned herein are trademarks or registered trademarks of their respective holders.



Smart.
Connected.
Energy-Friendly



Products
www.silabs.com/products



Quality
www.silabs.com/quality



Support and Community
community.silabs.com

Disclaimer

Silicon Laboratories intends to provide customers with the latest, accurate, and in-depth documentation of all peripherals and modules available for system and software implementers using or intending to use the Silicon Laboratories products. Characterization data, available modules and peripherals, memory sizes and memory addresses refer to each specific device, and "Typical" parameters provided can and do vary in different applications. Application examples described herein are for illustrative purposes only. Silicon Laboratories reserves the right to make changes without further notice and limitation to product information, specifications, and descriptions herein, and does not give warranties as to the accuracy or completeness of the included information. Silicon Laboratories shall have no liability for the consequences of use of the information supplied herein. This document does not imply or express copyright licenses granted hereunder to design or fabricate any integrated circuits. The products must not be used within any Life Support System without the specific written consent of Silicon Laboratories. A "Life Support System" is any product or system intended to support or sustain life and/or health, which, if it fails, can be reasonably expected to result in significant personal injury or death. Silicon Laboratories products are generally not intended for military applications. Silicon Laboratories products shall under no circumstances be used in weapons of mass destruction including (but not limited to) nuclear, biological or chemical weapons, or missiles capable of delivering such weapons.

Trademark Information

Silicon Laboratories Inc., Silicon Laboratories, Silicon Labs, SiLabs and the Silicon Labs logo, CMEMS®, EFM, EFM32, EFR, Energy Micro, Energy Micro logo and combinations thereof, "the world's most energy friendly microcontrollers", Ember®, EZLink®, EZMac®, EZRadio®, EZRadioPRO®, DSPLL®, ISOmodem®, Precision32®, ProSLIC®, SiPHY®, USBXpress® and others are trademarks or registered trademarks of Silicon Laboratories Inc. ARM, CORTEX, Cortex-M3 and THUMB are trademarks or registered trademarks of ARM Holdings. Keil is a registered trademark of ARM Limited. All other products or brand names mentioned herein are trademarks of their respective holders.



Silicon Laboratories Inc.
400 West Cesar Chavez
Austin, TX 78701
USA

<http://www.silabs.com>