

## 阅读申明

- 1.本站收集的数据手册和产品资料都来自互联网，版权归原作者所有。如读者和版权方有任何异议请及时告之，我们将妥善解决。
- 2.本站提供的中文数据手册是英文数据手册的中文翻译，其目的是协助用户阅读，该译文无法自动跟随原稿更新，同时也可能存在翻译上的不当。建议读者以英文原稿为参考以便获得更精准的信息。
- 3.本站提供的产品资料，来自厂商的技术支持或者使用者的心得体会等，其内容可能存在描述上的差异，建议读者做出适当判断。
- 4.如需与我们联系，请发邮件到marketing@iczoom.com，主题请标有“数据手册”字样。

## Read Statement

1. The datasheets and other product information on the site are all from network reference or other public materials, and the copyright belongs to the original author and original published source. If readers and copyright owners have any objections, please contact us and we will deal with it in a timely manner.
2. The Chinese datasheets provided on the website is a Chinese translation of the English datasheets. Its purpose is for reader's learning exchange only and do not involve commercial purposes. The translation cannot be automatically updated with the original manuscript, and there may also be improper translations. Readers are advised to use the English manuscript as a reference for more accurate information.
3. All product information provided on the website refer to solutions from manufacturers' technical support or users the contents may have differences in description, and readers are advised to take the original article as the standard.
4. If you have any questions, please contact us at marketing@iczoom.com and mark the subject with "Datasheets" .



## DS1248/DS1248P 1024K NV SRAM with Phantom Clock

### FEATURES

- Real-Time Clock (RTC) Keeps Track of Hundredths of Seconds, Minutes, Hours, Days, Date of the Month, Months, and Years
- 128K x 8 NV SRAM Directly Replaces Volatile Static RAM or EEPROM
- Embedded Lithium Energy Cell Maintains Calendar Operation and Retains RAM Data
- Watch Function is Transparent to RAM Operation
- Automatic Leap Year Compensation Valid Up to 2100
- Full 10% Operating Range
- Over 10 Years of Data Retention in the Absence of Power
- Lithium Energy Source is Electrically Disconnected to Retain Freshness Until Power is Applied for the First Time
- DIP Module Only  
Standard 32-Pin JEDEC Pinout
- Underwriters Laboratories (UL) Recognized ([www.maxim-ic.com/qa/info/ul/](http://www.maxim-ic.com/qa/info/ul/))
- PowerCap Module Board Only  
Surface Mountable Package for Direct Connection to PowerCap Containing Battery and Crystal  
Replaceable Battery (PowerCap)  
Pin-for-Pin Compatible with DS1244P and DS1251P

### PIN CONFIGURATIONS

TOP VIEW

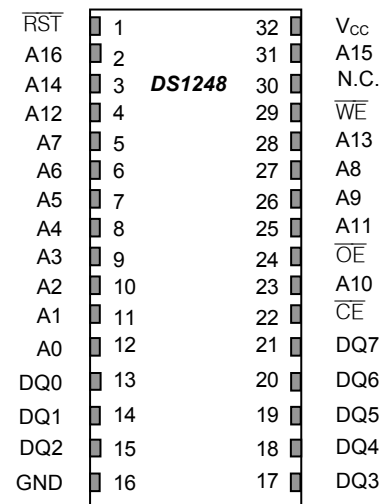

**Encapsulated DIP  
(740-mil Flush)**

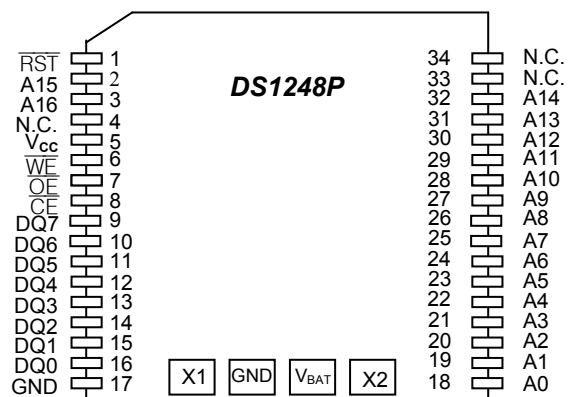

**PowerCap Module Board  
(Uses DS9034PCX+ PowerCap)**

## ORDERING INFORMATION

PART	TEMP RANGE	V <sub>CC</sub> RANGE	PIN-PACKAGE
DS1248Y-70+	0°C to +70°C	5V ±10%	32 EDIP
DS1248Y-70IND+	-40°C to +85°C	5V ±10%	32 EDIP
DS1248YP-70+	0°C to +70°C	5V ±10%	34 PowerCap*
DS1248W-120+	0°C to +70°C	3.3V ±10%	32 EDIP
DS1248W-120IND+	-40°C to +85°C	3.3V ±10%	32 EDIP
DS1248WP-120+	0°C to +70°C	3.3V ±10%	34 PowerCap*
DS1248WP-120IND+	-40°C to +85°C	3.3V ±10%	34 PowerCap*

+ Denotes a lead(Pb)-free/RoHS-compliant package.

\* DS9034PCX+ or DS9034I-PCX+ (PowerCap) required. Must be ordered separately.

## DETAILED DESCRIPTION

The DS1248 1024K NV SRAM with phantom clock is a fully static, nonvolatile RAM (organized as 128K words by 8 bits) with a built-in real-time clock. The DS1248 has a self-contained lithium energy source and control circuitry, which constantly monitors V<sub>CC</sub> for an out-of-tolerance condition. When such a condition occurs, the lithium energy source is automatically switched on and writes protection is unconditionally enabled to prevent garbled data in both the memory and real-time clock.

## PACKAGES

The DS1248 is available in two packages: 32-pin DIP and 34-pin PowerCap module. The 32-pin DIP style module integrates the crystal, lithium energy source, and silicon in one package. The 34-pin PowerCap module board is designed with contacts for connection to a separate PowerCap (DS9034PCX) that contains the crystal and battery. This design allows the PowerCap to be mounted on top of the DS1248P after completion of the surface mount process. Mounting the PowerCap after the surface mount process prevents damage to the crystal and battery because of the high temperatures required for solder reflow. The PowerCap is keyed to prevent reverse insertion. The PowerCap module board and PowerCap are ordered separately and shipped in separate containers.

**PIN DESCRIPTION**

PIN		NAME	FUNCTION
EDIP	PowerCap		
1	1	$\overline{\text{RST}}$	Active-Low Reset Input. This pin has an internal pullup resistor connected to $V_{CC}$ .
2	3	A16	Address Inputs
3	32	A14	
4	30	A12	
5	25	A7	
6	24	A6	
7	23	A5	
8	22	A4	
9	21	A3	
10	20	A2	
11	19	A1	
12	18	A0	
23	28	A10	
25	29	A11	
26	27	A9	
27	26	A8	
28	31	A13	
31	2	A15	
13	16	DQ0	Data In/Data Out
14	15	DQ1	
15	14	DQ2	
17	13	DQ3	
18	12	DQ4	
19	11	DQ5	
20	10	DQ6	
21	9	DQ7	
22	8	$\overline{\text{CE}}$	Active-Low Chip-Enable Input
24	7	$\overline{\text{OE}}$	Active-Low Output-Enable Input
29	6	$\overline{\text{WE}}$	Active-Low Write-Enable Input
30	4, 33, 34	N.C.	No Connect
32	5	$V_{CC}$	Power-Supply Input
16	17	GND	Ground

## RAM READ MODE

The DS1248 executes a read cycle whenever  $\overline{WE}$  (write enable) is inactive (high) and  $\overline{CE}$  (chip enable) is active (low). The unique address specified by the 17 address inputs (A0–A16) defines which of the 128k bytes of data is to be accessed. Valid data will be available to the eight data-output drivers within  $t_{ACC}$  (access time) after the last address input signal is stable, providing that  $\overline{CE}$  and  $\overline{OE}$  (output enable) access times and states are also satisfied. If  $\overline{OE}$  and  $\overline{CE}$  access times are not satisfied, then data access must be measured from the later occurring signal ( $\overline{CE}$  or  $\overline{OE}$ ) and the limiting parameter is either  $t_{CO}$  for  $\overline{CE}$  or  $t_{OE}$  for  $\overline{OE}$ , rather than address access.

## RAM WRITE MODE

The DS1248 is in the write mode whenever the  $\overline{WE}$  and  $\overline{CE}$  signals are in the active (low) state after address inputs are stable. The latter occurring falling edge of  $\overline{CE}$  or  $\overline{WE}$  will determine the start of the write cycle. The write cycle is terminated by the earlier rising edge of  $\overline{CE}$  or  $\overline{WE}$ . All address inputs must be kept valid throughout the write cycle.  $\overline{WE}$  must return to the high state for a minimum recovery time ( $t_{WR}$ ) before another cycle can be initiated. The  $\overline{OE}$  control signal should be kept inactive (high) during write cycles to avoid bus contention. However, if the output bus has been enabled ( $\overline{CE}$  and  $\overline{OE}$  active) then  $\overline{WE}$  will disable the outputs in  $t_{ODW}$  from its falling edge.

## DATA RETENTION MODE

The 5V device is fully accessible and data can be written or read only when  $V_{CC}$  is greater than  $V_{PF}$ . However, when  $V_{CC}$  is below the power-fail point,  $V_{PF}$  (point at which write protection occurs), the internal clock registers and SRAM are blocked from any access. When  $V_{CC}$  falls below the battery switch point,  $V_{SO}$  (battery supply level), device power is switched from the  $V_{CC}$  pin to the backup battery. RTC operation and SRAM data are maintained from the battery until  $V_{CC}$  is returned to nominal levels.

The 3.3V device is fully accessible and data can be written or read only when  $V_{CC}$  is greater than  $V_{PF}$ . When  $V_{CC}$  falls below  $V_{PF}$ , access to the device is inhibited. If  $V_{PF}$  is less than  $V_{BAT}$ , the device power is switched from  $V_{CC}$  to the backup supply ( $V_{BAT}$ ) when  $V_{CC}$  drops below  $V_{PF}$ . If  $V_{PF}$  is greater than  $V_{BAT}$ , the device power is switched from  $V_{CC}$  to the backup supply ( $V_{BAT}$ ) when  $V_{CC}$  drops below  $V_{BAT}$ . RTC operation and SRAM data are maintained from the battery until  $V_{CC}$  is returned to nominal levels.

All control, data, and address signals must be powered down when  $V_{CC}$  is powered-down.

## PHANTOM CLOCK OPERATION

Communication with the phantom clock is established by pattern recognition on a serial bit stream of 64 bits, which must be matched by executing 64 consecutive write cycles containing the proper data on DQ0. All accesses that occur prior to recognition of the 64-bit pattern are directed to memory.

After recognition is established, the next 64 read or write cycles either extract or update data in the phantom clock, and memory access is inhibited.

Data transfer to and from the timekeeping function is accomplished with a serial bit stream under control of chip enable, output enable, and write enable. Initially, a read cycle to any memory location using the  $\overline{\text{CE}}$  and  $\overline{\text{OE}}$  control of the phantom clock starts the pattern recognition sequence by moving a pointer to the first bit of the 64-bit comparison register. Next, 64 consecutive write cycles are executed using the  $\overline{\text{CE}}$  and  $\overline{\text{WE}}$  control of the SmartWatch. These 64 write cycles are used only to gain access to the phantom clock. Therefore, any address to the memory in the socket is acceptable. However, the write cycles generated to gain access to the phantom clock are also writing data to a location in the mated RAM. The preferred way to manage this requirement is to set aside just one address location in RAM as a phantom clock scratch pad. When the first write cycle is executed, it is compared to bit 0 of the 64-bit comparison register. If a match is found, the pointer increments to the next location of the comparison register and awaits the next write cycle. If a match is not found, the pointer does not advance and all subsequent write cycles are ignored. If a read cycle occurs at any time during pattern recognition, the present sequence is aborted and the comparison register pointer is reset. Pattern recognition continues for a total of 64 write cycles as described above until all the bits in the comparison register have been matched (Figure 1). With a correct match for 64 bits, the phantom clock is enabled and data transfer to or from the timekeeping registers can proceed. The next 64 cycles will cause the phantom clock to either receive or transmit data on DQ0, depending on the level of the  $\overline{\text{OE}}$  pin or the  $\overline{\text{WE}}$  pin. Cycles to other locations outside the memory block can be interleaved with  $\overline{\text{CE}}$  cycles without interrupting the pattern recognition sequence or data transfer sequence to the phantom clock.

## PHANTOM CLOCK REGISTER INFORMATION

The phantom clock information is contained in eight registers of 8 bits, each of which is sequentially accessed 1 bit at a time after the 64-bit pattern recognition sequence has been completed. When updating the phantom clock registers, each register must be handled in groups of 8 bits. Writing and reading individual bits within a register could produce erroneous results. These read/write registers are defined in Figure 2.

Data contained in the phantom clock register is in binary-coded decimal format (BCD). Reading and writing the registers is always accomplished by stepping through all eight registers, starting with bit 0 of register 0 and ending with bit 7 of register 7.

**Figure 1. Phantom Clock Register Definition**

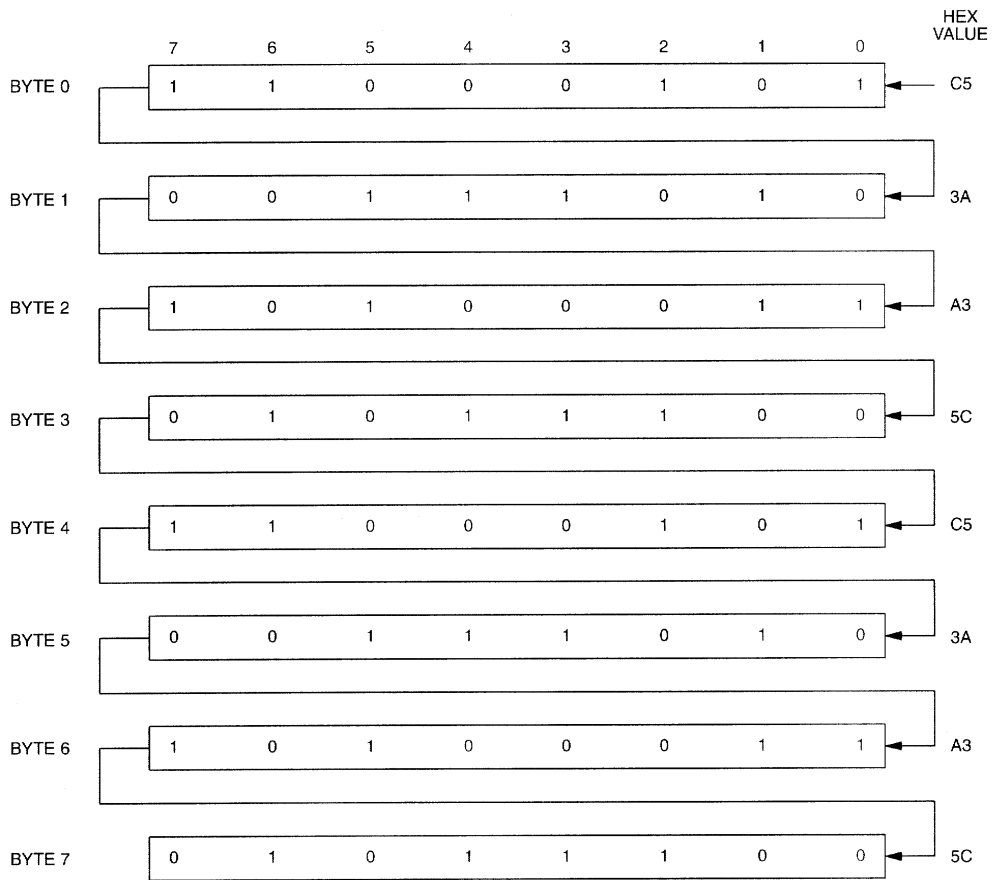

**NOTE:** THE PATTERN RECOGNITION IN HEX IS C5, 3A, A3, 5C, C5, 3A, A3, 5C. THE ODDS OF THIS PATTERN BEING ACCIDENTALLY DUPLICATED AND CAUSING INADVERTENT ENTRY TO THE PHANTOM CLOCK IS LESS THAN 1 IN 10<sup>19</sup>. THIS PATTERN IS SENT TO THE PHANTOM CLOCK LSB TO MSB.

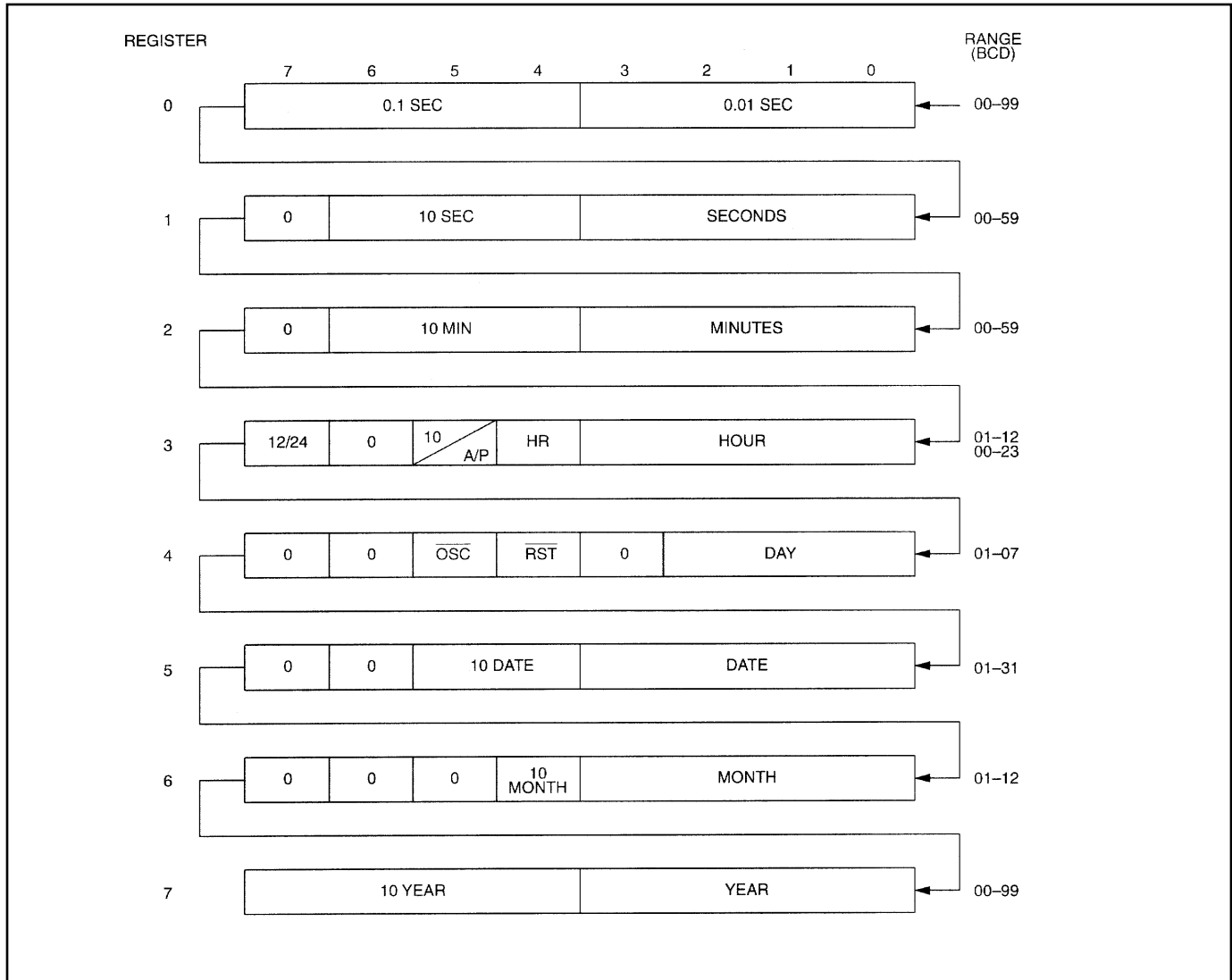
**Figure 2. Phantom Clock Register Definition**

### AM/PM/12/24-MODE

Bit 7 of the hours register is defined as the 12-hour or 24-hour mode-select bit. When high, the 12-hour mode is selected. In the 12-hour mode, bit 5 is the AM/PM bit with logic high being PM. In the 24-hour mode, bit 5 is the 20-hour bit (20–23 hours).

### OSCILLATOR AND RESET BITS

Bits 4 and 5 of the day register are used to control the  $\overline{\text{RST}}$  and oscillator functions. Bit 4 controls the  $\overline{\text{RST}}$  (pin 1). When the  $\overline{\text{RST}}$  bit is set to logic 1, the  $\overline{\text{RST}}$  input pin is ignored. When the  $\overline{\text{RST}}$  bit is set to logic 0, a low input on the  $\overline{\text{RST}}$  pin will cause the phantom clock to abort data transfer without changing data in the watch registers. Bit 5 controls the oscillator. When set to logic 1, the oscillator is off. When set to logic 0, the oscillator turns on and the watch becomes operational. These bits are shipped from the factory set to a logic 1.



## **ZERO BITS**

Registers 1, 2, 3, 4, 5, and 6 contain one or more bits, which will always read logic 0. When writing these locations, either a logic 1 or 0 is acceptable.

## **BATTERY LONGEVITY**

The DS1248 has a lithium power source that is designed to provide energy for clock activity and clock and RAM data retention when the  $V_{CC}$  supply is not present. The capability of this internal power supply is sufficient to power the DS1248 continuously for the life of the equipment in which it is installed. For specification purposes, the life expectancy is 10 years at +25°C with the internal clock oscillator running in the absence of  $V_{CC}$  power. Each DS1248 is shipped from Maxim with its lithium energy source disconnected, guaranteeing full energy capacity. When  $V_{CC}$  is first applied at a level greater than  $V_{PF}$ , the lithium energy source is enabled for battery-backup operation. Actual life expectancy of the DS1248 will be much longer than 10 years since no lithium battery energy is consumed when  $V_{CC}$  is present.

See “Conditions of Acceptability” at [www.maxim-ic.com/TechSupport/QA/ntrl.htm](http://www.maxim-ic.com/TechSupport/QA/ntrl.htm)

## **CLOCK ACCURACY (DIP MODULE)**

The DS1248 is guaranteed to keep time accuracy to within  $\pm 1$  minute per month at +25°C. The clock is calibrated at the factory by Maxim using special calibration nonvolatile tuning elements and does not require additional calibration. For this reason, methods of field clock calibration are not available and not necessary.

## **CLOCK ACCURACY (POWERCAP MODULE)**

The DS1248P and DS9034PCX are each individually tested for accuracy. Once mounted together, the module will typically keep time accuracy to within  $\pm 1.53$  minutes per month (35ppm) at +25°C.

**ABSOLUTE MAXIMUM RATINGS**

Voltage Range on Any Pin Relative to Ground	(5V product).....	-0.3V to +6.0V
	(3.3V product).....	-0.3V to +4.6V
Storage Temperature Range		
EDIP .....		-40°C to +85°C
PowerCap .....		-55°C to +125°C
Lead Temperature (soldering, 10s) .....		+260°C
<b>Note:</b> EDIP is wave or hand-soldered only.		
Soldering Temperature (reflow, PowerCap) .....		+260°C

*This is a stress rating only and functional operation of the device at these or any other conditions beyond those indicated in the operation sections of this specification is not implied. Exposure to absolute maximum rating conditions for extended periods of time can affect reliability.*

**OPERATING RANGE**

RANGE	TEMP RANGE (NONCONDENSING)	V <sub>CC</sub> (V)
Commercial	0°C to +70°C	3.3 ±10% or 5 ±10%
Industrial	-40°C to +85°C	3.3 ±10% or 5 ±10%

**RECOMMENDED OPERATING CONDITIONS**

Over the Operating Range

PARAMETER		SYMBOL	MIN	TYP	MAX	UNITS	NOTES
Logic 1	V <sub>CC</sub> = 5V ±10%	V <sub>IH</sub>	2.2		V <sub>CC</sub> + 0.3	V	11
	V <sub>CC</sub> = 3.3V ±10%		2.0		V <sub>CC</sub> + 0.3		
Logic 0	V <sub>CC</sub> = 5V ±10%	V <sub>IL</sub>	-0.3		+0.8	V	11
	V <sub>CC</sub> = 3.3V ±10%		-0.3		+0.6		

**DC ELECTRICAL CHARACTERISTICS**

Over the Operating Range (5V)

PARAMETER	SYMBOL	MIN	TYP	MAX	UNITS	NOTES
Input Leakage Current	I <sub>IL</sub>	-1.0		+1.0	μA	12
I/O Leakage Current CE ≥ V <sub>IH</sub> ≤ V <sub>CC</sub>	I <sub>IO</sub>	-1.0		+1.0	μA	
Output Current at 2.4V	I <sub>OH</sub>	-1.0			mA	
Output Current at 0.4V	I <sub>OL</sub>	2.0			mA	
Standby Current CE = 2.2V	I <sub>CCS1</sub>		5	10	mA	
Standby Current CE = V <sub>CC</sub> - 0.5V	I <sub>CCS2</sub>		3.0	5.0	mA	
Operating Current t <sub>CYC</sub> = 70ns	I <sub>CC01</sub>			85	mA	
Write Protection Voltage	V <sub>PF</sub>	4.25	4.37	4.50	V	11
Battery Switchover Voltage	V <sub>SO</sub>		V <sub>BAT</sub>		V	11

**DC ELECTRICAL CHARACTERISTICS**

Over the Operating Range (3.3V)

PARAMETER	SYMBOL	MIN	TYP	MAX	UNITS	NOTES
Input Leakage Current	$I_{IL}$	-1.0		+1.0	$\mu\text{A}$	12
I/O Leakage Current $\overline{\text{CE}} \geq V_{IH} \leq V_{CC}$	$I_{IO}$	-1.0		+1.0	$\mu\text{A}$	
Output Current at 2.4V	$I_{OH}$	-1.0			mA	
Output Current at 0.4V	$I_{OL}$	2.0			mA	
Standby Current $\overline{\text{CE}} = 2.2\text{V}$	$I_{CCS1}$		5	7	mA	
Standby Current $\overline{\text{CE}} = V_{CC} - 0.5\text{V}$	$I_{CCS2}$		2.0	3.0	mA	
Operating Current $t_{CYC} = 70\text{ns}$	$I_{CC01}$			50	mA	
Write Protection Voltage	$V_{PF}$	2.80	2.86	2.97	V	11
Battery Switchover Voltage	$V_{SO}$		$V_{BAT}$ OR $V_{PF}$		V	11

**CAPACITANCE** $(T_A = +25^\circ\text{C})$ 

PARAMETER	SYMBOL	MIN	TYP	MAX	UNITS	NOTES
Input Capacitance	$C_{IN}$		5	10	pF	
Input/Output Capacitance	$C_{I/O}$		5	10	pF	

**MEMORY AC ELECTRICAL CHARACTERISTICS**

Over the Operating Range (5V)

PARAMETER	SYMBOL	DS1248Y-70		UNITS	NOTES
		MIN	MAX		
Read Cycle Time	$t_{RC}$	70		ns	
Access Time	$t_{ACC}$		70	ns	
$\overline{\text{OE}}$ to Output Valid	$t_{OE}$		35	ns	
$\overline{\text{CE}}$ to Output Valid	$t_{CO}$		70	ns	
$\overline{\text{OE}}$ or $\overline{\text{CE}}$ to Output Active	$t_{COE}$	5		ns	5
Output High-Z from Deselection	$t_{OD}$		25	ns	5
Output Hold from Address Change	$t_{OH}$	5		ns	
Write Cycle Time	$t_{WC}$	70		ns	
Write Pulse Width	$t_{WP}$	50		ns	3
Address Setup Time	$t_{AW}$	0		ns	
Write Recovery Time	$t_{WR}$	0		ns	
Output High-Z from $\overline{\text{WE}}$	$t_{ODW}$		25	ns	5
Output Active from $\overline{\text{WE}}$	$t_{OEWE}$	5		ns	5
Data Setup Time	$t_{DS}$	30		ns	4
Data Hold Time from $\overline{\text{WE}}$	$t_{DH}$	5		ns	4

**PHANTOM CLOCK AC ELECTRICAL CHARACTERISTICS**

Over the Operating Range (5V)

PARAMETER	SYMBOL	MIN	TYP	MAX	UNITS	NOTES
Read Cycle Time	$t_{RC}$	65			ns	
$\overline{CE}$ Access Time	$t_{CO}$			55	ns	
$\overline{OE}$ Access Time	$t_{OE}$			55	ns	
$\overline{CE}$ to Output Low-Z	$t_{COE}$	5			ns	
$\overline{OE}$ to Output Low-Z	$t_{OEE}$	5			ns	
$\overline{CE}$ to Output High-Z	$t_{OD}$			25	ns	5
$\overline{OE}$ to Output High-Z	$t_{ODO}$			25	ns	5
Read Recovery	$t_{RR}$	10			ns	
Write Cycle Time	$t_{WC}$	65			ns	
Write Pulse Width	$t_{WP}$	55			ns	3
Write Recovery	$t_{WR}$	10			ns	10
Data Setup Time	$t_{DS}$	30			ns	4
Data Hold Time	$t_{DH}$	0			ns	4
$\overline{CE}$ Pulse Width	$t_{CW}$	60			ns	
RST Pulse Width	$t_{RST}$	65			ns	

**POWER-DOWN/POWER-UP TIMING**

Over the Operating Range (3.3V)

PARAMETER	SYMBOL	MIN	TYP	MAX	UNITS	NOTES
$\overline{CE}$ at $V_{IH}$ before Power-Down	$t_{PD}$	0			$\mu$ s	
$V_{CC}$ Slew from $V_{PF(max)}$ to $V_{PF(min)}$ ( $\overline{CE}$ at $V_{PF}$ )	$t_F$	300			$\mu$ s	
$V_{CC}$ Slew from $V_{PF(min)}$ to $V_{SO}$	$t_{FB}$	10			$\mu$ s	
$V_{CC}$ Slew from $V_{PF(max)}$ to $V_{PF(min)}$ ( $\overline{CE}$ at $V_{PF}$ )	$t_R$	0			$\mu$ s	
$\overline{CE}$ at $V_{IH}$ after Power-Up	$t_{REC}$	1.5		2.5	ms	

(T<sub>A</sub> = +25°C)

PARAMETER	SYMBOL	MIN	TYP	MAX	UNITS	NOTES
Expected Data-Retention Time	$t_{DR}$	10			years	9

**Warning:** Under no circumstances are negative undershoots of any amplitude allowed when device is in battery-backup mode.

**MEMORY AC ELECTRICAL CHARACTERISTICS**

Over the Operating Range (3.3V)

PARAMETER	SYMBOL	DS1248W-120		UNITS	NOTES
		MIN	MAX		
Read Cycle Time	$t_{RC}$	120		ns	
Access Time	$t_{ACC}$		120	ns	
$\overline{OE}$ to Output Valid	$t_{OE}$		60	ns	
$\overline{CE}$ to Output Valid	$t_{CO}$		120	ns	
$\overline{OE}$ or $\overline{CE}$ to Output Active	$t_{COE}$	5		ns	5
Output High-Z from Deselection	$t_{OD}$		40	ns	5
Output Hold from Address Change	$t_{OH}$	5		ns	
Write Cycle Time	$t_{WC}$	120		ns	
Write Pulse Width	$t_{WP}$	90		ns	3
Address Setup Time	$t_{AW}$	0		ns	
Write Recovery Time	$t_{WR}$	20		ns	10
Output High-Z from $\overline{WE}$	$t_{ODW}$		40	ns	5
Output Active from $\overline{WE}$	$t_{OEW}$	5		ns	5
Data Setup Time	$t_{DS}$	50		ns	4
Data Hold Time from $\overline{WE}$	$t_{DH}$	20		ns	4

**PHANTOM CLOCK AC ELECTRICAL CHARACTERISTICS**

Over the Operating Range (3.3V)

PARAMETER	SYMBOL	MIN	TYP	MAX	UNITS	NOTES
Read Cycle Time	$t_{RC}$	120			ns	
$\overline{CE}$ Access Time	$t_{CO}$			100	ns	
$\overline{OE}$ Access Time	$t_{OE}$			100	ns	
$\overline{CE}$ to Output Low-Z	$t_{COE}$	5			ns	
$\overline{OE}$ to Output Low-Z	$t_{OEE}$	5			ns	
$\overline{CE}$ to Output High-Z	$t_{OD}$			40	ns	5
$\overline{OE}$ to Output High-Z	$t_{ODO}$			40	ns	5
Read Recovery	$t_{RR}$	20			ns	
Write Cycle Time	$t_{WC}$	120			ns	
Write Pulse Width	$t_{WP}$	100			ns	3
Write Recovery	$t_{WR}$	20			ns	10
Data Setup Time	$t_{DS}$	45			ns	4
Data Hold Time	$t_{DH}$	0			ns	4
$\overline{CE}$ Pulse Width	$t_{CW}$	105			ns	
$\overline{RST}$ Pulse Width	$t_{RST}$	120			ns	

## POWER-DOWN/POWER-UP TIMING

Over the Operating Range (3.3V)

PARAMETER	SYMBOL	MIN	TYP	MAX	UNITS	NOTES
$\overline{CE}$ at $V_{IH}$ before Power-Down	$t_{PD}$	0			$\mu s$	
$V_{CC}$ Slew from $V_{PF(MAX)}$ to $V_{PF(MIN)}$ ( $\overline{CE}$ at $V_{IH}$ )	$t_F$	300			$\mu s$	
$V_{CC}$ Slew from $V_{PF(MAX)}$ to $V_{PF(MIN)}$ ( $\overline{CE}$ at $V_{IH}$ )	$t_R$	0			$\mu s$	
$\overline{CE}$ at $V_{IH}$ after Power-Up	$t_{REC}$	1.5		2.5	ms	

( $T_A = +25^\circ C$ )

PARAMETER	SYMBOL	MIN	TYP	MAX	UNITS	NOTES
Expected Data-Retention Time	$t_{DR}$	10			years	9

**Warning:** Under no circumstances are negative undershoots, of any amplitude, allowed when device is in battery-backup mode.

## MEMORY READ CYCLE (Note 1)

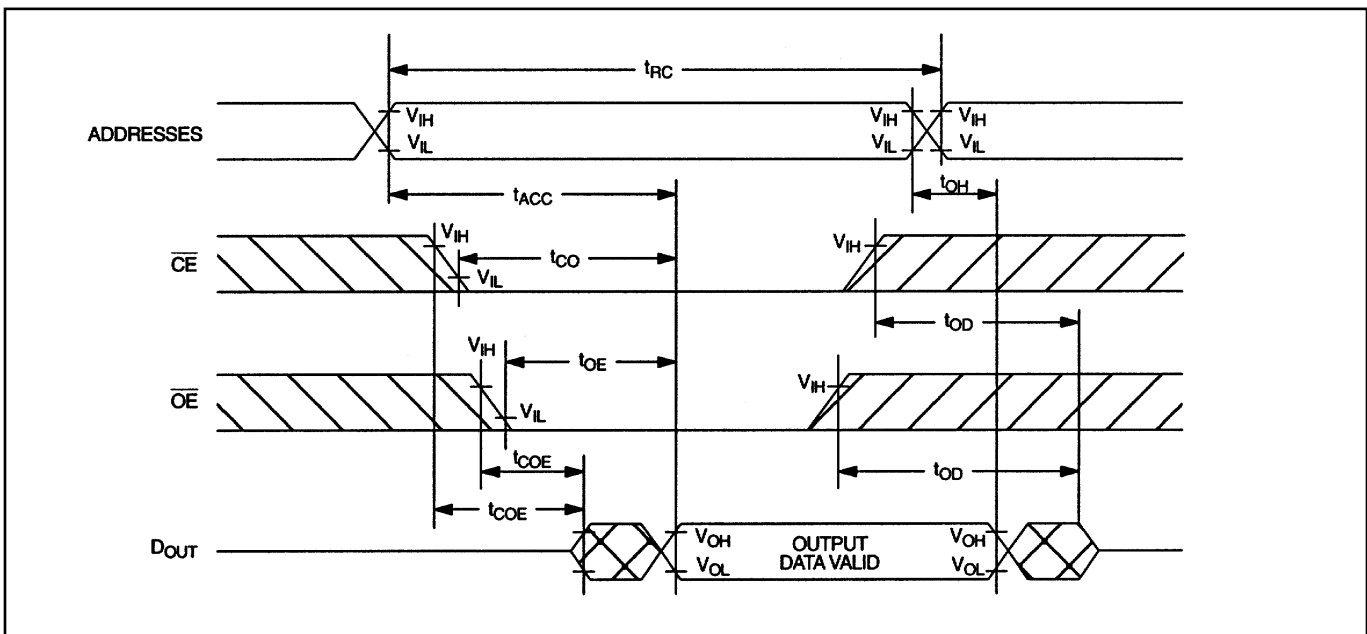

### MEMORY WRITE CYCLE 1 (Notes 2, 6, and 7)

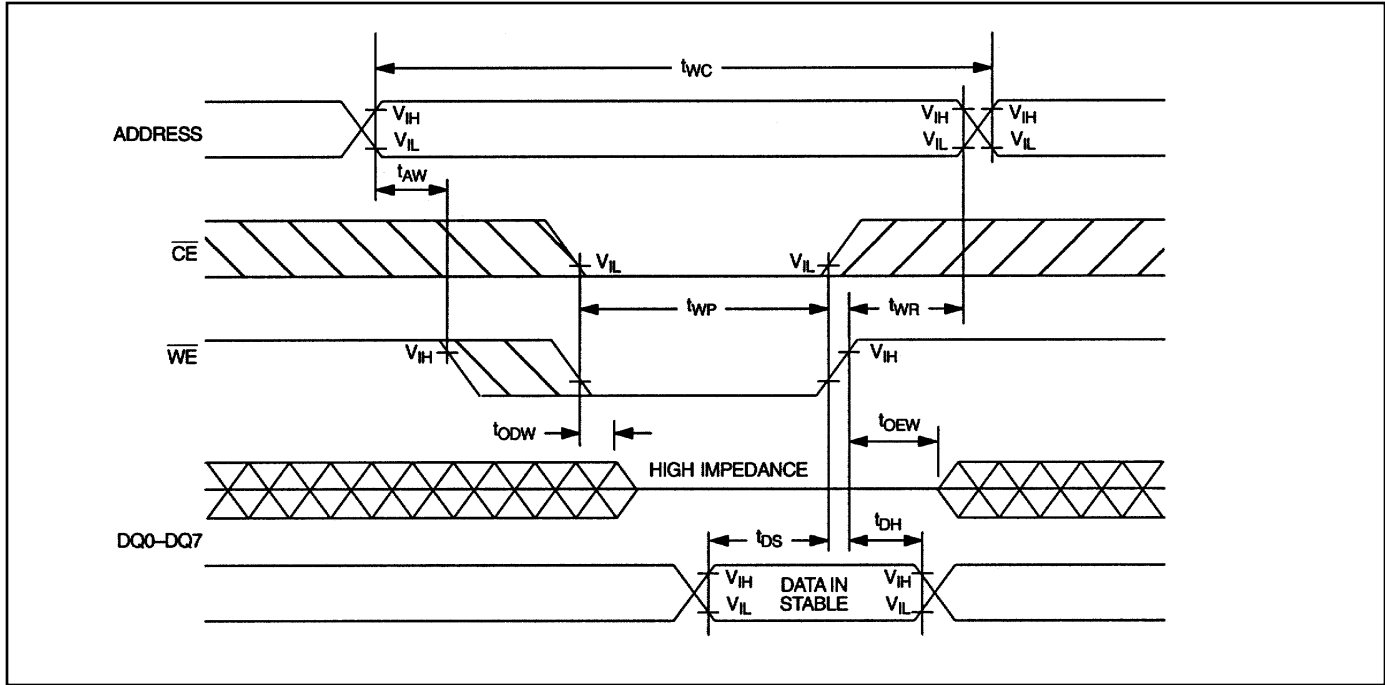

### MEMORY WRITE CYCLE 2 (Notes 2 and 8)

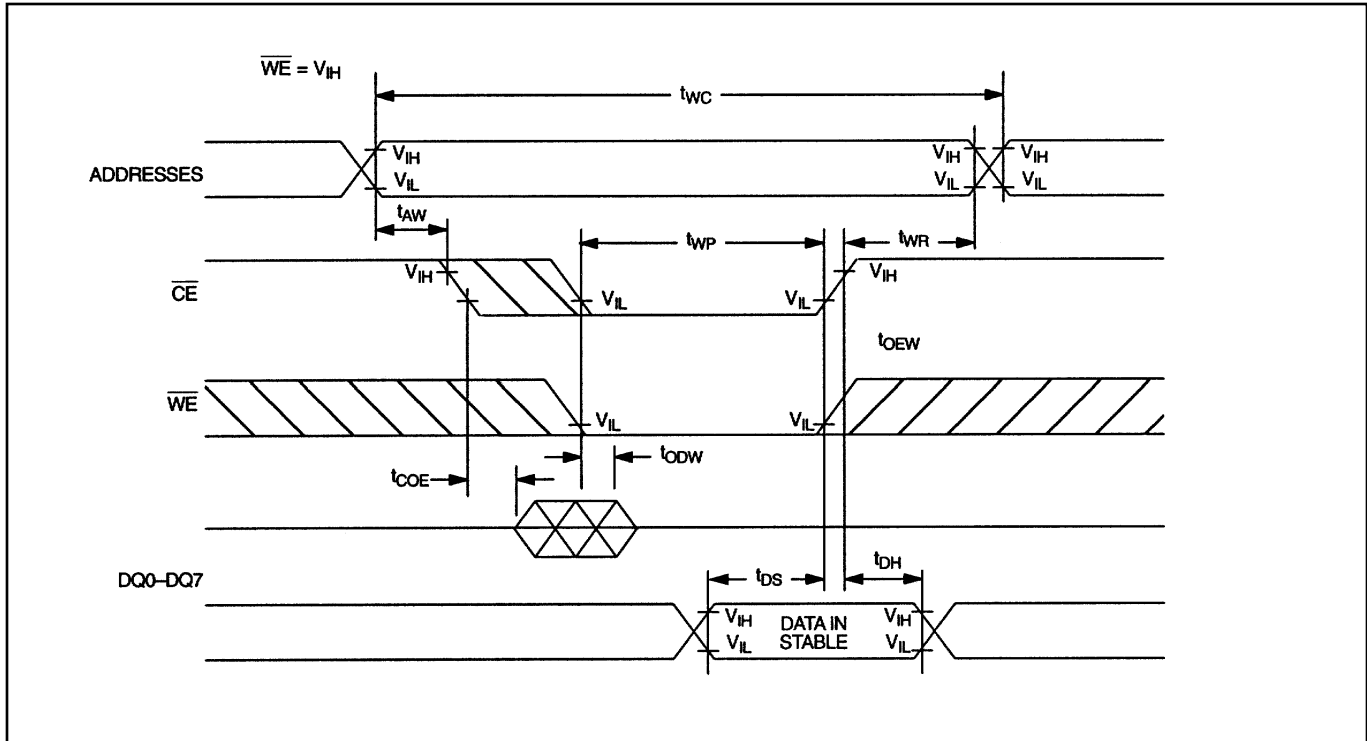

### RESET FOR PHANTOM CLOCK



### READ CYCLE TO PHANTOM CLOCK

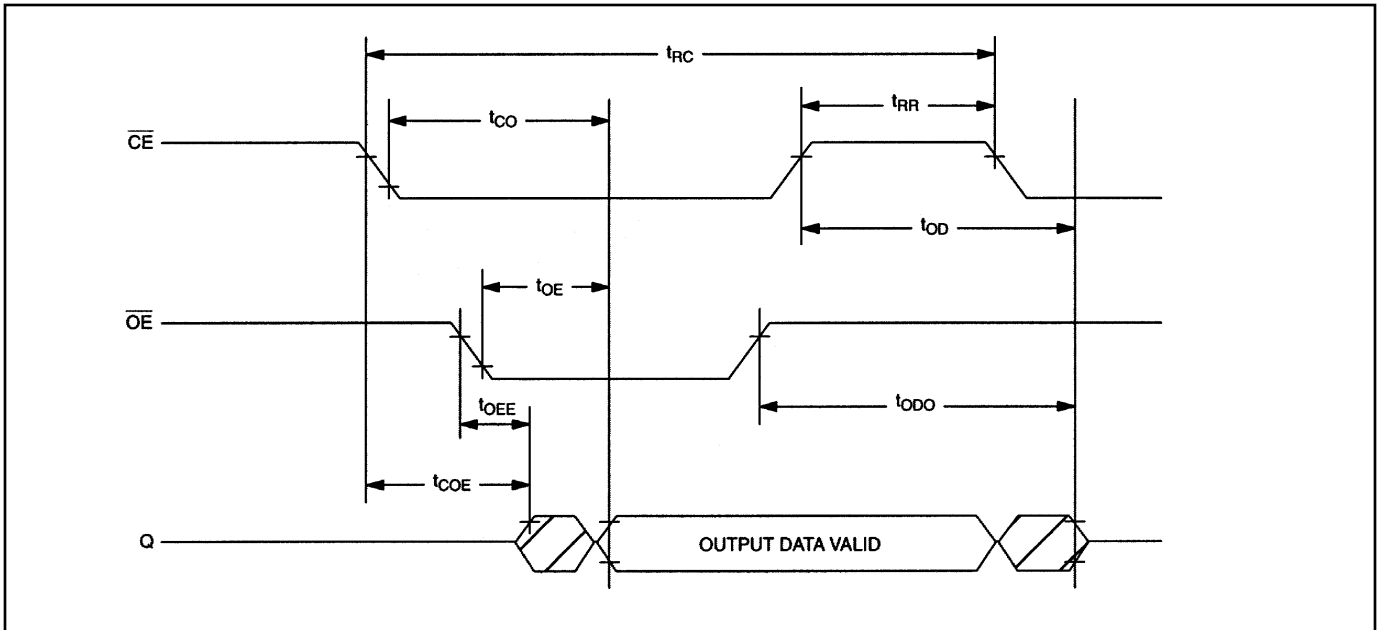

### WRITE CYCLE TO PHANTOM CLOCK

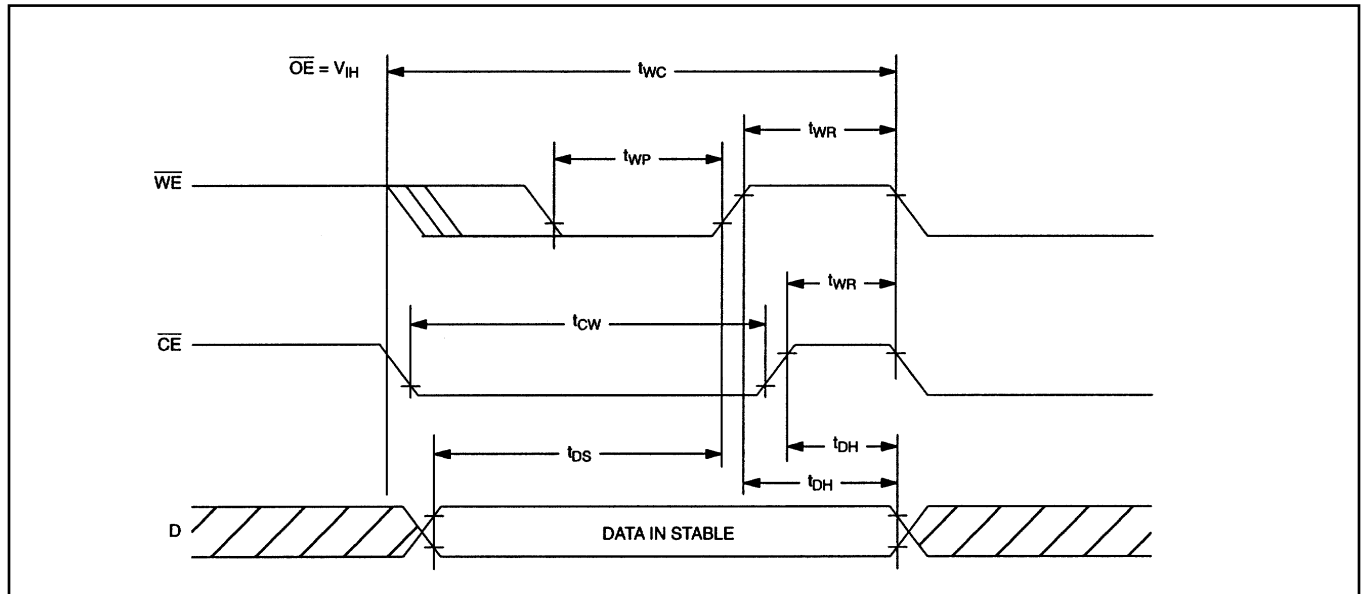



**POWER-DOWN/POWER-UP CONDITION (5V)**

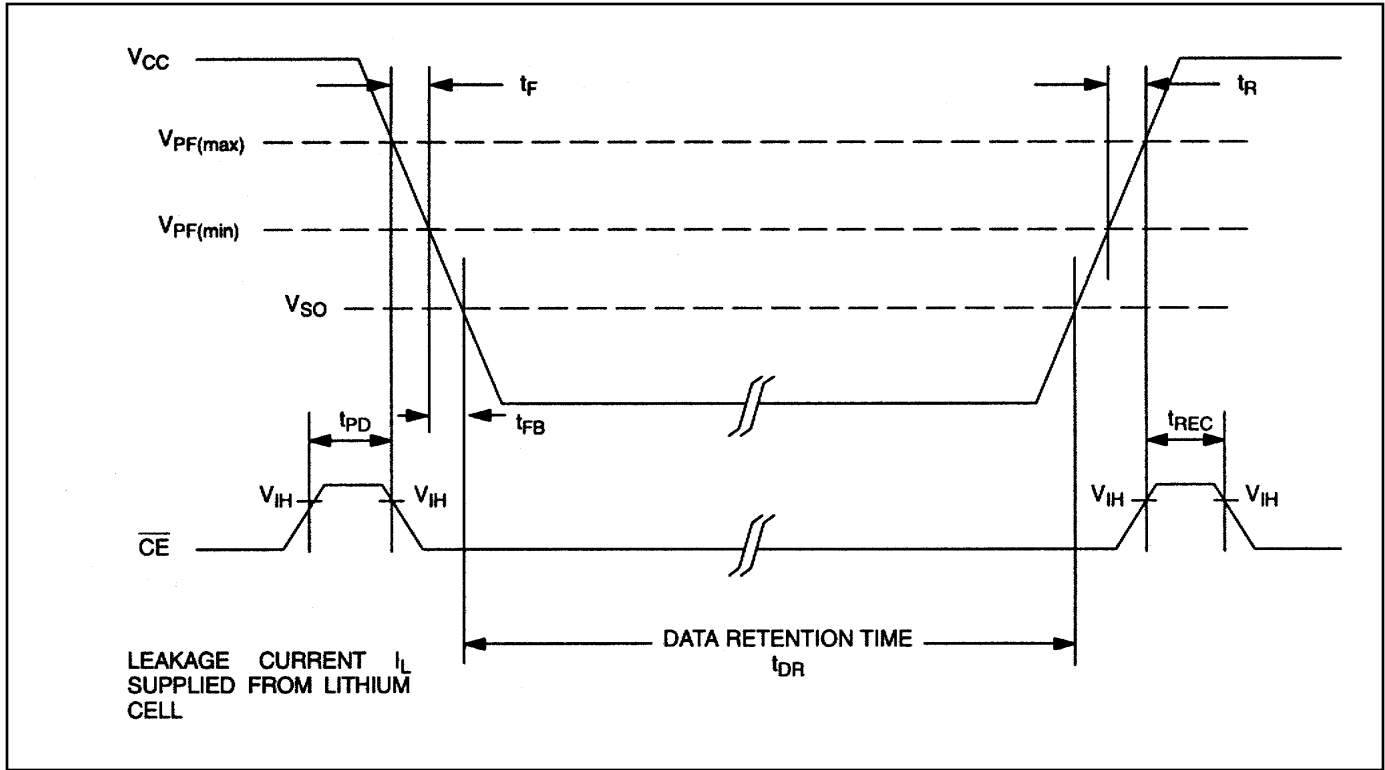

**POWER-DOWN/POWER-UP CONDITION (3.3V)**

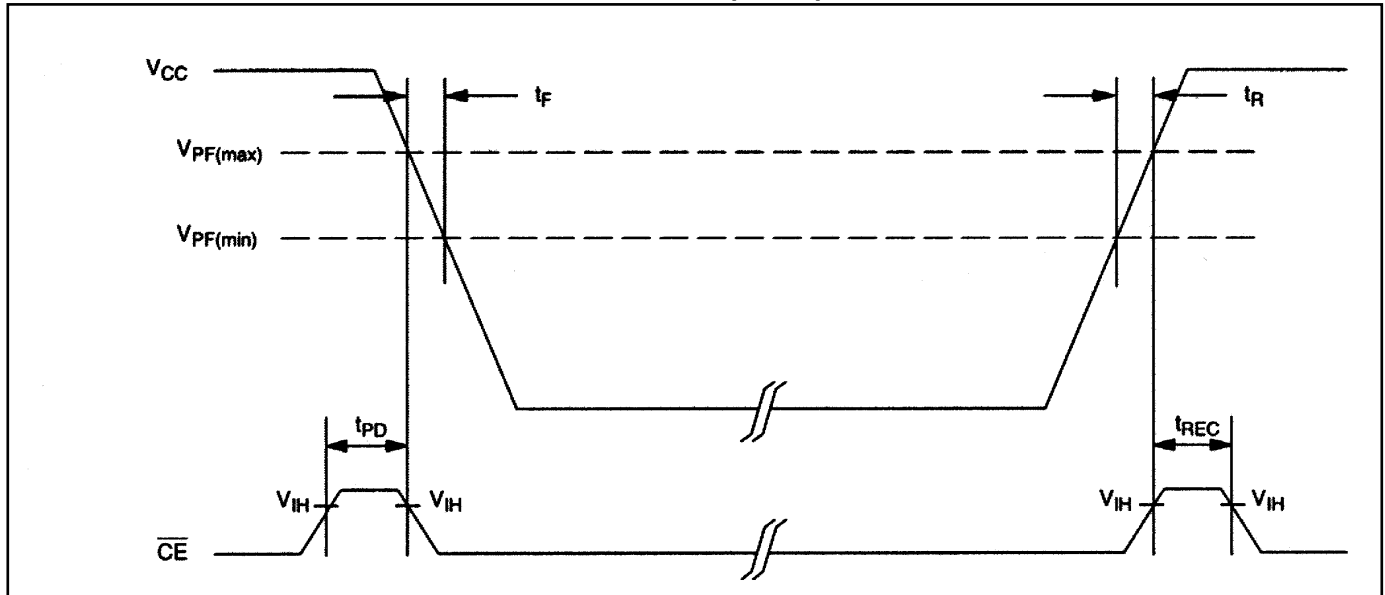

**AC TEST CONDITIONS**

Output Load: 50pF + 1TTL Gate

Input Pulse Levels: 0 to 3V

Timing Measurement Reference Levels

Input: 1.5V

Output: 1.5V

Input Pulse Rise and Fall Times: 5ns

**NOTES:**

- 1)  $\overline{WE}$  is high for a read cycle.
- 2)  $\overline{OE} = V_{IH}$  or  $V_{IL}$ . If  $\overline{CE} = V_{IH}$  during write cycle, the output buffers remain in a high impedance state.
- 3)  $t_{WP}$  is specified as the logical AND of  $\overline{CE}$  and  $\overline{WE}$ .  $t_{WP}$  is measured from the latter of  $\overline{CE}$  or  $\overline{WE}$  going low to the earlier of  $\overline{CE}$  or  $\overline{WE}$  going high.
- 4)  $t_{DH}$ ,  $t_{DS}$  are measured from the earlier of  $\overline{CE}$  or  $\overline{WE}$  going high.
- 5) These parameters are sampled with a 50pF load and are not 100% tested.
- 6) If the  $\overline{CE}$  low transition occurs simultaneously with or later than the  $\overline{WE}$  low transition in Write Cycle 1, the output buffers remain in a high-impedance state during this period.
- 7) If the  $\overline{CE}$  high transition occurs prior to or simultaneously with the  $\overline{WE}$  high transition, the output buffers remain in a high-impedance state during this period.
- 8) If  $\overline{WE}$  is low or the  $\overline{WE}$  low transition occurs prior to or simultaneously with the  $\overline{CE}$  low transition, the output buffers remain in a high impedance state during this period.
- 9) The expected  $t_{DR}$  is defined as cumulative time in the absence of  $V_{CC}$  with the clock oscillator running.
- 10)  $t_{WR}$  is a function of the latter occurring edge of  $\overline{WE}$  or  $\overline{CE}$ .
- 11) Voltages are referenced to ground.
- 12)  $\overline{RST}$  (Pin 1) has an internal pullup resistor.
- 13) RTC modules can be successfully processed through conventional wave-soldering techniques as long as temperature exposure to the lithium energy source contained within does not exceed +85°C. Post-solder cleaning with water-washing techniques is acceptable, provided that ultrasonic vibration is not used. See the PowerCap package drawing for details regarding the PowerCap package.

**PACKAGE INFORMATION**

For the latest package outline information and land patterns (footprints), go to [www.maxim-ic.com/packages](http://www.maxim-ic.com/packages). Note that a “+”, “#”, or “-” in the package code indicates RoHS status only. Package drawings may show a different suffix character, but the drawing pertains to the package regardless of RoHS status.

<b>PACKAGE TYPE</b>	<b>PACKAGE CODE</b>	<b>OUTLINE NO.</b>	<b>LAND PATTERN NO.</b>
32 EDIP	MDT32+2	<a href="#">21-0245</a>	—
34 PWRCP	PC2+3	<a href="#">21-0246</a>	—

**REVISION HISTORY**

<b>REVISION DATE</b>	<b>DESCRIPTION</b>	<b>PAGES CHANGED</b>
11/11	Updated the <i>Features, Ordering Information, AM/PM/12/24-MODE, Absolute Maximum Ratings, and Package Information</i> sections	1, 2, 7, 9, 18