

阅读申明

- 1.本站收集的数据手册和产品资料都来自互联网，版权归原作者所有。如读者和版权方有任何异议请及时告之，我们将妥善解决。
- 2.本站提供的中文数据手册是英文数据手册的中文翻译，其目的是协助用户阅读，该译文无法自动跟随原稿更新，同时也可能存在翻译上的不当。建议读者以英文原稿为参考以便获得更精准的信息。
- 3.本站提供的产品资料，来自厂商的技术支持或者使用者的心得体会等，其内容可能存在描述上的差异，建议读者做出适当判断。
- 4.如需与我们联系，请发邮件到marketing@iczoom.com，主题请标有“数据手册”字样。

Read Statement

1. The datasheets and other product information on the site are all from network reference or other public materials, and the copyright belongs to the original author and original published source. If readers and copyright owners have any objections, please contact us and we will deal with it in a timely manner.
2. The Chinese datasheets provided on the website is a Chinese translation of the English datasheets. Its purpose is for reader's learning exchange only and do not involve commercial purposes. The translation cannot be automatically updated with the original manuscript, and there may also be improper translations. Readers are advised to use the English manuscript as a reference for more accurate information.
3. All product information provided on the website refer to solutions from manufacturers' technical support or users the contents may have differences in description, and readers are advised to take the original article as the standard.
4. If you have any questions, please contact us at marketing@iczoom.com and mark the subject with "Datasheets" .

D/A Converters

Standard 8bit 8ch Type

BH2226FV BH2226F

General Description

The BH2226FV, BH2226F is an 8bit R-2R-type D/A converter with 8 channels. The D/A converter output and serial/parallel conversion function can be switched with one command, and a built-in RESET function ensures that the output voltage at all channels is LOW during power up. A broad power supply voltage range (2.7V-5.5V) is available, providing design flexibility.

Features

- Integrated expansion port function
- Built-in RESET function
- High speed output response characteristics
- 3-line serial interface

Applications

DVCs, DSCs, DVDs, CD-Rs, CD-RWs

Key Specifications

- Power Source Voltage Range: 2.7V to 5.5V
- Number of Channels: 8ch
- Current Consumption: 1.1mA(Typ)
- Differential Non Linearity Error: ± 1.0 LSB
- Integral Non Linearity Error: ± 1.5 LSB
- Output Current Performance: ± 1.0 mA
- Settling Time: 100 μ s(Min)
- Data Transfer Frequency: 10MHz(Max)
- Input Method: CMOS
- Data Latch Method: CSB method
- Operating Temperature Range: -20°C to +85°C

Packages

W(Typ) x D(Typ) x H(Max)

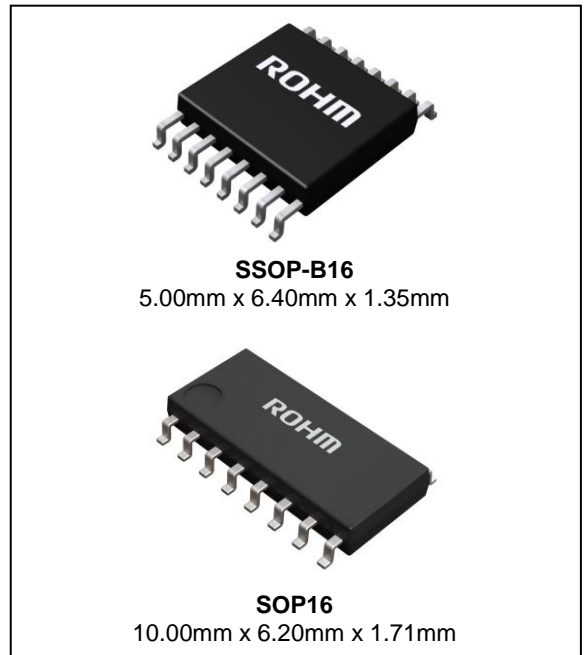

Lineup

Package		Orderable Part Number
SSOP-B16	Reel of 2500	BH2226FV-E2
SOP16	Reel of 2500	BH2226F-E2

Pin Description / Block Diagram

(BH2226FV BH2226F)

No.	Terminal name	Function
1	DA1	Analog output terminal / I/O input output terminal
2	DA2	
3	DA3	
4	DA4	
5	DA5	
6	DA6	
7	DA7	
8	DA8	
9	VCC	Power source terminal
10	RESETB	Reset terminal
11	TEST	Test terminal (normal connected to GND)
12	CSB	Chip select signal input terminal
13	CLK	Serial clock input terminal
14	DI	Serial data input terminal
15	SO	Serial data output terminal
16	GND	Ground terminal

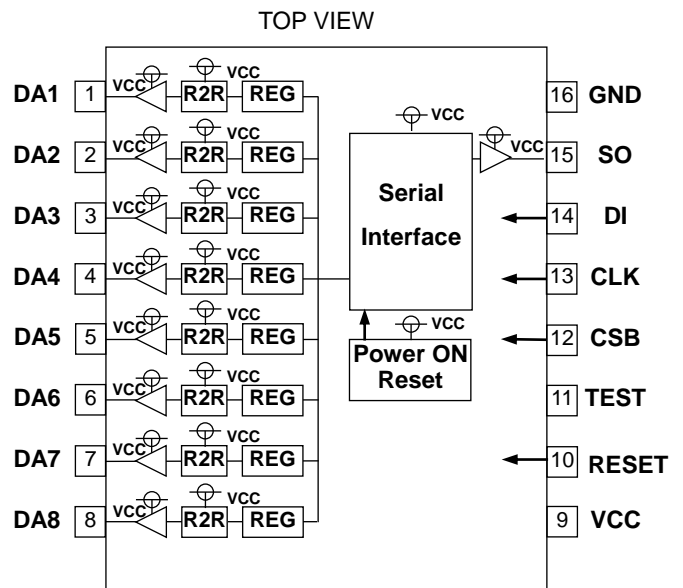

Figure 1. BH2226FV/BH2226F

Absolute Maximum Ratings

Parameter	Symbol	Limit	Unit	Remark
Power Source Voltage	V_{CC}	-0.3 to +7.0	V	-
Terminal Voltage	V_{IN}	-0.3 to V_{CC}	V	-
Storage Temperature Range	Tstg	-55 to +125	°C	-
Power Dissipation	Pd	0.45 (Note 1)	W	BH2226FV
		0.50 (Note 2)	W	BH2226F

(Note 1) Derated at 4.5mW/°C at $T_a > 25^\circ\text{C}$

(Note 2) Derated at 5.0mW/°C at $T_a > 25^\circ\text{C}$

Caution: Operating the IC over the absolute maximum ratings may damage the IC. The damage can either be a short circuit between pins or an open circuit between pins and the internal circuitry. Therefore, it is important to consider circuit protection measures, such as adding a fuse, in case the IC is operated over the absolute maximum ratings.

Recommended Operating Conditions

Parameter	Symbol	Limit			Unit	Remark
		Min	Typ	Max		
VCC Power Source Voltage	V_{CC}	2.7	-	5.5	V	-
Terminal Input Voltage Range	V_{IN}	0	-	V_{CC}	V	-
Analog Output Current	I_{OUT}	-1.0	-	+1.0	mA	-
Operating Temperature Range	T_{opr}	-20	-	+85	°C	-
Serial Clock Frequency	f_{CLK}	-	1.0	10.0	MHz	-
D/A Output Limit Load Capacitance	C_L	-	-	0.1	μF	-

Electrical Characteristics(Unless otherwise specified, $V_{CC}=3.0V$, $R_L=OPEN$, $C_L=0pF$, $T_a=25^{\circ}C$)

Parameter	Symbol	Limit			Unit	Conditions
		Min	Typ	Max		
<Current Consumption>						
VCC System	I_{CC}	-	1.1	2.5	mA	CLK=1MHz, 80H setting
	I_{CCPD}	-	5	20	μA	At power down setting
<Logic Interface>						
L input Voltage	V_{IL}	GND	-	0.6	V	$V_{CC}=5V$
H input Voltage	V_{IH}	2.4	-	V_{CC}	V	$V_{CC}=5V$
Input Current	I_{IN}	-10	-	+10	μA	
L output Voltage	V_{OL}	-	-	0.4	V	$I_{OH}=2.5mA$
H output Voltage	V_{OH}	$V_{CC}-0.4$	-	-	V	$I_{OL}=0.4mA$
<Buffer Amplifier>						
Output Zero Scale Voltage	V_{ZS1}	GND	-	0.1	V	00H setting, at no load
	V_{ZS2}	GND	-	0.3	V	00H setting, $I_{OH}=1.0mA$
Output Full Scale Voltage	V_{FS1}	$V_{CC}-0.1$	-	V_{CC}	V	FFH setting, at no load
	V_{FS2}	$V_{CC}-0.3$	-	V_{CC}	V	FFH setting, $I_{OL}=1.0mA$
<D/A Converter Precision>						
Differential Non Linearity Error	DNL	-1.0	-	+1.0	LSB	Input code 02H to FDH
Integral Non Linearity Error	INL	-1.5	-	+1.5	LSB	Input code 02H to FDH
VCC Power Source Voltage Rise Time	t_{rVCC}	100	-	-	μs	$V_{CC}=0V$ to 2.7V
Power ON Reset Release Voltage	V_{POR}	-	1.9	-	V	

Timing Chart

(Unless otherwise specified, $V_{CC}=3.0V$, $R_L=OPEN$, $C_L=0pF$, $T_a=25^{\circ}C$)

Parameter	Symbol	Limit			Unit	Conditions
		Min	Typ	Max		
CLK L Level Time	t_{CLKL}	50	-	-	ns	
CLK H Level Time	t_{CLKH}	50	-	-	ns	
DI Setup Time	t_{sDI}	20	-	-	ns	
DI Hold Time	t_{hDI}	40	-	-	ns	
Parallel Input Setup Time	t_{sPI}	20	-	-	ns	
Parallel Input Hold Time	t_{hPI}	40	-	-	ns	
CSB Setup Time	t_{sCSB}	50	-	-	ns	
CSB Hold Time	t_{hCSB}	50	-	-	ns	
CSB H Level Time	t_{CSBH}	50	-	-	ns	
D/A Output Settling Time	t_{OUT}	-	-	100	μs	$C_L=50pF, R_L=10k\Omega$
Parallel Output Delay Time	t_{pOUT}	-	-	600	ns	$C_L=50pF, R_L=10k\Omega$
Serial Output Delay Time	t_{sOUT}	-	-	350	ns	$C_L=50pF, R_L=10k\Omega$

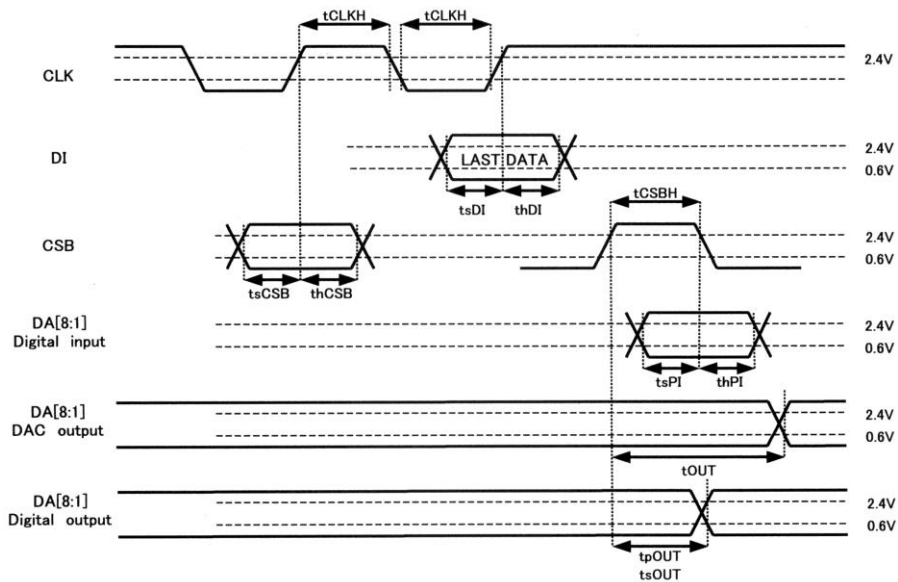

Figure 2

Typical Performance Curves

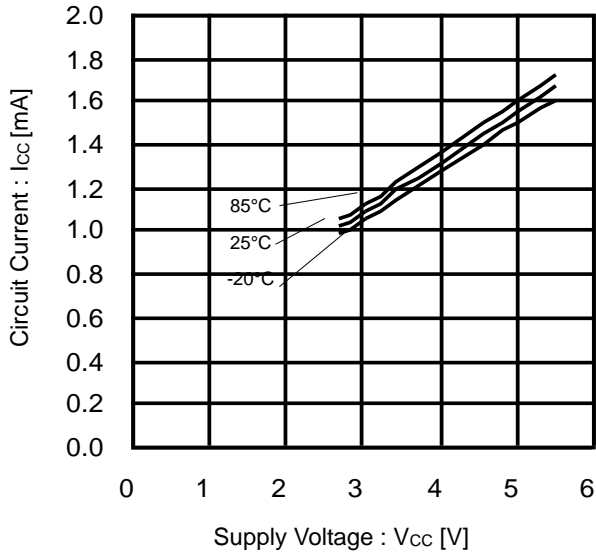

Figure 3. Circuit Current vs Supply Voltage (Active Current Consumption)

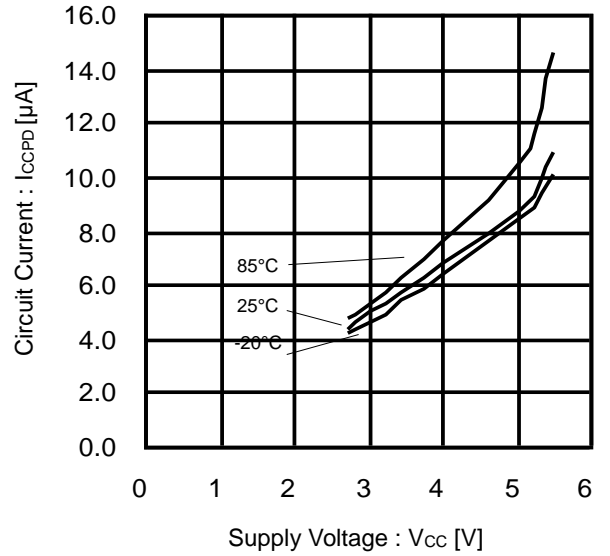

Figure 4. Circuit Current vs Supply Voltage (Current Consumption at Power Down)

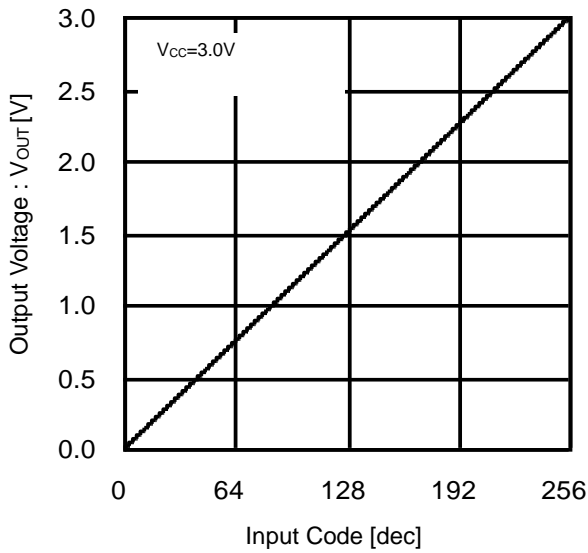

Figure 5. Output Voltage vs Input Code

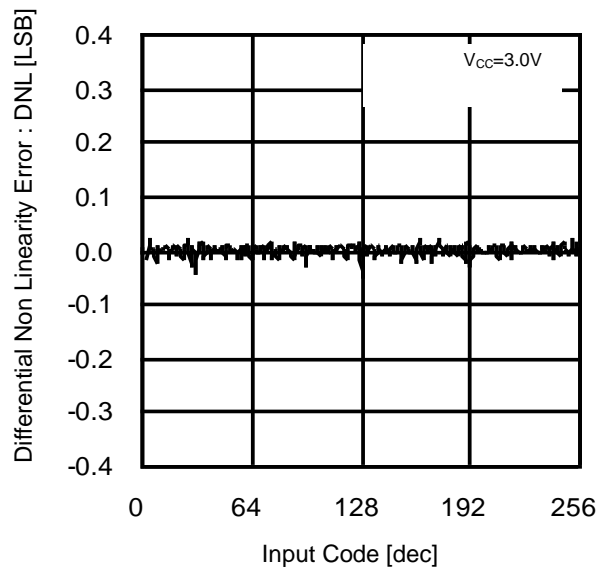

Figure 6. Differential Non Linearity Error vs Input Code

Typical Performance Curves – continued

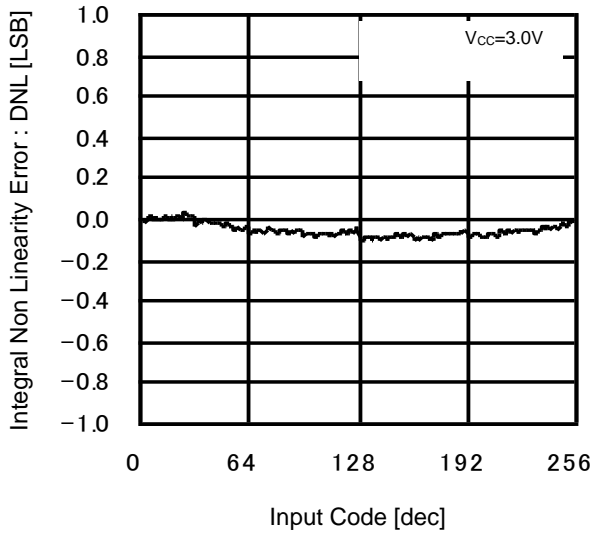

Figure 7. Integral Non Linearity Error vs Input Code

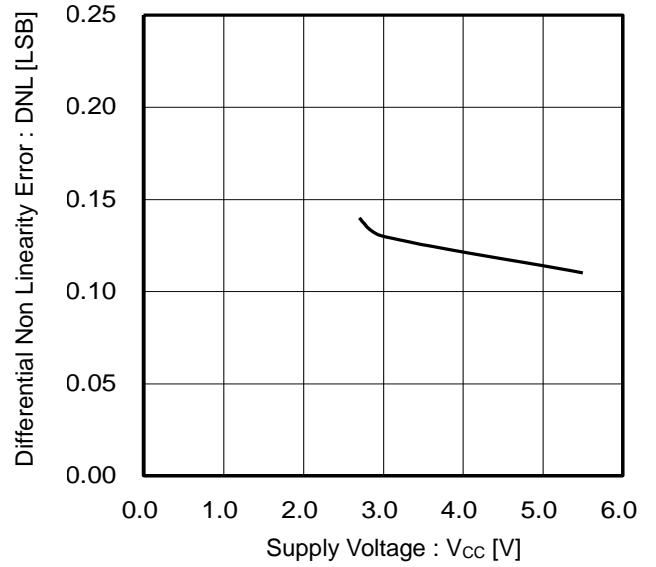

Figure 8. Differential Non Linearity Error vs Supply Voltage

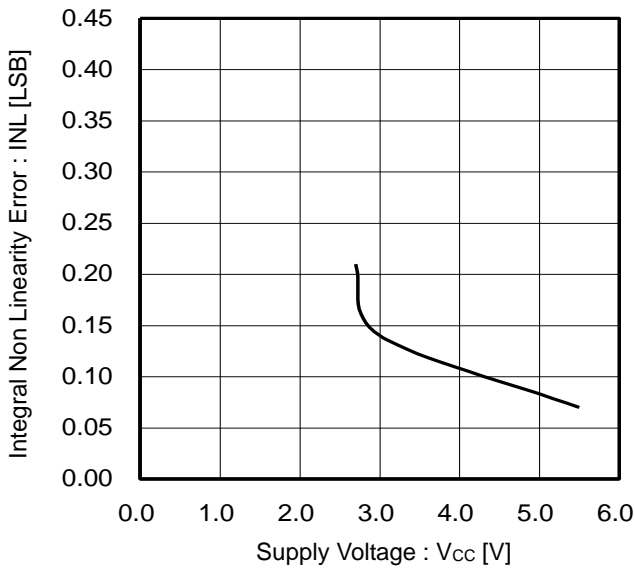

Figure 9. Integral Non Linearity Error vs Supply Voltage

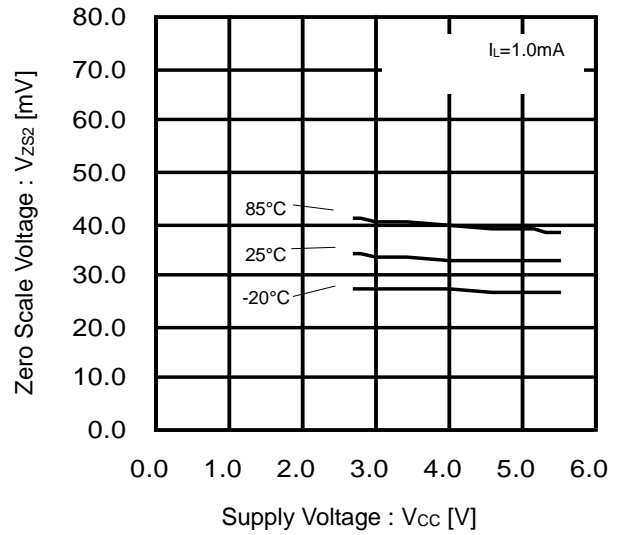

Figure 10. Output Zero Scale Voltage vs Supply Voltage

Typical Performance Curves – continued

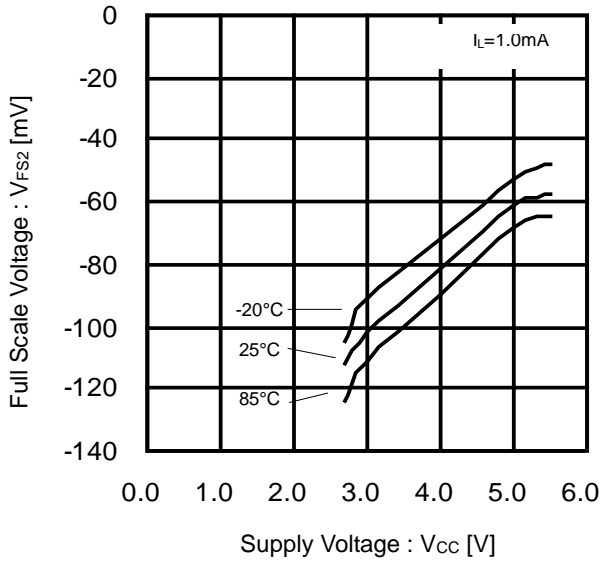

Figure 11. Output Full Scale Voltage vs Supply Voltage

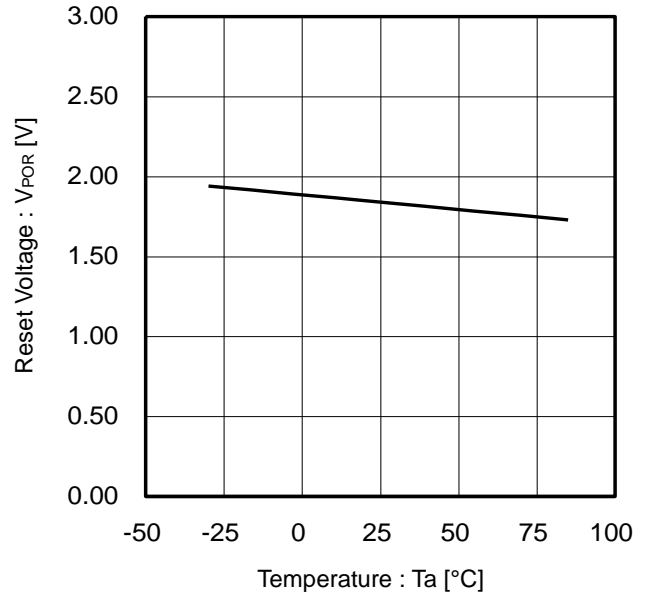

Figure 12. Reset Release Voltage vs Temperature

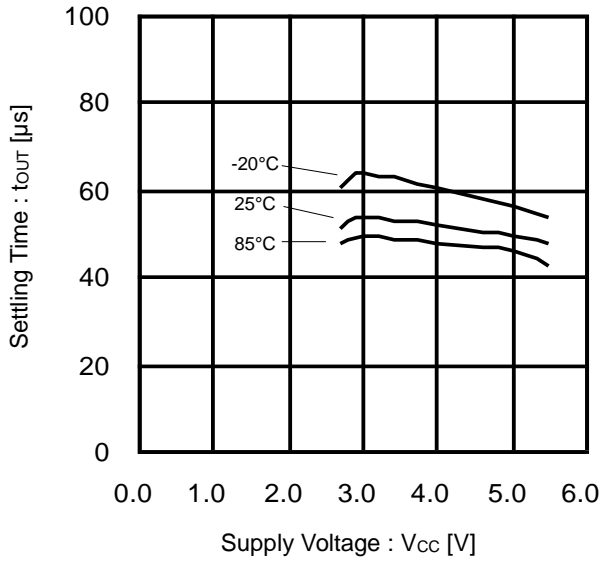

Figure 13. Settling Time vs Supply Voltage

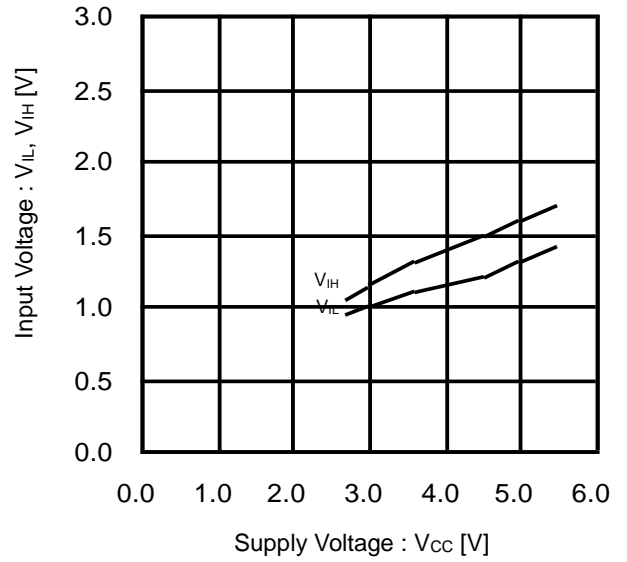

Figure 14. Input Voltage vs Supply Voltage

Application Information

Operation Description

1. Serial Control Interface

The Serial Control Interface is 3-line serial interface 1) CSB, 2) CLK and 3) DI.
 Every command is composed of 12 bits data sent through DI line (MSB first).
 DI data is read every rising edge of the CLK while CSB is LOW.
 Last 12 bits of data are latched when CSB goes HIGH.

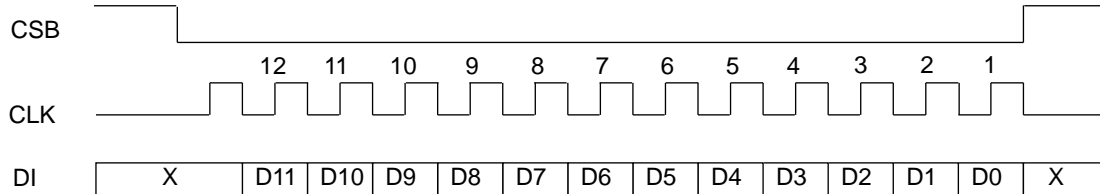

Figure 15

Data Settings

D0	D1	D2	D3	D4	D5	D6	D7	Setting
0	0	0	0	0	0	0	0	At D/A setting : GND
1	0	0	0	0	0	0	0	At D/A setting : (V _{CC} -GND)/256 x 1
0	1	0	0	0	0	0	0	At D/A setting : (V _{CC} -GND)/256 x 2
1	1	0	0	0	0	0	0	At D/A setting : (V _{CC} -GND)/256 x 3
0	0	1	0	0	0	0	0	At D/A setting : (V _{CC} -GND)/256 x 4
0	1	1	1	1	1	1	1	At D/A setting : (V _{CC} -GND)/256 x 254
1	1	1	1	1	1	1	1	At D/A setting : (V _{CC} -GND)/256 x 255

(Note) Default D[7:0]=00h

Channel Settings

D8	D9	D10	D11	Setting
0	0	0	0	Power down setting (default)
0	0	0	1	DA1
0	0	1	0	DA2
0	0	1	1	DA3
0	1	0	0	DA4
0	1	0	1	DA5
0	1	1	0	DA6
0	1	1	1	DA7
1	0	0	0	DA8
1	0	0	1	Power down release
1	0	1	0	Not used
1	0	1	1	Not used
1	1	0	0	I/O D/A select
1	1	0	1	I/O serial ⇒ Parallel
1	1	1	0	I/O parallel ⇒ Serial
1	1	1	1	I/O status setting

Input / Output D/A Selection settings : Each channel can be set for either I/O port or D/A converter output.

0: I/O mode (When I/O mode is selected, set the status as well.)

1: D/A mode (Set the I/O status to output mode.)

D0	D1	D2	D3	D4	D5	D6	D7	Description
DA1	DA2	DA3	DA4	DA5	DA6	DA7	DA8	Corresponding terminals for I/O or D/A selection

I/O Status Setting : Set the status of the I/O input output terminal by D0 to D7.

0: input mode (High-Z status)

1: output mode

D0	D1	D2	D3	D4	D5	D6	D7	Description
DA1	DA2	DA3	DA4	DA5	DA6	DA7	DA8	Corresponding terminals for status setting

2. Command Transmission Procedures

Carry out the following after power ON and just after external reset:

- (1) Power Down Release (2) I/O D/A Select (3) I/O Status Set

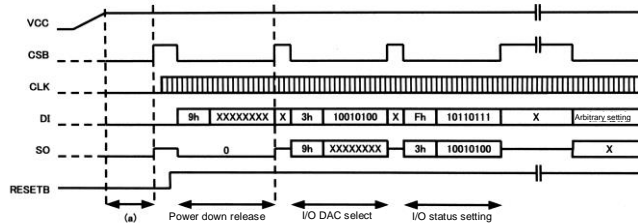

Figure 16

(Note) When power is started, the power ON reset is activated and the internal register initialized. However, as shown in the figure above, in area (a), if CSB cannot be made HIGH and noise is introduced in the control line an error may occur when setting during the rising CSB signal. In such a case, set the external RESETB terminal to LOW and reset when CSB = High.

3. Parallel - Serial Conversion

Parallel data {DA[8:1]} is latched at the first CSB falling edge after setting the parallel serial command.

The data is then serially outputted (MSB first) at SO starting at the 4th falling edge of CLK after CSB goes LOW.

However, please note that the SCLK falling edge between the falling edge of CSB and the rising edge of the first SCLK is not counted (this refers to the encircled falling edge of CLK in the figure below).

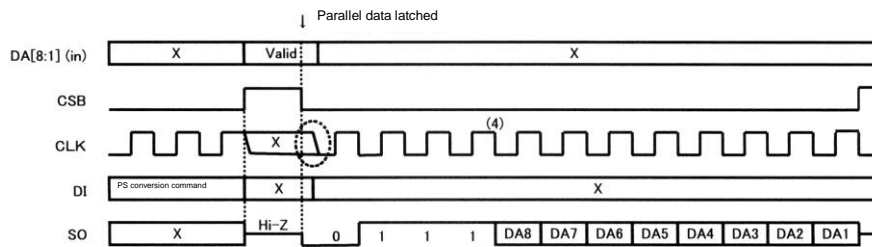

Figure 17

4. Serial - Parallel Conversion

DI serial data is read at the rising edge of CLK.

Parallel data is then outputted at the DA[8:1] terminals after the rising edge of CSB.

When CSB is LOW SO terminal output becomes undefined (just before address setting + data output).

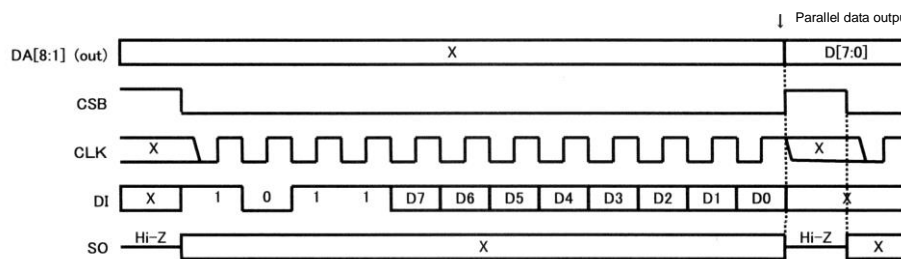

Figure 18

5. D/A Converter Output Setting (Figure 19)

DI serial data is read at the rising edge of CLK.

The D/A converter output is available at the DA terminal after the rising edge of CSB.

When CSB is LOW SO terminal output becomes undefined (just before address setting + data output).

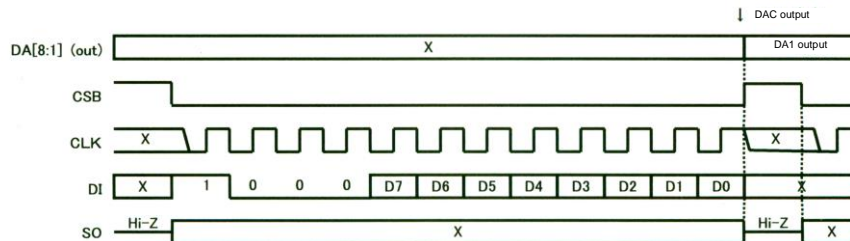

Figure 19

I/O Equivalent Circuit

Terminal	Equivalence Circuit	Terminal	Equivalence Circuit
DA1 DA2 DA3 DA4 DA5 DA6 DA7 DA8		DI CLK CSB TEST RESETB	
		SO	

Operational Notes

1. Reverse Connection of Power Supply

Connecting the power supply in reverse polarity can damage the IC. Take precautions against reverse polarity when connecting the power supply, such as mounting an external diode between the power supply and the IC's power supply pins.

2. Power Supply Lines

Design the PCB layout pattern to provide low impedance supply lines. Separate the ground and supply lines of the digital and analog blocks to prevent noise in the ground and supply lines of the digital block from affecting the analog block. Furthermore, connect a capacitor to ground at all power supply pins. Consider the effect of temperature and aging on the capacitance value when using electrolytic capacitors.

3. Ground Voltage

Ensure that no pins are at a voltage below that of the ground pin at any time, even during transient condition.

4. Ground Wiring Pattern

When using both small-signal and large-current ground traces, the two ground traces should be routed separately but connected to a single ground at the reference point of the application board to avoid fluctuations in the small-signal ground caused by large currents. Also ensure that the ground traces of external components do not cause variations on the ground voltage. The ground lines must be as short and thick as possible to reduce line impedance.

5. Thermal Consideration

Should by any chance the power dissipation rating be exceeded the rise in temperature of the chip may result in deterioration of the properties of the chip. In case of exceeding this absolute maximum rating, increase the board size and copper area to prevent exceeding the Pd rating.

6. Recommended Operating Conditions

These conditions represent a range within which the expected characteristics of the IC can be approximately obtained. The electrical characteristics are guaranteed under the conditions of each parameter.

7. Inrush Current

When power is first supplied to the IC, it is possible that the internal logic may be unstable and inrush current may flow instantaneously due to the internal powering sequence and delays, especially if the IC has more than one power supply. Therefore, give special consideration to power coupling capacitance, power wiring, width of ground wiring, and routing of connections.

8. Operation Under Strong Electromagnetic Field

Operating the IC in the presence of a strong electromagnetic field may cause the IC to malfunction.

9. Testing on Application Boards

When testing the IC on an application board, connecting a capacitor directly to a low-impedance output pin may subject the IC to stress. Always discharge capacitors completely after each process or step. The IC's power supply should always be turned off completely before connecting or removing it from the test setup during the inspection process. To prevent damage from static discharge, ground the IC during assembly and use similar precautions during transport and storage.

10. Inter-pin Short and Mounting Errors

Ensure that the direction and position are correct when mounting the IC on the PCB. Incorrect mounting may result in damaging the IC. Avoid nearby pins being shorted to each other especially to ground, power supply and output pin. Inter-pin shorts could be due to many reasons such as metal particles, water droplets (in very humid environment) and unintentional solder bridge deposited in between pins during assembly to name a few.

11. Unused Input Pins

Input pins of an IC are often connected to the gate of a MOS transistor. The gate has extremely high impedance and extremely low capacitance. If left unconnected, the electric field from the outside can easily charge it. The small charge acquired in this way is enough to produce a significant effect on the conduction through the transistor and cause unexpected operation of the IC. So unless otherwise specified, unused input pins should be connected to the power supply or ground line.

Operational Notes – continued

12. Regarding the Input Pin of the IC

This monolithic IC contains P+ isolation and P substrate layers between adjacent elements in order to keep them isolated. P-N junctions are formed at the intersection of the P layers with the N layers of other elements, creating a parasitic diode or transistor. For example (refer to figure below):

When $GND > Pin A$ and $GND > Pin B$, the P-N junction operates as a parasitic diode.

When $GND > Pin B$, the P-N junction operates as a parasitic transistor.

Parasitic diodes inevitably occur in the structure of the IC. The operation of parasitic diodes can result in mutual interference among circuits, operational faults, or physical damage. Therefore, conditions that cause these diodes to operate, such as applying a voltage lower than the GND voltage to an input pin (and thus to the P substrate) should be avoided.

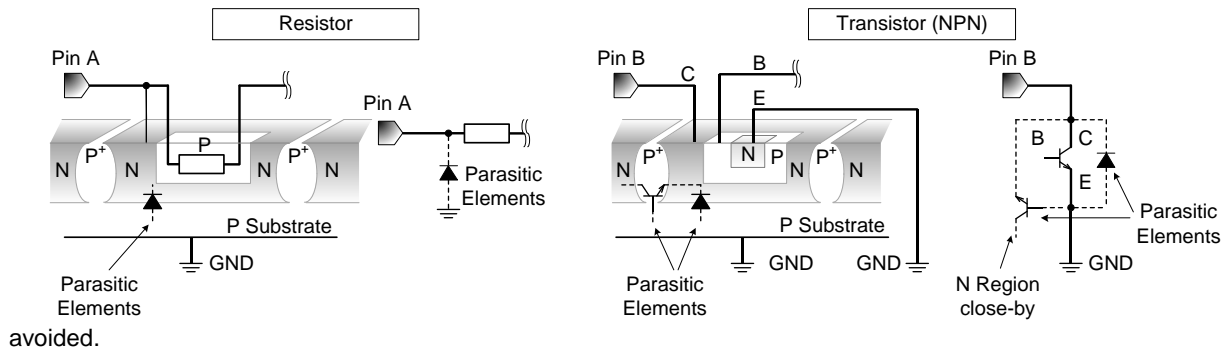

Figure 20. Example of monolithic IC structure

13. Reset Function

The power on reset circuit, which initializes internal settings, may malfunction during abrupt power ons. Therefore, set the time constant so as to satisfy the power source rise time.

14. After power on and after the external reset is in power down status, DA1 to DA8 will be in input mode (all terminals at High-Z).
15. In the case of condition changes in the DA1 to DA8 terminals (i.e. changes from D/A mode to serial-parallel mode, from serial-parallel mode to parallel-serial mode, excluding D/A data and I/O data updates), change both analog and digital settings of High-Z.
16. Connect the RESETB terminal to VCC and set it to High, making sure that it becomes LOW only at reset.
17. Initialization of the serial interface shift register is carried out only by power on reset, or external reset, and is not reset by CSB = High. Therefore, when a specified clock number (12CLK) is not attained during command setting, interrupting processing, transfer regular data once again.
18. The power down function restricts the consumption current in the internal analog circuit. Set it by command. At power down, for channels set to D/A mode, "I/O D/A selection" is changed from "D/A mode" to "I/O mode". Therefore, when the "I/O status setting" of the channel is in input mode, the terminal is in High-Z status and the input becomes unstable and unnecessary current flows. Set the I/O status setting of channel to be in output mode, or set the terminal using resistance.
19. When shifting from PIO use status to D/A use status, a wait time in order to ensure D/A output stability is necessary. Therefore wait for a maximum of 1ms after the "I/O D/A select" command is input. If wait time is problematic, set the D/A setting code to 80hex and change it to the specified code setting.

Ordering Information

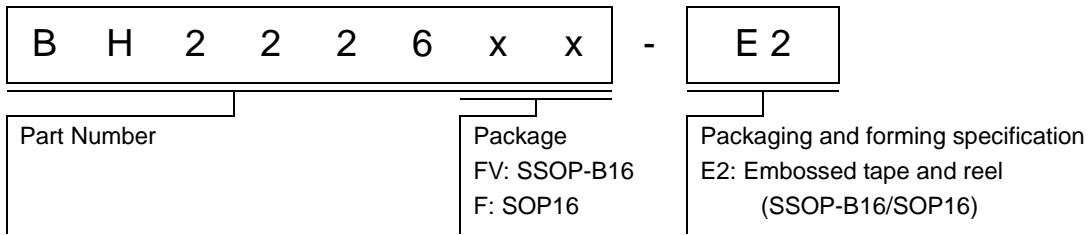

Marking Diagrams

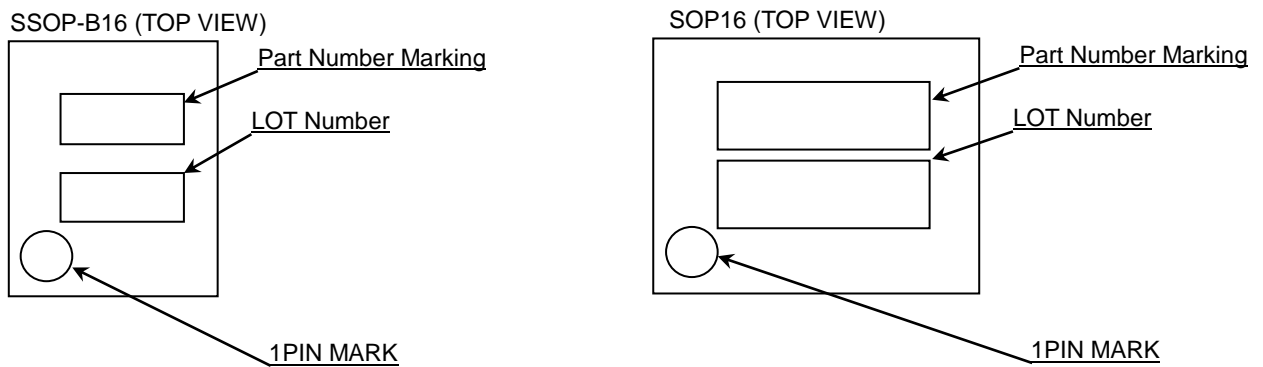

Part Number	Part Number Marking
BH2226FV-E2	H2226
BH2226F-E2	BH2226F

Physical Dimension, Tape and Reel Information

Package Name	SSOP-B16
--------------	----------

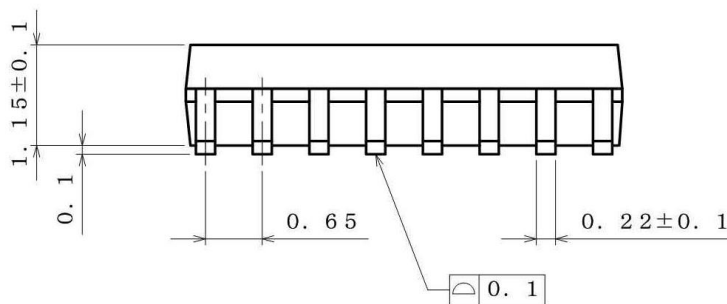
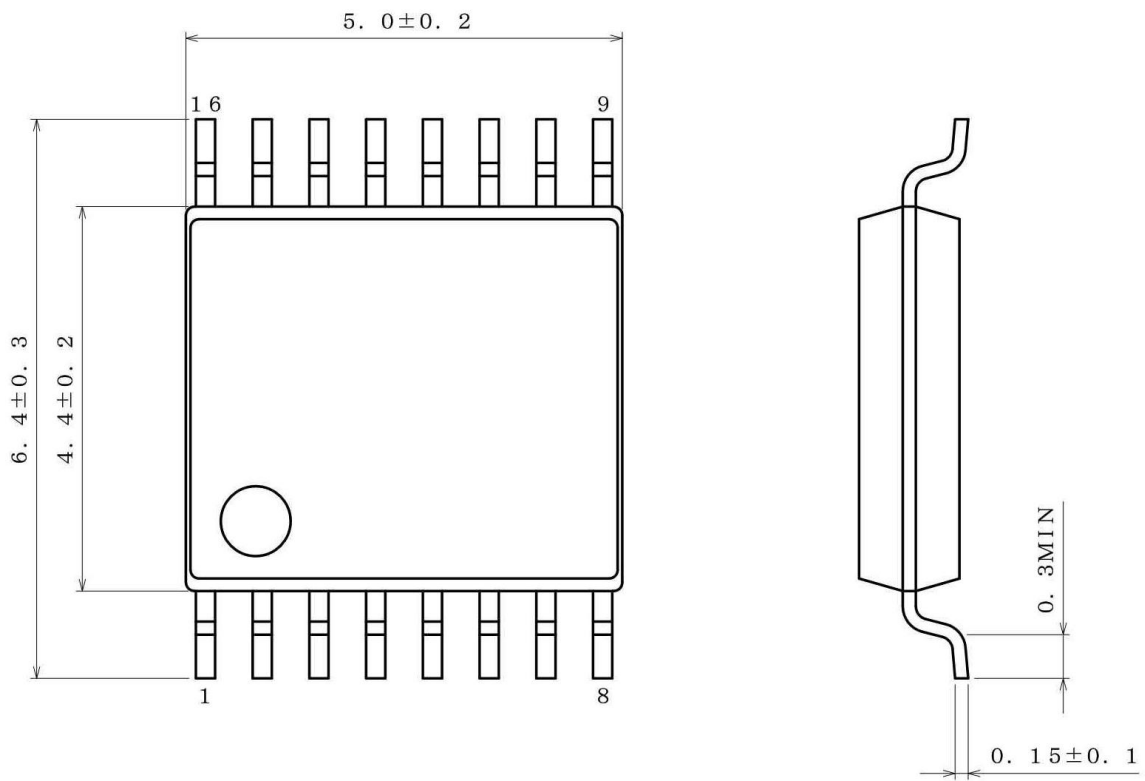

(UNIT : mm)
 PKG : SSOP-B16
 Drawing No. B0771

<Tape and Reel information>

Tape	Embossed carrier tape
Quantity	2500pcs
Direction of feed	E2 (The direction is the 1pin of product is at the upper left when you hold reel on the left hand and you pull out the tape on the right hand)

Reel

1pin

Direction of feed

*Order quantity needs to be multiple of the minimum quantity.

Physical Dimension, Tape and Reel Information – continued

Package Name	SOP16
--------------	-------

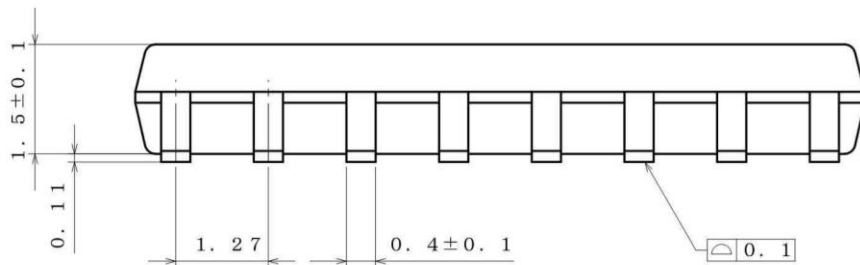
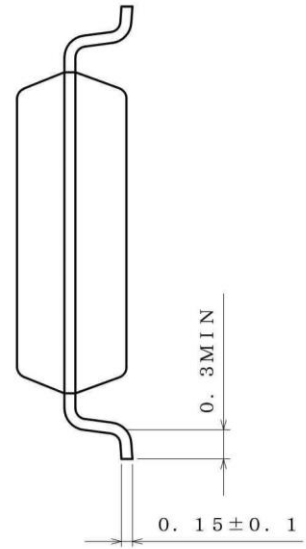
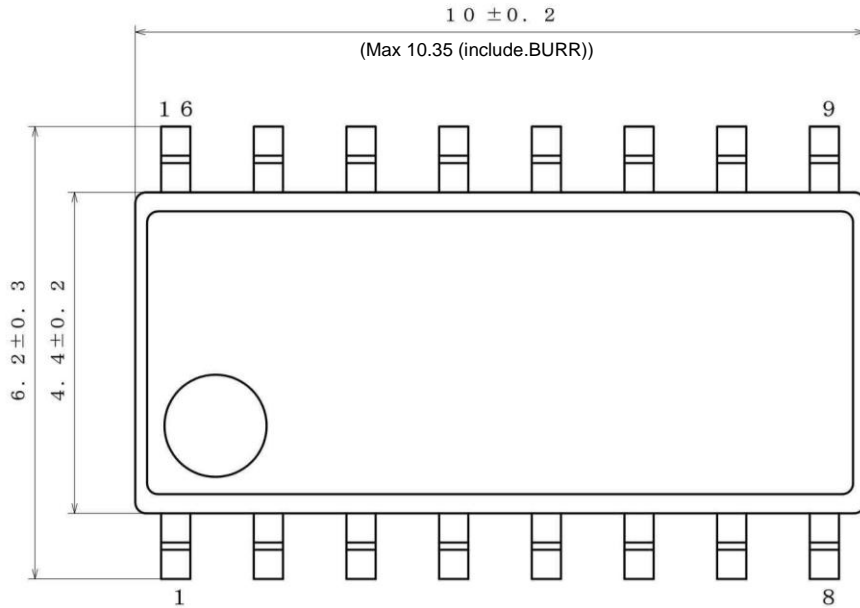

(UNIT : mm)
PKG : SOP16
Drawing No. : EX114-5001

<Tape and Reel information>

Tape	Embossed carrier tape
Quantity	2500pcs
Direction of feed	E2 (The direction is the 1pin of product is at the upper left when you hold reel on the left hand and you pull out the tape on the right hand)

Reel

1pin

Direction of feed

* Order quantity needs to be multiple of the minimum quantity.

Revision History

Date	Revision	Changes
06.Nov.2015	001	New Release

Notice

Precaution on using ROHM Products

- Our Products are designed and manufactured for application in ordinary electronic equipments (such as AV equipment, OA equipment, telecommunication equipment, home electronic appliances, amusement equipment, etc.). If you intend to use our Products in devices requiring extremely high reliability (such as medical equipment ^(Note 1), transport equipment, traffic equipment, aircraft/spacecraft, nuclear power controllers, fuel controllers, car equipment including car accessories, safety devices, etc.) and whose malfunction or failure may cause loss of human life, bodily injury or serious damage to property ("Specific Applications"), please consult with the ROHM sales representative in advance. Unless otherwise agreed in writing by ROHM in advance, ROHM shall not be in any way responsible or liable for any damages, expenses or losses incurred by you or third parties arising from the use of any ROHM's Products for Specific Applications.

(Note1) Medical Equipment Classification of the Specific Applications

JAPAN	USA	EU	CHINA
CLASS III	CLASS III	CLASS II b	CLASS III
CLASS IV		CLASS III	

- ROHM designs and manufactures its Products subject to strict quality control system. However, semiconductor products can fail or malfunction at a certain rate. Please be sure to implement, at your own responsibilities, adequate safety measures including but not limited to fail-safe design against the physical injury, damage to any property, which a failure or malfunction of our Products may cause. The following are examples of safety measures:
 - Installation of protection circuits or other protective devices to improve system safety
 - Installation of redundant circuits to reduce the impact of single or multiple circuit failure
- Our Products are designed and manufactured for use under standard conditions and not under any special or extraordinary environments or conditions, as exemplified below. Accordingly, ROHM shall not be in any way responsible or liable for any damages, expenses or losses arising from the use of any ROHM's Products under any special or extraordinary environments or conditions. If you intend to use our Products under any special or extraordinary environments or conditions (as exemplified below), your independent verification and confirmation of product performance, reliability, etc. prior to use, must be necessary:
 - Use of our Products in any types of liquid, including water, oils, chemicals, and organic solvents
 - Use of our Products outdoors or in places where the Products are exposed to direct sunlight or dust
 - Use of our Products in places where the Products are exposed to sea wind or corrosive gases, including Cl₂, H₂S, NH₃, SO₂, and NO₂
 - Use of our Products in places where the Products are exposed to static electricity or electromagnetic waves
 - Use of our Products in proximity to heat-producing components, plastic cords, or other flammable items
 - Sealing or coating our Products with resin or other coating materials
 - Use of our Products without cleaning residue of flux (even if you use no-clean type fluxes, cleaning residue of flux is recommended); or Washing our Products by using water or water-soluble cleaning agents for cleaning residue after soldering
 - Use of the Products in places subject to dew condensation
- The Products are not subject to radiation-proof design.
- Please verify and confirm characteristics of the final or mounted products in using the Products.
- In particular, if a transient load (a large amount of load applied in a short period of time, such as pulse. is applied, confirmation of performance characteristics after on-board mounting is strongly recommended. Avoid applying power exceeding normal rated power; exceeding the power rating under steady-state loading condition may negatively affect product performance and reliability.
- De-rate Power Dissipation depending on ambient temperature. When used in sealed area, confirm that it is the use in the range that does not exceed the maximum junction temperature.
- Confirm that operation temperature is within the specified range described in the product specification.
- ROHM shall not be in any way responsible or liable for failure induced under deviant condition from what is defined in this document.

Precaution for Mounting / Circuit board design

- When a highly active halogenous (chlorine, bromine, etc.) flux is used, the residue of flux may negatively affect product performance and reliability.
- In principle, the reflow soldering method must be used on a surface-mount products, the flow soldering method must be used on a through hole mount products. If the flow soldering method is preferred on a surface-mount products, please consult with the ROHM representative in advance.

For details, please refer to ROHM Mounting specification

Precautions Regarding Application Examples and External Circuits

1. If change is made to the constant of an external circuit, please allow a sufficient margin considering variations of the characteristics of the Products and external components, including transient characteristics, as well as static characteristics.
2. You agree that application notes, reference designs, and associated data and information contained in this document are presented only as guidance for Products use. Therefore, in case you use such information, you are solely responsible for it and you must exercise your own independent verification and judgment in the use of such information contained in this document. ROHM shall not be in any way responsible or liable for any damages, expenses or losses incurred by you or third parties arising from the use of such information.

Precaution for Electrostatic

This Product is electrostatic sensitive product, which may be damaged due to electrostatic discharge. Please take proper caution in your manufacturing process and storage so that voltage exceeding the Products maximum rating will not be applied to Products. Please take special care under dry condition (e.g. Grounding of human body / equipment / solder iron, isolation from charged objects, setting of Ionizer, friction prevention and temperature / humidity control).

Precaution for Storage / Transportation

1. Product performance and soldered connections may deteriorate if the Products are stored in the places where:
 - [a] the Products are exposed to sea winds or corrosive gases, including Cl₂, H₂S, NH₃, SO₂, and NO₂
 - [b] the temperature or humidity exceeds those recommended by ROHM
 - [c] the Products are exposed to direct sunshine or condensation
 - [d] the Products are exposed to high Electrostatic
2. Even under ROHM recommended storage condition, solderability of products out of recommended storage time period may be degraded. It is strongly recommended to confirm solderability before using Products of which storage time is exceeding the recommended storage time period.
3. Store / transport cartons in the correct direction, which is indicated on a carton with a symbol. Otherwise bent leads may occur due to excessive stress applied when dropping of a carton.
4. Use Products within the specified time after opening a humidity barrier bag. Baking is required before using Products of which storage time is exceeding the recommended storage time period.

Precaution for Product Label

QR code printed on ROHM Products label is for ROHM's internal use only.

Precaution for Disposition

When disposing Products please dispose them properly using an authorized industry waste company.

Precaution for Foreign Exchange and Foreign Trade act

Since concerned goods might be fallen under listed items of export control prescribed by Foreign exchange and Foreign trade act, please consult with ROHM in case of export.

Precaution Regarding Intellectual Property Rights

1. All information and data including but not limited to application example contained in this document is for reference only. ROHM does not warrant that foregoing information or data will not infringe any intellectual property rights or any other rights of any third party regarding such information or data.
2. ROHM shall not have any obligations where the claims, actions or demands arising from the combination of the Products with other articles such as components, circuits, systems or external equipment (including software).
3. No license, expressly or implied, is granted hereby under any intellectual property rights or other rights of ROHM or any third parties with respect to the Products or the information contained in this document. Provided, however, that ROHM will not assert its intellectual property rights or other rights against you or your customers to the extent necessary to manufacture or sell products containing the Products, subject to the terms and conditions herein.

Other Precaution

1. This document may not be reprinted or reproduced, in whole or in part, without prior written consent of ROHM.
2. The Products may not be disassembled, converted, modified, reproduced or otherwise changed without prior written consent of ROHM.
3. In no event shall you use in any way whatsoever the Products and the related technical information contained in the Products or this document for any military purposes, including but not limited to, the development of mass-destruction weapons.
4. The proper names of companies or products described in this document are trademarks or registered trademarks of ROHM, its affiliated companies or third parties.

General Precaution

1. Before you use our Products, you are requested to carefully read this document and fully understand its contents. ROHM shall not be in any way responsible or liable for failure, malfunction or accident arising from the use of any ROHM's Products against warning, caution or note contained in this document.
2. All information contained in this document is current as of the issuing date and subject to change without any prior notice. Before purchasing or using ROHM's Products, please confirm the latest information with a ROHM sales representative.
3. The information contained in this document is provided on an "as is" basis and ROHM does not warrant that all information contained in this document is accurate and/or error-free. ROHM shall not be in any way responsible or liable for any damages, expenses or losses incurred by you or third parties resulting from inaccuracy or errors of or concerning such information.